

Inverter Support Software
FRENIC Loader
Instruction Manual

Copyright © 2004 Fuji Electric FA Components & Systems Co., Ltd.

No part of this publication may be reproduced or copied without prior written permission from Fuji Electric FA Components & Systems Co., Ltd.

All products and company names mentioned in this manual are trademarks or registered trademarks of their respective holders.

The information contained herein is subject to change without prior notice for improvement.

Preface

Thank you for using FRENIC Loader.

This manual provides all the information you will need on Fuji's inverter support utility tool, FRENIC Loader and the related communication protocols and devices supporting its operations. Read this manual carefully for correct use of Loader. This manual, however, does not contain information on the RS485 communications card (option for FRENIC-Mini) or the FRENIC-Mini/Eco series of inverters. For details on these products, refer to the publications listed below.

The table below lists other material related to the use of the FRENIC-Mini/Eco. Read them in conjunction with technical documents related to Fuji's inverters.



User's Manuals and Instruction Manuals

RS485 Communication User's Manual	MEH448
FRENIC-Mini User's Manual	MEH446
FRENIC-Mini Instruction Manual	INR-S147-0791-E
RS485 Communications Card "OPC-C1-RS" Installation Manual	INR-S147-0773
FRENIC-Eco USER'S MANUAL	MEH456
FRENIC-Eco Instruction Manual	INR-S147-0882-E

■ Safety Precautions

Read this manual thoroughly before proceeding with installation, connections (wiring), or operation. Ensure you have sound knowledge of the device and software and have familiarized yourself with all safety information and precautions before proceeding to operate the inverter via FRENIC Loader.

Safety precautions are classified into the following two categories in this manual.

 WARNING	Failure to heed the information indicated by this symbol may result in death or serious injury.
 CAUTION	Failure to heed the information indicated by this symbol may result in minor or light injury and/or substantial property damage.

Wiring and Connection of Cables

 WARNING	
<ul style="list-style-type: none">• Be sure to perform all wiring and cable connections after turning off the power to the inverters and all related devices.	
Risk of electric shock if this warning is not heeded.	

 CAUTION	
<ul style="list-style-type: none">• Do not connect an RS485 communications cable to the RS232C serial COM port without using an RS232C-RS485 communications level converter.	
An accident could occur if this warning is not heeded.	
<ul style="list-style-type: none">• If you connect an RS485 communications cable to the RS485 ports, ensure the pin assignment of device port has been performed correctly. For details, refer to Chapter 1, Section 1.2 "Connecting inverters to a PC."	
An accident or mechanical failure could occur if this warning is not heeded.	

Operation

 WARNING	
<ul style="list-style-type: none">• If you have reset the alarm while any run commands is turned on, the inverter may cause the motor to run unexpectedly.	
An accident or injury could occur if this warning is not heeded.	

Summary of Contents

Preface	i
Chapter 1 Before Using FRENIC Loader	
1.1 Overview.....	1-1
1.1.1 Features.....	1-1
1.1.2 Loader functions	1-1
1.1.3 Warranty	1-2
1.2 Connecting inverters to a PC.....	1-2
1.2.1 Configuring an RS485 communications network	1-2
1.2.2 Example of networking	1-3
1.2.3 Pin assignment for RS485 communications port	1-4
1.2.4 Communications support devices	1-5
[1] Communications level converter.....	1-5
[2] Requirements for the cable.....	1-6
[3] Multi-drop adapter.....	1-6
[4] RS485 communications card (Option for FRENIC-Mini).....	1-6
1.2.5 Noise suppression	1-6
1.3 Installation of FRENIC Loader	1-7
1.3.1 Installation.....	1-7
1.3.2 Uninstalling Loader	1-11
1.4 Settings Before Starting FRENIC Loader	1-12
1.4.1 Function codes setup in the inverter	1-12
1.4.2 Checking the COM port in the PC.....	1-12
1.4.3 Settings on Loader.....	1-14
1.4.3.1 Communications setup	1-16
1.4.3.2 Connection setup.....	1-17
Chapter 2 Functions of FRENIC Loader	
2.1 Top window of FRENIC Loader	2-1
2.2 File	2-2
2.2.1 New	2-2
2.2.2 Open.....	2-2
2.2.3 Print Setup.....	2-3
2.2.4 Exit	2-3
2.3 Menu.....	2-4
2.3.1 Real-time trace—Displaying running status of an inverter in waveforms	2-4
2.3.1.1 Sub-windows.....	2-5
[1] Measuring monitor	2-5
[2] Positioning graphs	2-6
2.3.1.2 Channel configuration	2-6
2.3.1.3 Real-time trace—Advanced setup of analog channels	2-7
2.3.1.4 Real-time trace—Advanced setup of digital channels.....	2-8
2.3.1.5 Real-time trace—Advanced setup of reconfirming the channel setup.....	2-10
2.3.1.6 Real-time trace—Other advanced settings	2-10
2.3.2 Multi-monitor	2-11
[1] Adding/deleting the listed items	2-11
2.3.3 Operation monitor	2-13
2.3.3.1 I/O monitor—Monitor for control input/output signal status of the inverter	2-13
2.3.3.2 System monitor.....	2-13
2.3.3.3 Alarm monitor.....	2-14
2.3.3.4 Meter display.....	2-15
[1] How to setup information to be monitored	2-16
[2] How to setup the advanced settings for analog meters	2-17

2.3.4	Setting function code data	2-18
2.3.4.1	Function code edit.....	2-19
[1]	Read function code data stored in the inverter	2-20
[2]	How to change the function code data.....	2-22
[3]	Writing the function code data into the inverter from Loader.....	2-23
[4]	Writing function codes in to inverters whose rated power inputs or capacities are different each other.....	2-23
[5]	Saving function code data in the PC.....	2-24
[6]	Initializing the function code data stored in an inverter	2-24
[7]	Printing the function code data list.....	2-25
2.3.4.2	Auto-tuning motor parameters	2-26
2.3.4.3	Comparing the function codes	2-27
2.3.4.4	Searching a function code by a character string	2-28
2.3.4.5	File information	2-29
2.3.5	Test-running.....	2-30
2.3.5.1	How to setup the inverter and run the motor using Loader	2-31
2.3.5.2	How to recover Loader whose test-run window cannot monitor inverter status	2-33
2.3.6	Quick access menu	2-35
2.3.7	Option	2-35
2.4	View.....	2-36
2.4.1	Toolbar.....	2-36
2.4.2	Status bar	2-36
2.5	Window.....	2-37
2.5.1	Cascade windows.....	2-37
2.5.2	Tile windows	2-37
2.5.3	Tile vertically windows	2-38
2.5.4	Arrange icons.....	2-38
2.6	Help	2-39
2.6.1	About FRENIC Loader.....	2-39
Chapter 3 Reference Information		
3.1	Troubleshooting.....	3-1
3.2	Specifications of FRENIC Loader.....	3-2

Chapter 1

Before Using FRENIC Loader

This chapter gives you an overview of the inverter support loader software, FRENIC Loader, and provisions for its installation and operation.

Contents

1.1 Overview.....	1-1
1.1.1 Features.....	1-1
1.1.2 Loader functions	1-1
1.1.3 Warranty	1-2
1.2 Connecting inverters to a PC.....	1-2
1.2.1 Configuring an RS485 communications network	1-2
1.2.2 Example of networking	1-3
1.2.3 Pin assignment for RS485 communications port	1-4
1.2.4 Communications support devices	1-5
[1] Communications level converter.....	1-5
[2] Requirements for the cable.....	1-6
[3] Multi-drop adapter.....	1-6
[4] RS485 communications card (Option for FRENIC-Mini).....	1-6
1.2.5 Noise suppression	1-6
1.3 Installation of FRENIC Loader	1-7
1.3.1 Installation.....	1-7
1.3.2 Uninstalling Loader	1-11
1.4 Settings Before Starting FRENIC Loader	1-12
1.4.1 Function codes setup in the inverter	1-12
1.4.2 Checking the COM port in the PC.....	1-12
1.4.3 Settings on Loader.....	1-14
1.4.3.1 Communications setup	1-16
1.4.3.2 Connection setup.....	1-17

1.1 Overview

1.1.1 Features

- FRENIC-Loader enables a PC to support remote operation of inverters either individually or together via the RS485 communications port on the inverter.
- Simplified operation of Loader allows you to easily run/stop the motor, monitor operation status of the inverter, and to manage and set the function code data for the inverter.
- Real-time trace allows you to monitor operation status of the inverters real-time in a graph chart format with data lists, and to save the monitored result in a file that is useful to analyze operation of a system configured with inverters.

1.1.2 Loader functions

The table below provides an overview of FRENIC Loader functions.

Function		Overview	
Real-time trace		Shows operation status of inverters real-time in graph chart format with data lists.	
Multi-monitor		Lists the operation status of inverter(s).	
Operation Status Monitor	I/O monitor	Indicates the I/O terminal status of the selected inverter.	
	System monitor	Indicates the inverter ROM version, maintenance information and etc.	
	Alarm monitor	Indicates the inverter status during alarm mode.	
	Meter display	Indicates the inverter running status in analog meter format.	
Function code settings	Allows you to edit, compare or set the function code data and edit the file information while viewing a list of them. The function code files listed and edited in the Function code edit window are one of the following:		
	Function code edit	Displaying Function codes	Shows the function codes by category--all, in groups (F, E, C or etc.), those whose data settings differ from factory defaults, those selected by the user to show, communications codes, results of comparison, or searching result of the function codes.
		Writing the changed data	Edits the function code data read from the inverter and overwrites new function code data to the inverter.
		Writing data changed from factory defaults	Overwrites only the function code data changed from those set in the inverter as factory defaults.
		Writing all	Overwrites all data to the inverter unconditionally.
		Help (information on function codes)	Shows the meaning of function code data for each code.
		Saving data	Saves the function code data currently listed in the file.
		Printing data	Prints the list of function codes.
	Initialization	Initializes all function code data set in the inverter(s) managed by Loader or currently being edited by Loader.	
	Auto-tuning motors	Obtains motor parameters (%R, %X and no load current I ₀) and save them in the inverter.	
Comparison	Compares the editing code data with those saved in the selected file or set in the selected inverter.		
File information	Displays and sets information such as model and comments related to the file used to save the function code data.		
Test run		Enables the user to run/stop the inverter or set the frequency command and the terminal assignment, and shows the output frequency, drive current and status of programmable I/O terminals.	

1.1.3 Warranty

Limited Warranty	In no event will FUJI Electric be held liable for any damage (including, but not limited to lost profit, suspension or interruption of operations, loss of operational data or other monetary loss) whatsoever resulting from the use of the software or malfunction of the same or from information contained in this document.
------------------	--

1.2 Connecting inverters to a PC

1.2.1 Configuring an RS485 communications network

To configure a network connecting inverters and a PC to run FRENIC Loader, the inverters require the optional RS485 communications card and the PC equipped with an RS232C-RS485 converter or a USB-RS485 converter.

WARNING

- Be sure to perform all wiring and cable connections after turning off the power to the inverters and all related devices.

Risk of electric shock if this warning is not heeded.

CAUTION

- Do not connect an RS485 communications cable to the RS232C serial COM port without using an RS232C-RS485 communications level converter.

An accident could occur if this warning is not heeded.

- If you connect an RS485 communications cable to the RS485 ports, ensure the pin assignment of device port has been performed correctly. For details, refer to Section 1.2.3 "Pin assignment for RS485 communications port."

An accident or mechanical failure could occur if this warning is not heeded.

-  Note
- 1) To minimize the effects of noise separate the signal lines from the power lines. Refer to Subsection 1.2.5 "Noise suppression."
 - 2) You cannot use FRENIC Loader and other hosting equipment such as a PLC or an additional PC concurrently. To use Loader, disconnect the cables of any such equipment from the RS485 port on the inverter.
 - 3) Assign different station addresses to each of the inverters connected.

1.2.2 Example of networking

The block diagram shown below is of a configuration example for FRENIC Loader using a multi-drop adapter and RS485 communications network.

Multi-drop network using RJ-45 connectors

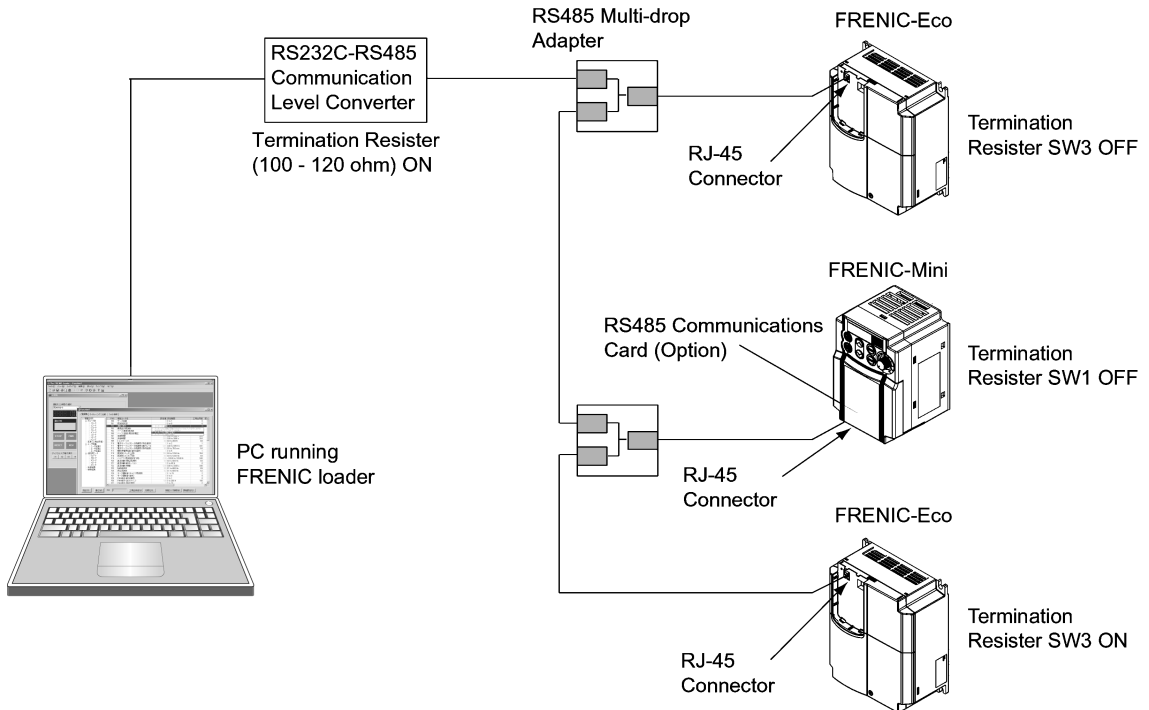

Figure 1.1 RS485 Multi-drop Network using RJ-45 Connectors



- RJ-45 connectors mounted in the inverter and on the RS485 communications card, have pins assigned for feeding power to the keypad used for remote operations. Do not use these pins for any other purposes such as for connection of any equipment other than the keypad. (See Figure 1.2 and Figure 1.3 on the next page.)
- Before preparing parts or devices, to protect parts on the printed circuit board(s) of inverters from damages due to lightning shock, or to keep the network in high noise immunity level, carefully read through the descriptions in Section 1.2.4 "Communications support devices."
- The maximum cable length on the RS485 communications network is 500m.
- Termination resistors of stations at ends of the network should be turned on and ones of others off.

1.2.3 Pin assignment for RS485 communications port

For ease of connection to a standard RS232C-RS485 communications converter FRENIC-Mini/Eco is designed to be compliant with the standard 4 pairs signal line pin assignment for the RJ-45 connector, where a pair of signal lines DX- and DX+ are assigned to No. 4 and 5 pins as shown in Figure 1.2.

Note The power feed lines to the keypad occupy No. 1, 2, 7 and 8 pins. Do not use these pins to connect equipment other than the keypad through this connector, especially be careful for No. 1 and 7 pins.

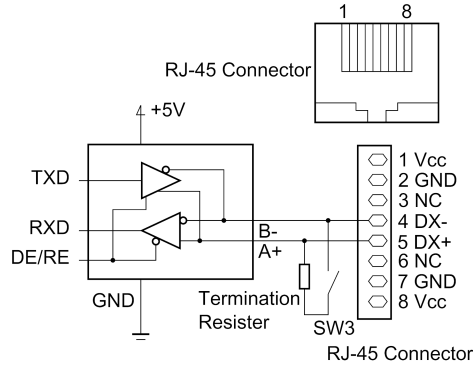

Figure 1.2 Standard RS485 Port and RJ-45 Connector Pin Assignment (FRENIC-Eco)

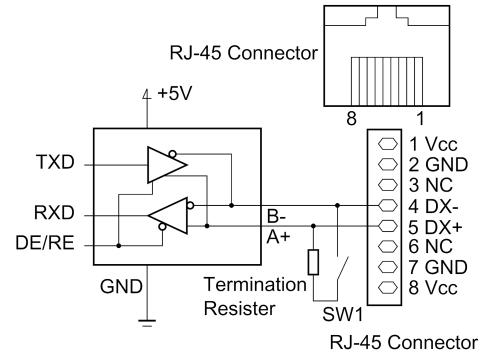

Figure 1.3 Optional RS485 Port and RJ-45 Connector Pin Assignment (FRENIC-Mini)

Table 1.1 RJ-45 Pin Assignment for FRENIC-Eco/Mini

Pins	Assignment for FRENIC-Eco/Mini	Remarks
1	Vcc (+5 V)	Using these pins will cause a short-circuit between the Vcc and GND lines.
2	GND	
3	NC	
4	DX-	A pair of RS485 communications lines
5	DX+	
6	NC	
7	GND	Using these pins will cause a short-circuit between the Vcc and GND lines.
8	Vcc (+5 V)	

1.2.4 Communications support devices

Described below are the devices used to support RS485 communications for FRENIC Loader and precautions for using them.

[1] Communications level converter

Personal computers (PC) are not normally equipped with RS485 communications port but with RS232C ports. To connect inverters to a PC, you will need to use an RS232C-RS485 communications level converter or a USB-RS485 communications converter*. For correct running of the communications facility to support FRENIC-Mini series of inverters, ensure that the converter to be used satisfies the requirements listed below.

*The USB-RS485 converter should be a product that is compatible with the conventional COM port by emulation of a virtual COM port device driver.

Requirements for the recommended communications level converter

- Send/receive switching: Auto-switching by monitoring of send/receive data status at the PC (RS-232C)
- Electric isolation: Electrically isolated with the RS485 port
- Fail-safe: Fail-safe facility*
- Other requirements: Superior noise immunity

* The fail-safe facility refers to a feature that ensures the output circuit of RS485 receiver "High" (logical value = 0) even if the receiver input circuit of RS485 is opened or short-circuited, or all the driver circuits of RS485 are inactive. Refer to the circuit diagram shown below.

Recommended converters

- KS-485PTI (RS232C-RS485 communications level converter)
- USB-485I RJ45-T4P (USB-RS485 interface converter)
- Supplied by SYSTEM SACOM Corporation.

Send/receive switching system

The RS485 communications system of FRENIC-Eco/Mini acts in half-duplex mode (2-wire) so the converter must feature a send/receive switching circuitry. Generally, the switching system may be either one of the following.

- (1) Auto-switching by monitoring of send/receive data
- (2) Switching by RS-232C control signal of RTS or DTR (hardware flow control system)

As FRENIC Loader does not support the hardware flow control system (2) for Microsoft Windows98 or earlier operating system, use the converter that supports the system described in (1).

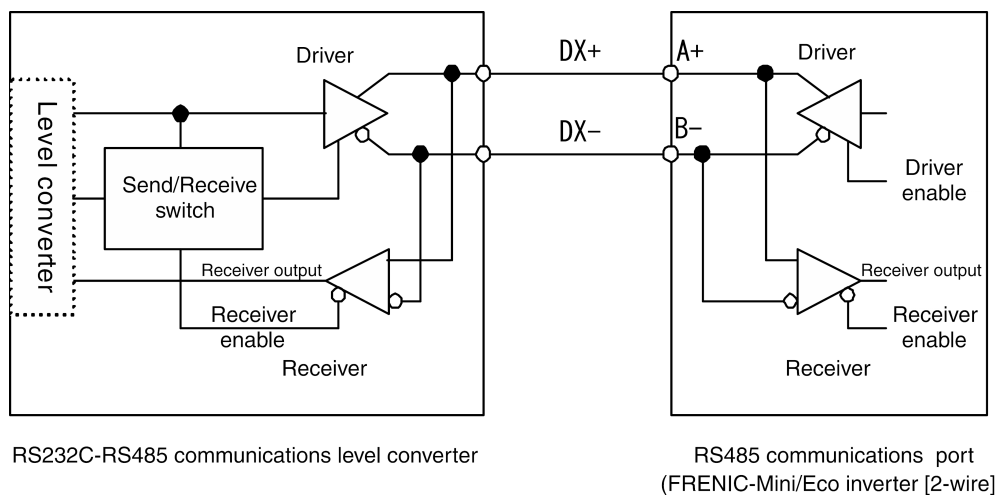

Figure 1.4 Communications Level Conversion

[2] Requirements for the cable

Use a standard LAN cable (US ANSI/TIA/EIA-568A category 5 compliant, straight type) with connection of only the 4 and 5 pins. Do not connect other pins.

[3] Multi-drop adapter

RS485 communications networks for the FRENIC-Eco/Mini inverters utilize 2-wire 10BASE-T LAN cables fitted with an RJ-45 connector at both ends. To connect the inverters to the network in multi-drop basis, use multi-drop adapter for the inverters. Refer to the RS485 Communication User's Manual (MEH448) for details.

Recommended multi-drop adapter

Model MS8-BA-JJJ made by SK KOHKI Co., Ltd.

[4] RS485 communications card (Option for FRENIC-Mini)

Using FRENIC Loader for an RS485 communications network of FRENIC-Mini requires an RS4485 communications card option mentioned below, while no such an option needed for FRENIC-Eco.

RS485 communication card option

OPC-C1-RS

1.2.5 Noise suppression

Depending on the operating environment, Loader may malfunction due to high frequency noise emitted by the inverters. As a countermeasure, route the RS485 communications cable separately so that it is isolated from that of inverter power lines, use a shielded cable, isolate the power lines from signal lines, and/or add an inductance component as shown in the figure below.



Refer to the RS485 Communication User's Manual (MEH448), Chapter 2, Section 2.2.4 "Noise suppression" for details.

Adding inductance components

To suppress or eliminate noise for keeping the network in high noise immunity level, insert inductance components such as choke coils in the signal lines, or pass the RS485 communications cable through a ferrite core ring or wind it around by 2 or 3 turns to keep the impedance of the signal lines high.

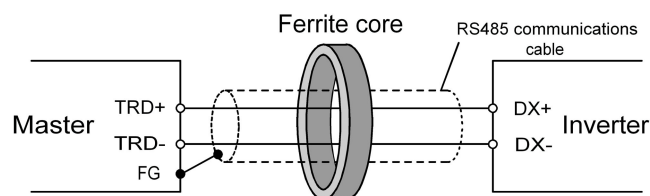

Pass through or wind the cable by 2 or 3 turns.

Figure 1.5 Adding an inductance component

1.3 Installation of FRENIC Loader

1.3.1 Installation

Getting started

Ensure the operating environment meets the following conditions before installing FRENIC Loader.

Check item	Description
Windows operating system	FRENIC Loader runs on Microsoft Windows 98, 2000, or XP.
Free space on the hard disk	5 MB or more free space should be available on your hard disk.
Terminating other applications	Exit all the running applications before installation of Loader.
Uninstalling previous versions	If a previous version of Loader has been installed on your PC, you will need to uninstall it.

Note You should quit the message manager prior to uninstalling any previous version of Loader.

If any previous version of Loader is running, the program of **Message manager** (the icon shown below) may also be running. To quit message manager, right click on its icon in the task tray. If you are unable to quit message manager by right clicking the icon, you will need to shut down or log off Windows.

You can easily identify whether message manager is running or not by checking whether its icon is displayed in the task tray as shown here.



If you uninstall a previous version of Loader while message manager is running and install the new version of Loader, it may not run properly, that is, it may no longer be able to recognize the inverters. If this happens, first remove the folder (including its contents) named FUJI Electric Shared in the file path as shown below, and then reinstall Loader.

C:\Program Files\Common Files\Fuji Electric Shared

(In the file path shown above, "C" represents the drive letter of the partition or hard disk where Windows is installed. If Windows is installed on a different drive in your system, replace "C" with the letter corresponding to that drive.)

Installation

First, copy self-extractable **FRN_Loader.EXE** in your appropriate folder (e.g. Desktop) from the media such as CD-ROM, or by downloading from the Fuji Electric FA Components & Systems website.

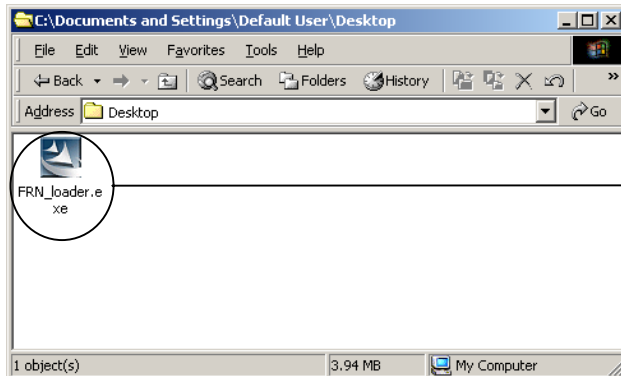

To start the installation, click the **FRN_Loader.EXE** icon.

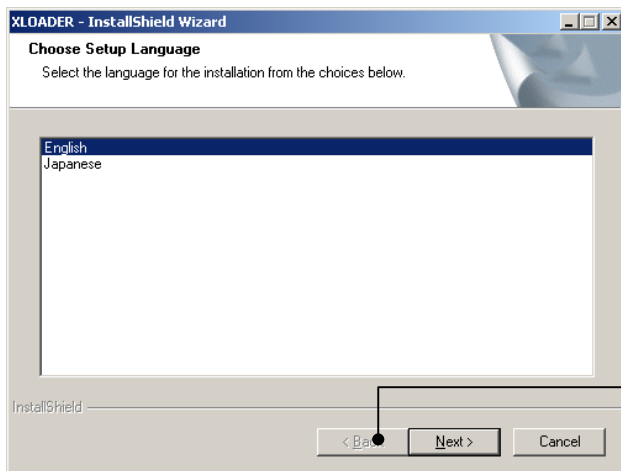

The first screen prompts you to select the language option.

Note that this option does not modify any expression of parts specified by your Windows, but only contents/items defined by Loader, that is, if your Windows is German version, for example, the expression of menu bar, tool bar, indexes and etc will remain in German while contents of Loader panes is expressed in English, even when you have selected English.

Click **N**ext to proceed

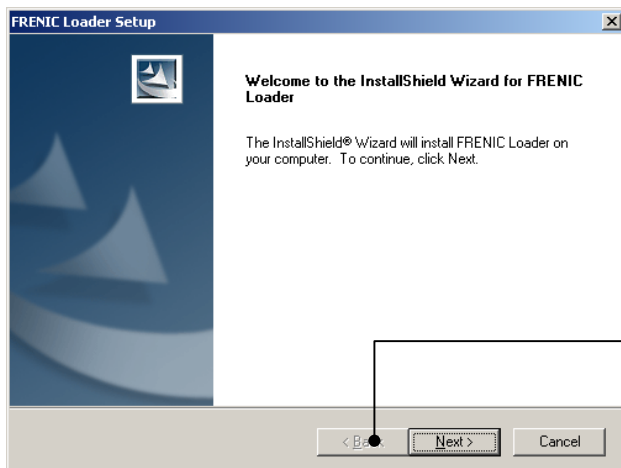

The welcome window will appear.

Click **N**ext to proceed.

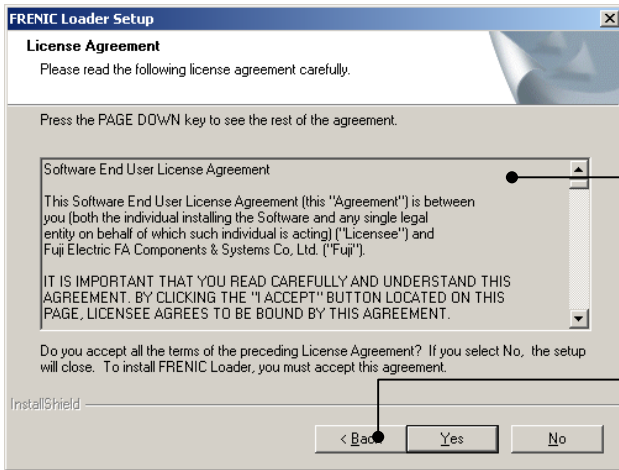

Carefully read the license agreement. Scroll up/down the screen using the Page Up/Down keys or the scroll bar as necessary to view the entire contents of the agreement.

If you agree, click **Yes** to proceed.

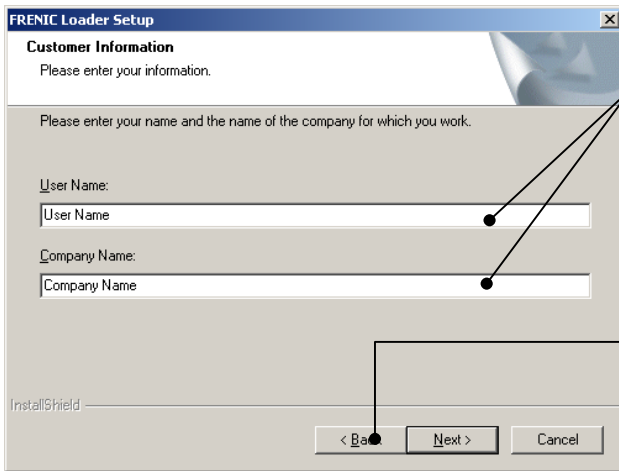

Enter **U**ser name and **C**ompany name.

Once done, click **N**ext to proceed.

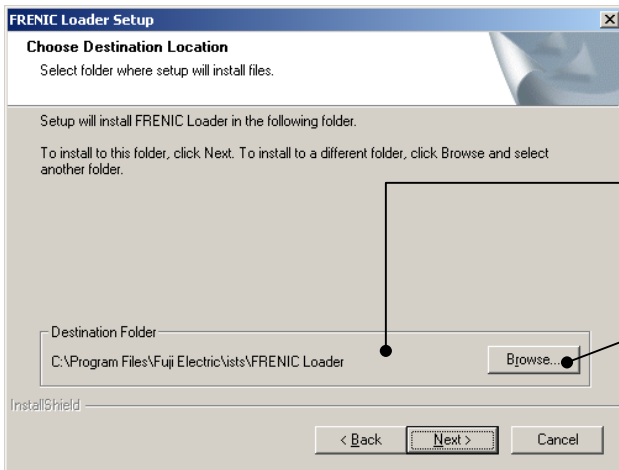

Select the installation folder. A default folder has appeared.

To select a different folder, click **B**rowse...

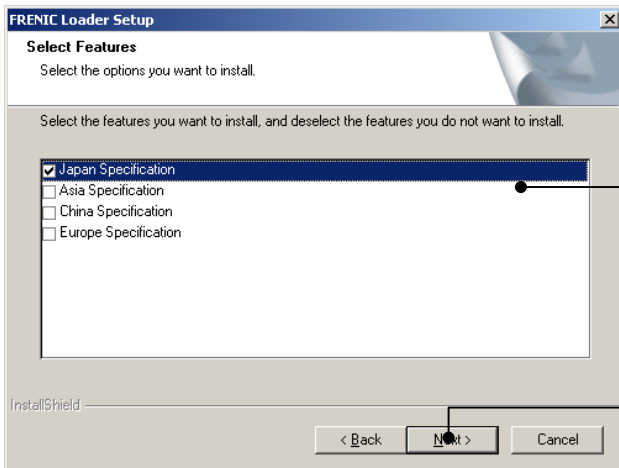

Select the regional specifications of the inverter you want to use. This selection does not have to be the same as Loader's installation language option.

Once done, click **N**ext to proceed.

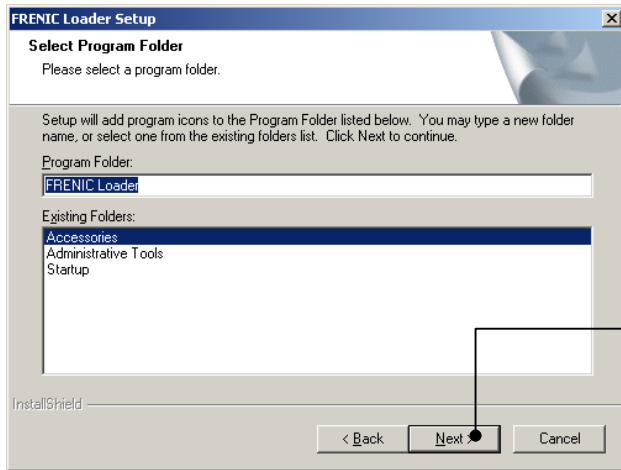

Select the start menu folder that the shortcut to FRENIC Loader is to be added to. Select from an existing folder in the list or create new one.

Once done, click **N**ext to proceed.

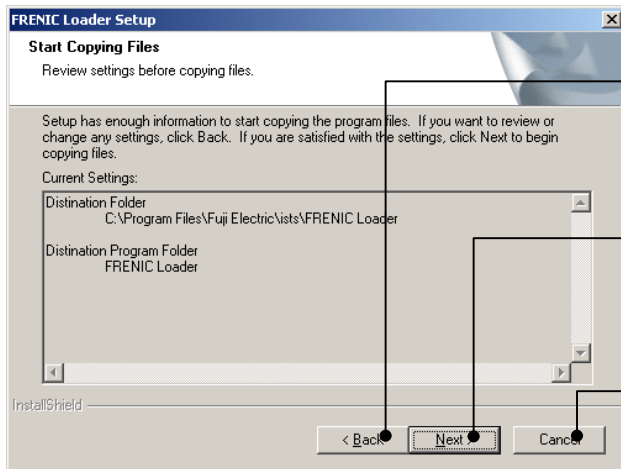

The screen confirming your selection appears.

If you want to change the selection, click **B**ack to return to the previous screen.

Confirm your selection. If OK, click **N**ext to proceed.

To abort the installation click **C**ancel.

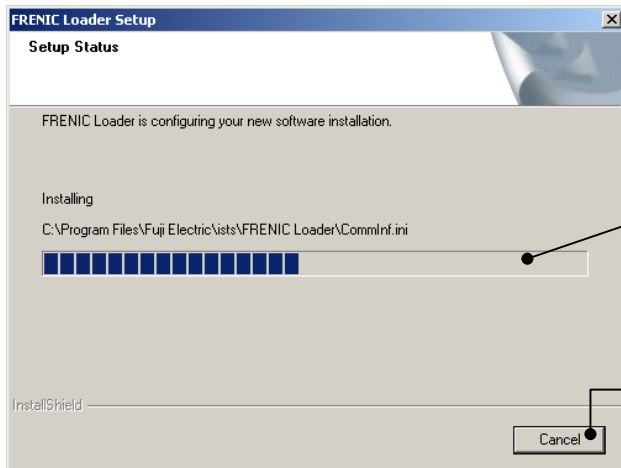

The installation progress bar appears.

To abort the installation click **C**ancel.

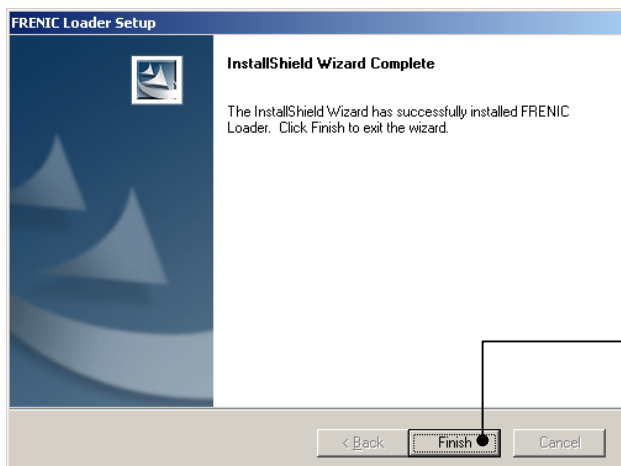

After the installation is complete, the screen at left will appear.

To exit the installation wizard, click **F**inish.

1.3.2 Uninstalling Loader

Before uninstalling

Before uninstalling Loader, ensure that Loader is not running. If it is running, exit it completely before proceeding.

Note You should exit message manager before uninstalling the previous version of Loader. Refer to Section 1.3.1 "Installation" for details.

Uninstalling FRENIC Loader

To call the **FRENIC Loader Uninstall** program, proceed as follows: Start menu on the task bar of Windows → **Program** → **FRENIC Loader** → **FRENIC Loader Uninstall**.

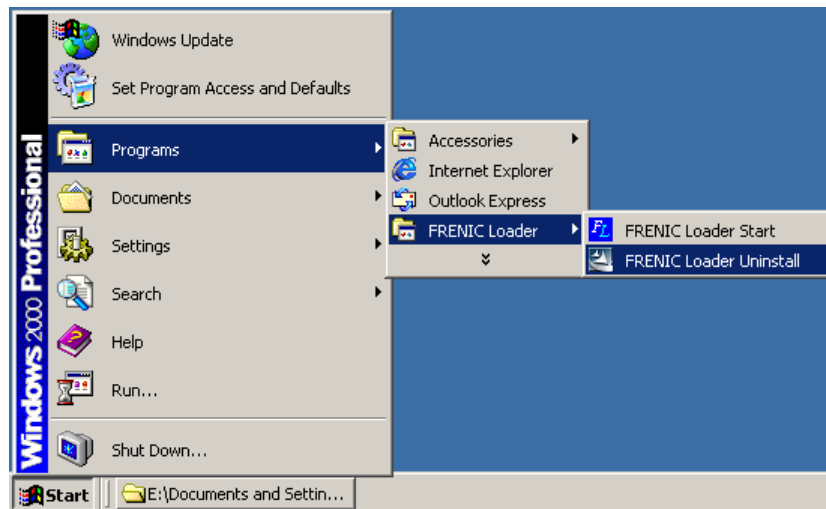

Once clicking here, a confirmation dialog for un-installation will appear. To go ahead and uninstall FRENIC Loader, click **Y**es. The program will run to uninstall it.

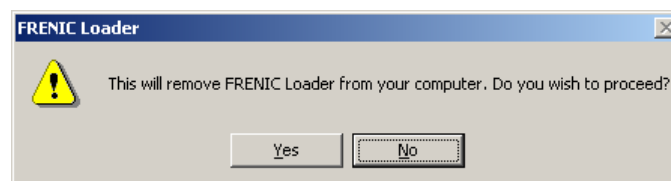

1.4 Settings Before Starting FRENIC Loader

1.4.1 Function codes setup in the inverter

Listed below shows function codes of the inverter in conjunction with operation of FRENIC-Loader. Complete settings of data for the codes, before networking the inverter with Loader.

Function code	Names	Setting range	Factory default
y01	Station address	1 to 255	1
y04	Baud rate	0: 2400 bps 1: 4800 bps 2: 9600 bps 3: 19200 bps 4: 38400 bps (only for Eco)	3
y10	Protocol	0: Modbus RTU 1: Loader 2: Fuji general-purpose inverter	1

Briefing for the codes

y01: Station address

Set the station address of the inverter as same as the value defined in **Connection setup** in Loader.

y04: Baud rate

Set the Baud rate of the inverter as same as the value defined in **Communications setup** in Loader.

y10: Protocol

Set the data to "1: Loader."

1.4.2 Checking the COM port in the PC

Before starting Loader check what COM port in the PC is assigned to the RS232C-RS485 communication level converter.

When you use an RS485-USB interface converter, a free COM port will be automatically assigned to the converter. What follows shows you how to check it in Windows 2000.



Follow **Start** → **Settings** → **Control Panel** and click here to open **Windows 2000 Control Panel** shown in left.

Double-click the **System** icon in the control panel.

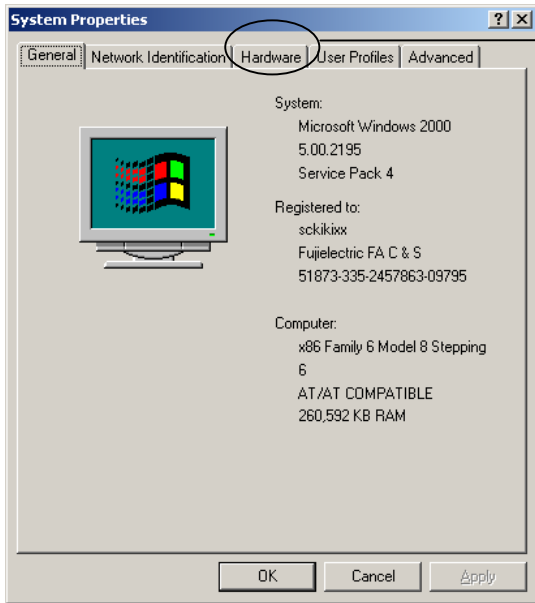

System Properties screen appears.
 Click the **Hardware** tab.
 (You can also call up this screen by right-clicking the **My Computer** icon on your desktop and clicking **Properties**.)

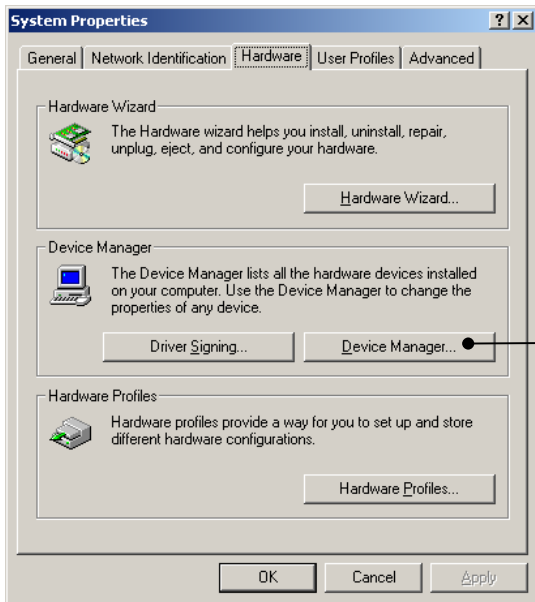

Click **Device Manager...** to check the device status.

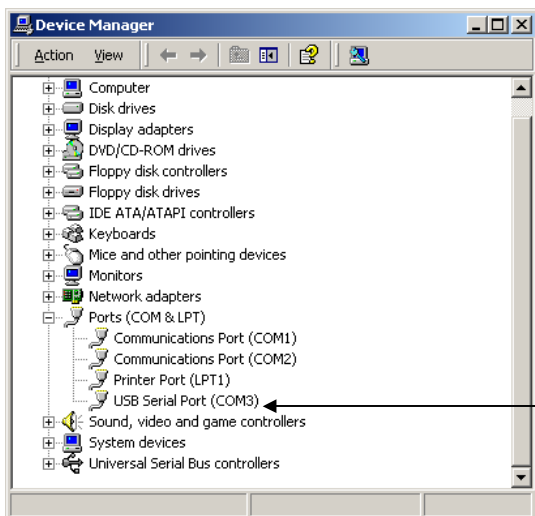

Click  to show details of **Ports (COM & LPT)**.
 Check the numeric n in (COMn).

An example at left shows you that **COM3** is assigned to the **USB Serial Port**, and the port is working properly.

1.4.3 Settings on Loader

You cannot run Loader unless the installation procedure detailed in Section 1.3.1 has been successfully completed. If it is successfully installed you can find **FRENIC Loader** in **Program** of the **Start** menu on the task bar of Windows. Use the following path to locate Loader: **Start** → **Program** → **FRENIC Loader**. Click **Start FRENIC Loader** in the FRENIC Loader menu to start Loader.

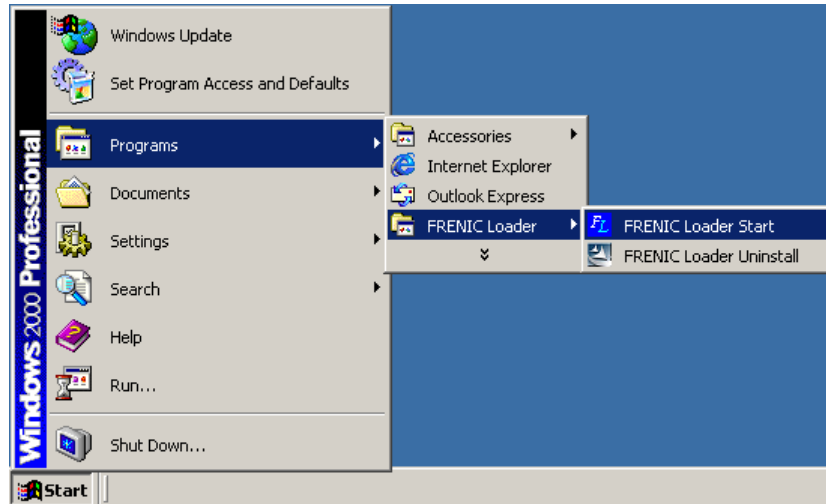



If Loader starts successfully, the **Quick access Menu** as shown below appears first.

This menu contains the 9 quick-start icons for the programs contained in FRENIC Loader. To start a program, simply click its icon. Details of the programs are shown described in Chapter 2.

When using Loader for the first time or after having changed the supporting inverter or the model, you will need to configure the operating environment as follows.

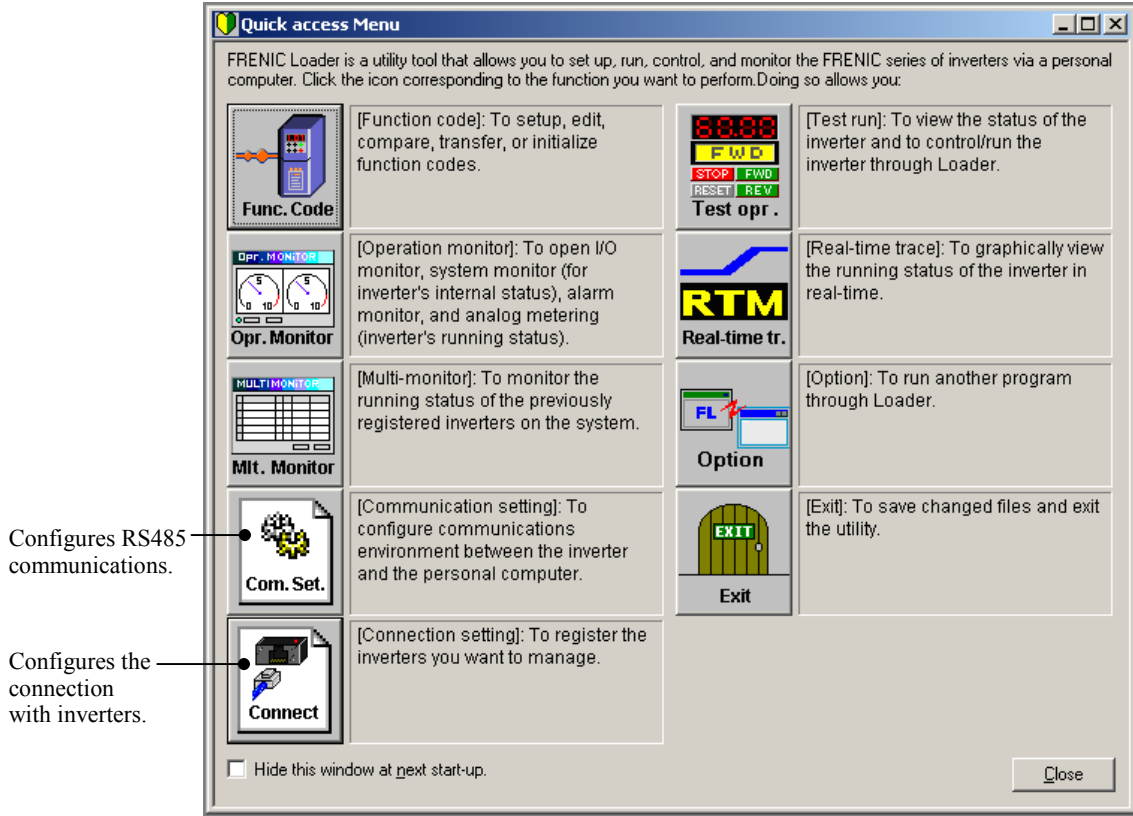
To initiate operating environment configuration, click icon either the **Com. set.** or **Connect** icon on the quick access menu shown above to open the Communication setting dialog or Device connection list window, respectively.



Note When the quick access menu is not opened, click the  icon on the toolbar at the bottom of the main window and contains icons of the programs used in Loader, to open the menu. See the illustration below.



1.4.3.1 Communications setup

Click the **Com. set.** icon on the quick access menu to open the Communication setting dialog. Select the desired communications parameters by clicking the down arrow of the combo-box, referring to the guides shown below.

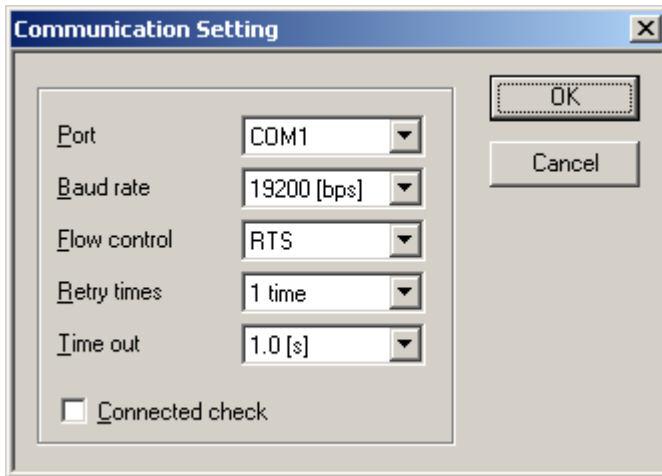

Retry times

Select the number of times for retry upon failure of a transmission. If a large number is selected, the feasibility of successful transmission may be high. Note that, however, it may take a long time to show failure of the transmission after retrying.

The recommended setting is one or more.

Timeout

If no inverter responds within the time selected in the **Timeout** combo-box, the communications error dialog automatically opens. The shorter timeout setting, the faster the dialog will open. Too short a timeout selection may result in a transmission error even if the transmission is successful due to too lengthy an internal processing time of the inverter. If Loader is managing a single inverter, the recommended timeout is 2 seconds. For 2 or more inverters, it should be 2 multiplied by number of the inverters.

Port

Select the PC's serial port connecting the RS232C-RS485 communications level converter. (See Section 1.4.2 "Checking the COM port in the PC.")

Baud rate

The rate should be identical to that of the inverter. The recommended rate is 19200 bps. If the transmission between the PC and inverter is erratic due to noise or other factors, however, you will need to slow down the rate.

Flow control

As Loader does not support flow control, no setting is required. Flow control refers to a system using the RS232C hardware control signal to switch send/receive of RS485 signals. Refer to Section 1.2.4, "[1] Communications level converter" for details.

Connected check

This refers to a feature that monitors communication status between the inverters registered by the Device connection list and Loader. To enable it, click the check box. If enabled, the inverter automatically checks the communications and displays the status on the status bar of Loader top window. When even only one of the registered inverters does not communicate normally, the response time becomes very long if this function is enabled. Remove any such inverter from the Device connection list.

After finishing the selection click **OK** to save your settings and exit Communication setting.

1.4.3.2 Connection setup

Click the **Connect** icon on the left row of the **Quick access Menu**. The Device connection list window pops up as shown below.

Or, click **Setup** on the menu bar to display the pull-down menu. In this pull-down menu, click **Connection Setup...** to open the Device connection list window shown below.

The window lists the inverters available for the RS485 communications network in the Equipment name column and its station address in the RS485 address column, row by row. Click to select the row listing the inverter you want to modify or add to the network and click **Advanced...**, or double-click the row. Then, the Advanced dialog shown below will appear.

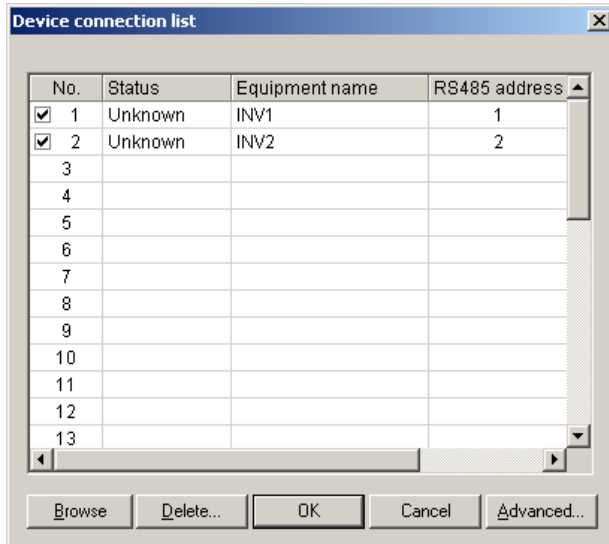

Selection of inverters to be monitored

To make an inverter enable to be monitored put a mark in the box located at the left end column of the list.

Following buttons allow you to perform advanced settings.

Browse

Use this to check whether a link between Loader and the inverter is established. The result will be listed in the communications Status column.

Delete

Use this to disable the inverter listed in the table for being monitored. This allows you to hide the inverter beyond Loader monitoring. For doing so click the inverter to select and click **Delete**.

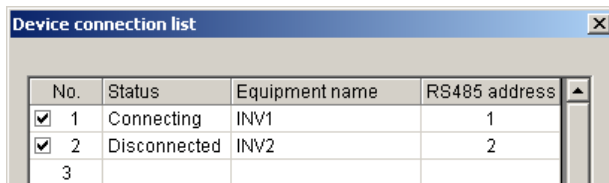

Advanced...

Another way to make inverters enabled to be monitored by Loader as follows.

Click a row of the list to register an inverter, and click **Advanced...**. Then, the **Advanced** dialog at right pops up.

Fill the **Equipment name** and **RS485 address** boxes in the dialog and click **OK**. To cancel your entry or selection click **Cancel**.

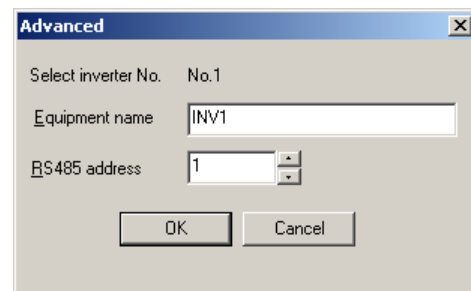

After finishing the selection, click the **OK** button to save the setting and exit connection setup.

Chapter 2

Functions of FRENIC Loader

This chapter contains descriptions of typical functions of FRENIC Loader.

Contents

2.1	Top window of FRENIC Loader	2-1
2.2	File	2-2
2.2.1	New	2-2
2.2.2	Open	2-2
2.2.3	Print Setup	2-3
2.2.4	Exit	2-3
2.3	Menu	2-4
2.3.1	Real-time trace—Displaying running status of an inverter in waveforms	2-4
2.3.1.1	Sub-windows	2-5
[1]	Measuring monitor	2-5
[2]	Positioning graphs	2-6
2.3.1.2	Channel configuration	2-6
2.3.1.3	Real-time trace—Advanced setup of analog channels	2-7
2.3.1.4	Real-time trace—Advanced setup of digital channels	2-8
2.3.1.5	Real-time trace—Advanced setup of reconfirming the channel setup	2-10
2.3.1.6	Real-time trace—Other advanced settings	2-10
2.3.2	Multi-monitor	2-11
[1]	Adding/deleting the listed items	2-11
2.3.3	Operation monitor	2-13
2.3.3.1	I/O monitor—Monitor for control input/output signal status of the inverter	2-13
2.3.3.2	System monitor	2-13
2.3.3.3	Alarm monitor	2-14
2.3.3.4	Meter display	2-15
[1]	How to setup information to be monitored	2-16
[2]	How to setup the advanced settings for analog meters	2-17
2.3.4	Setting function code data	2-18
2.3.4.1	Function code edit	2-19
[1]	Read function code data stored in the inverter	2-20
[2]	How to change the function code data	2-22
[3]	Writing the function code data into the inverter from Loader	2-23
[4]	Writing function codes in to inverters whose rated power inputs or capacities are different each other	2-23
[5]	Saving function code data in the PC	2-24
[6]	Initializing the function code data stored in an inverter	2-24
[7]	Printing the function code data list	2-25

2.3.4.2	Auto-tuning motor parameters	2-26
2.3.4.3	Comparing the function codes	2-27
2.3.4.4	Searching a function code by a character string	2-28
2.3.4.5	File information	2-29
2.3.5	Test-running	2-30
2.3.5.1	How to setup the inverter and run the motor using Loader	2-31
2.3.5.2	How to recover Loader whose test-run window cannot monitor inverter status	2-33
2.3.6	Quick access menu	2-35
2.3.7	Option	2-35
2.4	View	2-36
2.4.1	Toolbar	2-36
2.4.2	Status bar	2-36
2.5	Window	2-37
2.5.1	Cascade windows	2-37
2.5.2	Tile windows	2-37
2.5.3	Tile vertically windows	2-38
2.5.4	Arrange icons	2-38
2.6	Help	2-39
2.6.1	About FRENIC Loader	2-39

2.1 Top window of FRENIC Loader

The top window shown below appears first when you start FRENIC Loader. Normally, the top window contains a quick access menu that appears when it starts up. (The menu is omitted in the example shown below.)

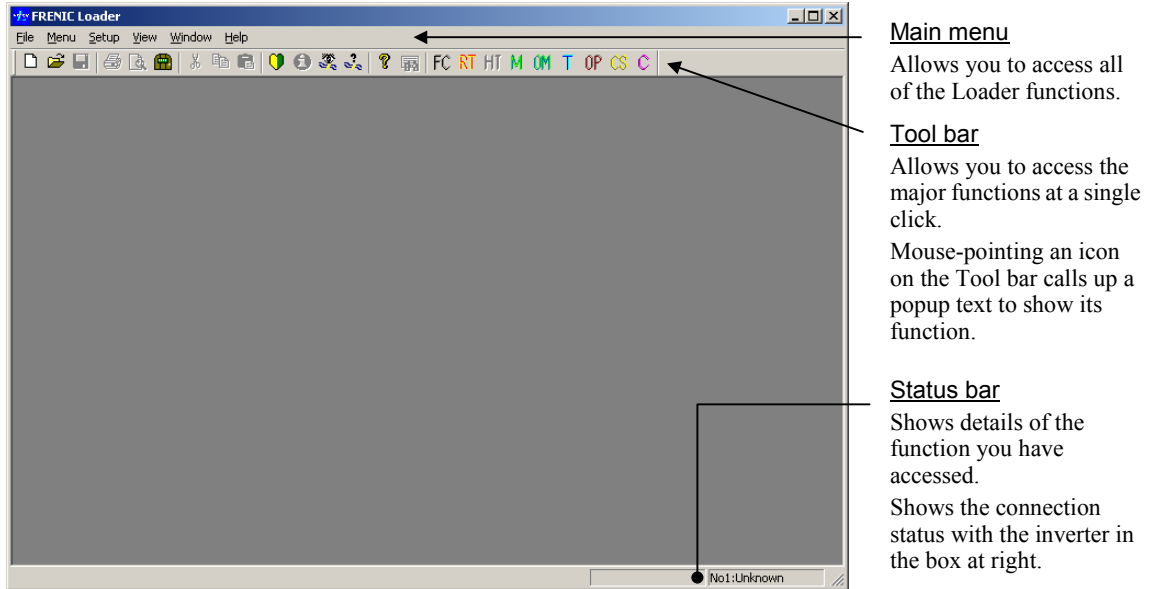

Main menu

Allows you to access all of the Loader functions.

Tool bar

Allows you to access the major functions at a single click.

Mouse-pointing an icon on the Tool bar calls up a popup text to show its function.

Status bar

Shows details of the function you have accessed.

Shows the connection status with the inverter in the box at right.

Main menu

Five menus—**F**ile, **M**enu, **V**iew, **S**etup, and **H**elp—are active even if there is nothing displayed in the window and only **W**indow will be active only if any window is opened in the top window. These menus are equipped with various sub-menus as explained in the succeeding Sections 2.2 through 2.6.

Tool bar

The tool bar is for enabling frequently used functions to be easily accessed. For example, to open a function code file stored in the PC from the toolbar just single-click the  icon as opposed to the 2 actions--**M**enu → **O**pen--if you use the main menu instead.

Status bar

Status bar shows the running status of Loader at all times. Also, to find out what an icon or menu means, simply place the mouse cursor over it and a text explaining it will popup in left part of the status bar.

When **C**on~~nect~~**ed check** is selected, the box at the right end of the status bar shows the connection status with inverters at all times. (For details about **C**on~~nect~~**ed check**, refer to Chapter 1, Section 1.4.3 "Settings on Loader.")

2.2 File

Contents of the pull-down menu of **F**ile are given below.

2.2.1 **N**ew

Creates a new file of function code data.

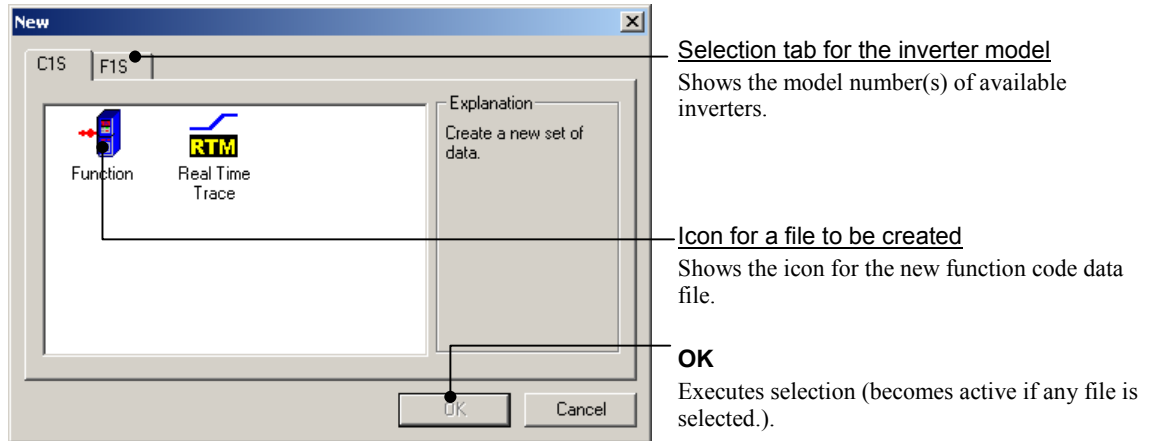

You can open a function code data file that Loader has by default in the function code edit list format. This feature allows you to edit function codes even if the communications link between the inverter and Loader.

2.2.2 **O**pen

Opens existing function code data files saved in the PC and a window to edit the file.

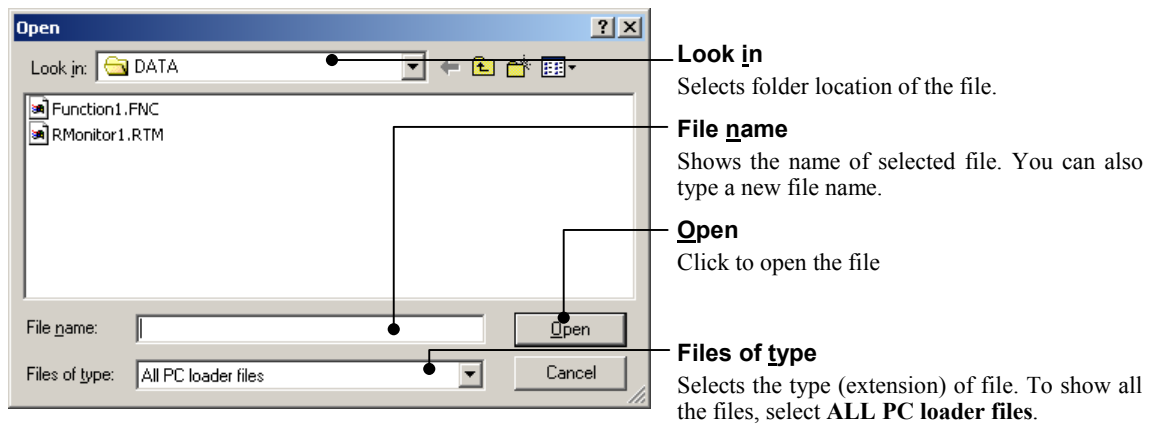

Extension of files

- *.FNC: Function code data file
- *.RTM: Real-time trace data file

2.2.3 Print Setup

Specifies the available printer, paper size, print orientation and other features needed to print the data.

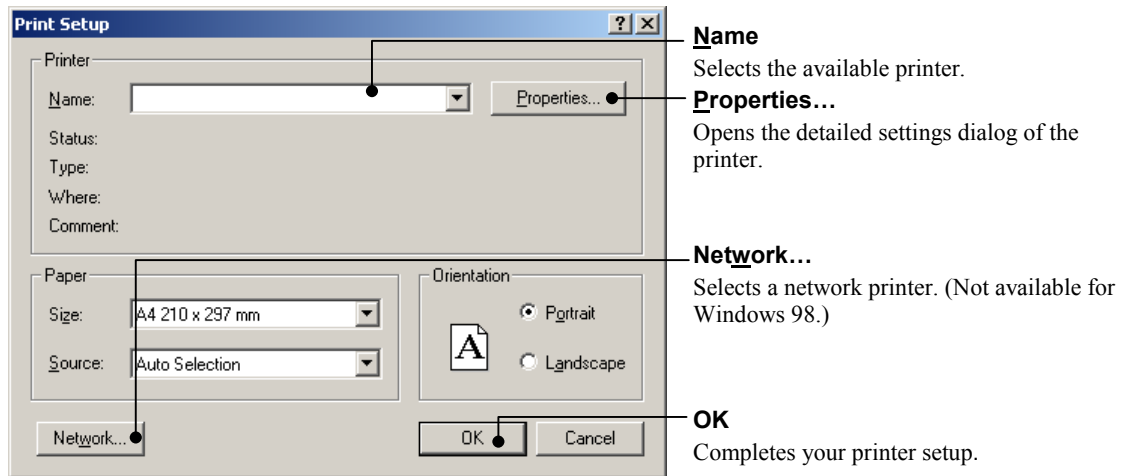

2.2.4 Exit

Exits Loader.

2.3 Menu

This menu allows you to select the functions of real time trace, multi-monitor, operation status monitor, setting function code data, test-running, quick access menu, and options. Details are given below.

2.3.1 Real-time trace—Displaying running status of an inverter in waveforms

This function allows you to simultaneously monitor the inverter running status in seamless waveform format whose sampling time is fixed at 200 ms, and tracing capability is expandable up to 4 channels of analog data, or 8 channels of digital data.

Waveform capturing capability: 15,360 samples/channel max.

Sub-screens

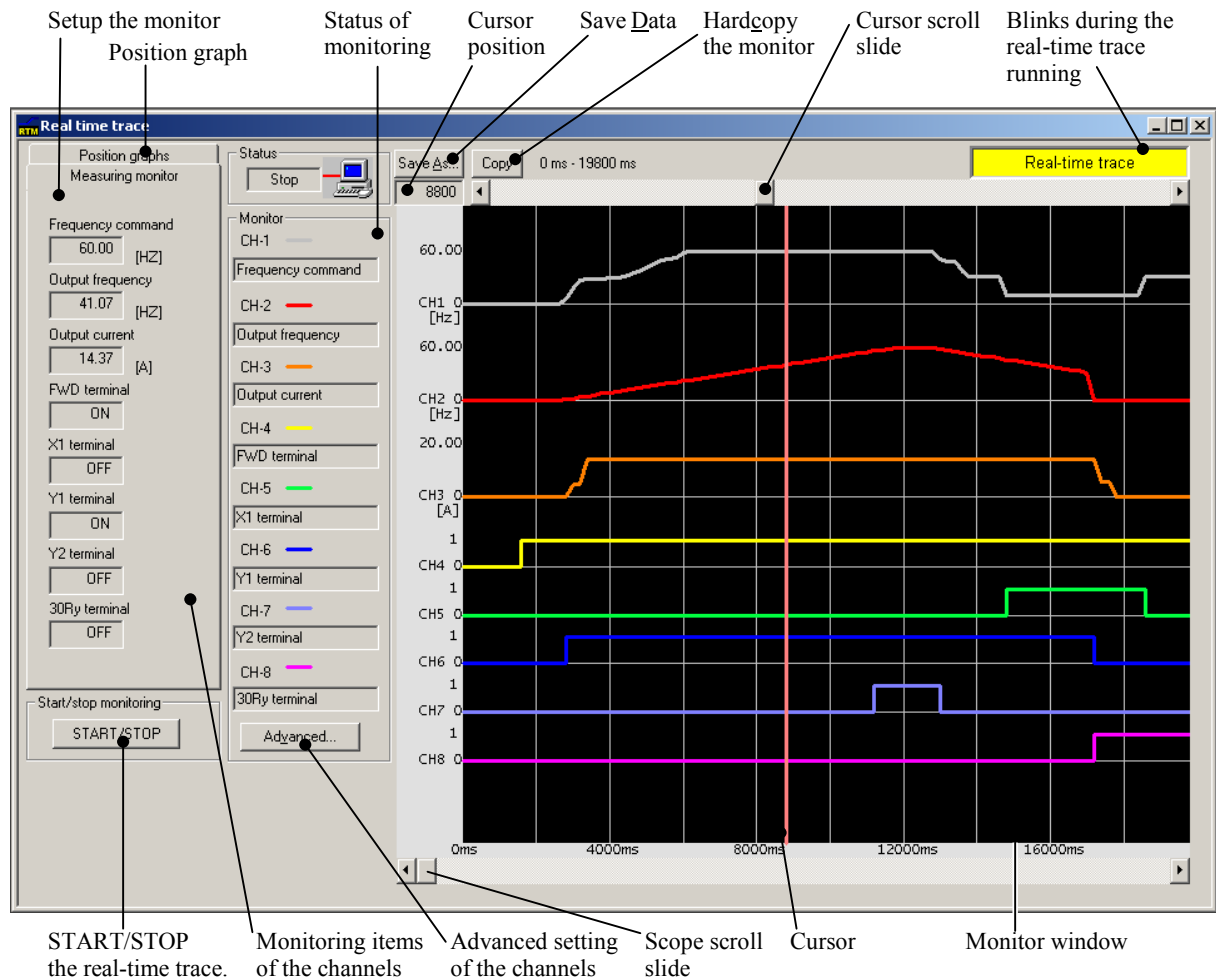

Note During the trace in progress you cannot:

- Change the RS485 station address or,
- Change the advanced waveform settings.

Resizing the real-time trace window automatically changes the monitor window size.

The real-time trace data is saved as a *.RTM file into the PC. This file opened by following **File** → **Open** on the Loader top window (see Section 2.2.2 “**Open**”) allows you to analyze behavior of the inverter at any sampling time by using the screen scroll bar and the cursor.

For doing so, move the opened real-time trace screen to the sampling time frame to be analyzed, and click a point on the trace line to place the cursor here. The cursor will move to the sampling point (time) nearest to the clicked point. Data on all the real-time trace lines will be indicated in the corresponding boxes on the Measuring monitor pane. (See 2.3.1.1 “[1] Measuring monitor.”)

You can also move the cursor by mouse-dragging of the cursor scroll slide or the cursor itself.

Note that, however, you cannot scroll the real-time trace screen and move the cursor during the real-time trace being working. At that time, the cursor is on the latest sampling point while it disappears.

2.3.1.1 Sub-windows

[1] Measuring monitor

Each box in this pane shows the measured data in numeric format at the point where the cursor is, on the waveform-traced channel.

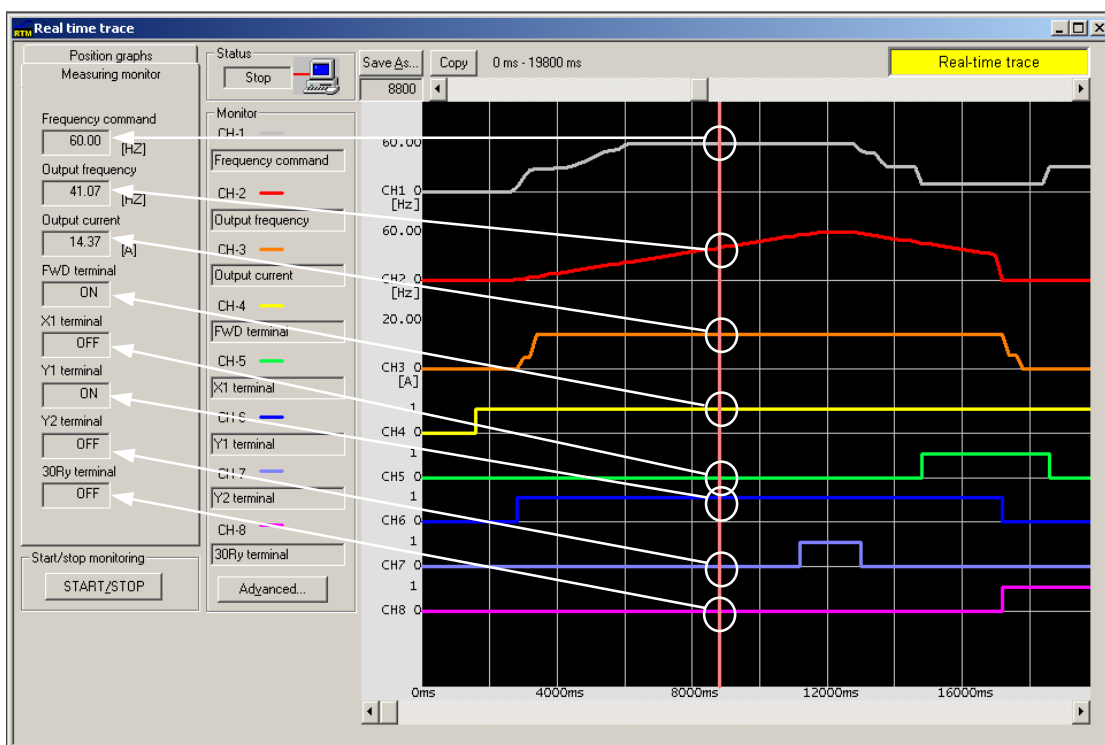

[2] Positioning graphs

Use the function in this pane to position the graph in each real-time monitor channel.

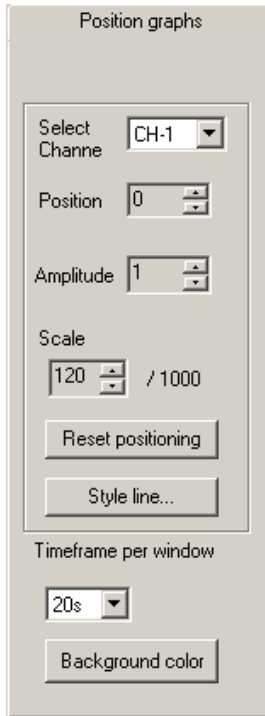

The 'Position graphs' control panel includes the following elements:

- Select Channel:** A dropdown menu currently showing 'CH-1'.
- Position:** A numeric input field with up/down arrows, currently set to '0'.
- Amplitude:** A numeric input field with up/down arrows, currently set to '1'.
- Scale:** A numeric input field with up/down arrows, currently set to '120', followed by a '/ 1000' label.
- Buttons:** 'Reset positioning' and 'Style line...'.
- Timeframe per window:** A dropdown menu currently showing '20s'.
- Background color:** A button labeled 'Background color'.

Select Channel

Select the channel, to position the graph at the place you want.

Position

Position the graph at the place you want for the selected channel.

Amplitude

Set a multiplier to magnify the waveform amplitude on the selected channel.

Scale

Specify the measuring scale for the selected monitor channel. Full scale is at 1000. This feature is only applicable to the analog channel.

Reset Graph Position

Restore the settings in Position, Amplitude and Scale for the factory defaults.

Style line...

Specify the trace line style on the selected channel.

Timeframe per window

Specify the timeframe per waveform monitor window in seconds.

Background Color

Select the background color of the waveform monitor.

2.3.1.2 Channel configuration

This feature allows you to configure the real-time monitor window for the analog and digital channels. Refer to Section 2.3.1.3 or related subsequent sections for the advanced setup for trace channels.

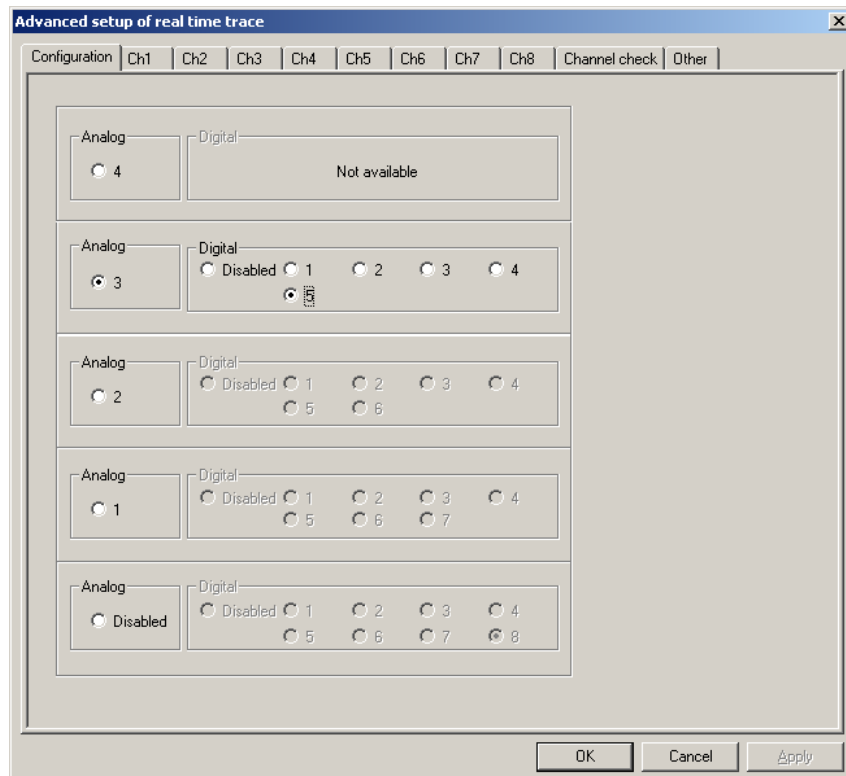

The 'Advanced setup of real time trace' dialog box features a tabbed interface with tabs for 'Configuration', 'Ch1', 'Ch2', 'Ch3', 'Ch4', 'Ch5', 'Ch6', 'Ch7', 'Ch8', 'Channel check', and 'Other'. The 'Configuration' tab is active, showing a grid of settings for each channel:

- Channel 1:** Analog: 4; Digital: Not available.
- Channel 2:** Analog: 3; Digital: Disabled, 1, 2, 3, 4.
- Channel 3:** Analog: 2; Digital: Disabled, 1, 2, 3, 4, 5, 6.
- Channel 4:** Analog: 1; Digital: Disabled, 1, 2, 3, 4, 5, 6, 7.
- Channel 5:** Analog: Disabled; Digital: Disabled, 1, 2, 3, 4, 5, 6, 7, 8.

Buttons for 'OK', 'Cancel', and 'Apply' are located at the bottom right.

2.3.1.3 Real-time trace—Advanced setup of analog channels

This window is for advanced setup of the analog monitor channels, Channel 1 to Channel 4. Details follow.

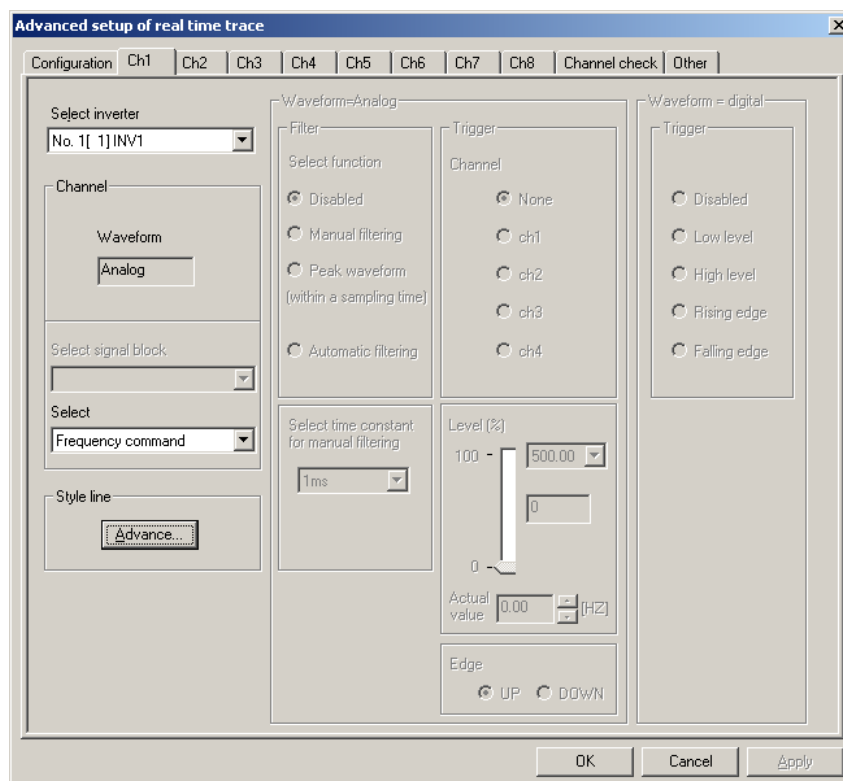

Select signal block

Listed below shows information that can be real-time traced for the FRENIC-Mini/Eco series of inverters.

Inverter information	For FRENIC-Mini inverters	For FRENIC-Eco inverters
Frequency command	Y	Y
Output frequency (before slip compensation)	Y	Y
Output frequency (after slip compensation)	Y	N
Output current	Y	Y
Output voltage	Y	Y
Motor speed	N	Y
Load shaft speed	Y	Y
Line speed	Y	N
PID process command	Y	Y
PID feedback value	Y	Y
PID output value	N	Y
Output torque	N	Y
Input power	Y	Y
Motor output power	N	Y
Load factor	N	Y
DC link circuit voltage	Y	Y
Inverter internal temperature	N	Y
Heat sink temperature	Y	Y

Y: Applicable, N: Not applicable

Styling trace lines

The dialogs below allow you to style each trace line on the selected channel in color, dash style and line style.

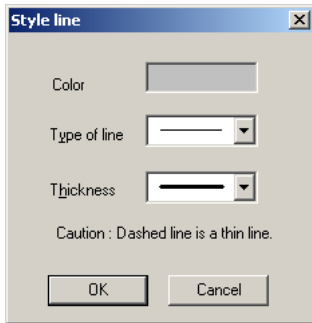

To call up the line color dialog, click the **Color** box.
To style the line in Dash or Line, click the ▼ button in the **Type of line** or **Thickness** combo-box respectively.



Color a trace line.

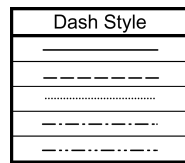

Style a trace line.

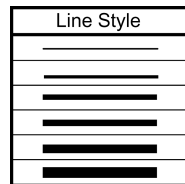

Style a trace line.

2.3.1.4 Real-time trace—Advanced setup of digital channels

This window is for advanced setup of the digital monitor channels, Channel 1 to Channel 8. Details follow.

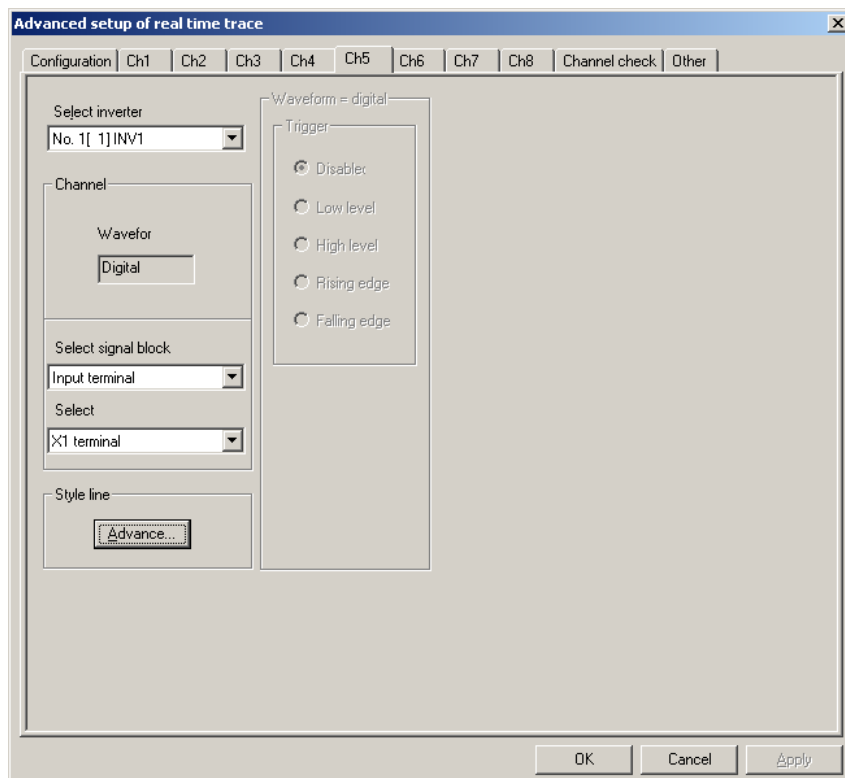

Select signal block—digital control signal input terminals

Listed below shows information that can be real-time traced for the FRENIC-Mini/Eco series of inverters.

Signal input terminals	For FRENIC-Mini	For FRENIC-Eco
X1	Y	Y
X2	Y	Y
X3	Y	Y
X4	N	Y
X5	N	Y
FWD	Y	Y
REV	Y	Y

Y: Applicable, N: Not applicable

Select signal block—digital signal output terminals

Listed below shows information that can be real-time traced for the FRENIC-Mini/Eco series of inverters.

Signal output terminals	For FRENIC-Mini	For FRENIC-Eco
Y1	Y	Y
Y2	N	Y
Y3	N	Y
Y5 (for AX and 52-1)	N	Y
Y5A/C Relay	N	Y
30A/B/C Relay	Y	Y

Y: Applicable, N: Not applicable

Styling trace lines

You can style the digital signal trace line for the selected channel as well as that for the analog ones. For details refer to Section 2.3.1.3 "Real-time trace—Advanced settings for analog channels."

2.3.1.5 Real-time trace—Advanced setup of reconfirming the channel setup

The window below allows you to reconfirm your real-time trace channel setup. To make your setting effective, press **OK**, to cancel it, press **Cancel**.

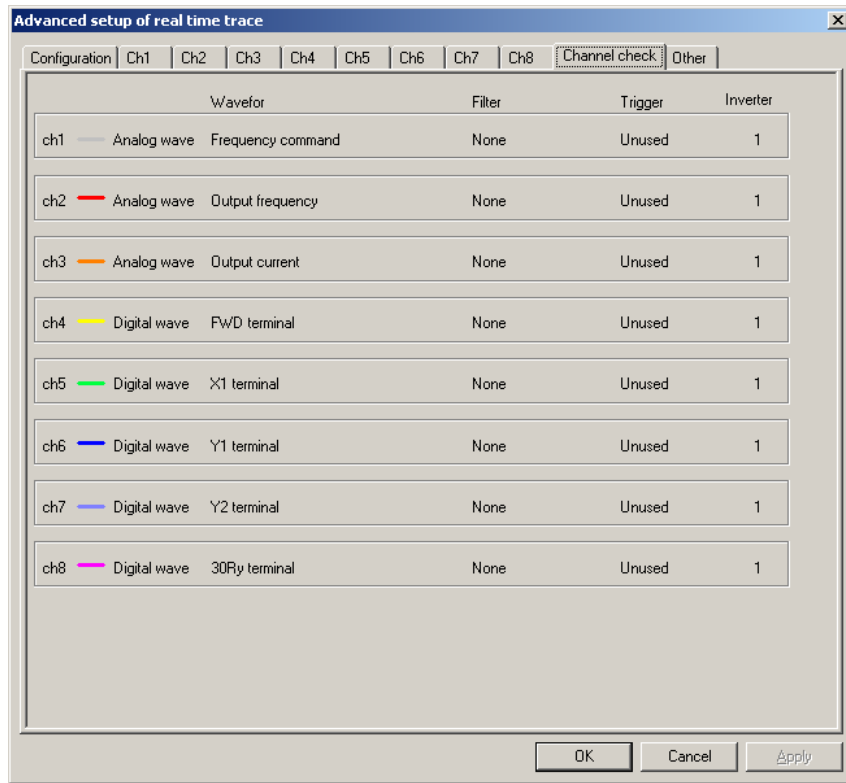

2.3.1.6 Real-time trace—Other advanced settings

The window below allows you to customize your real-time trace waveform configuration in details.

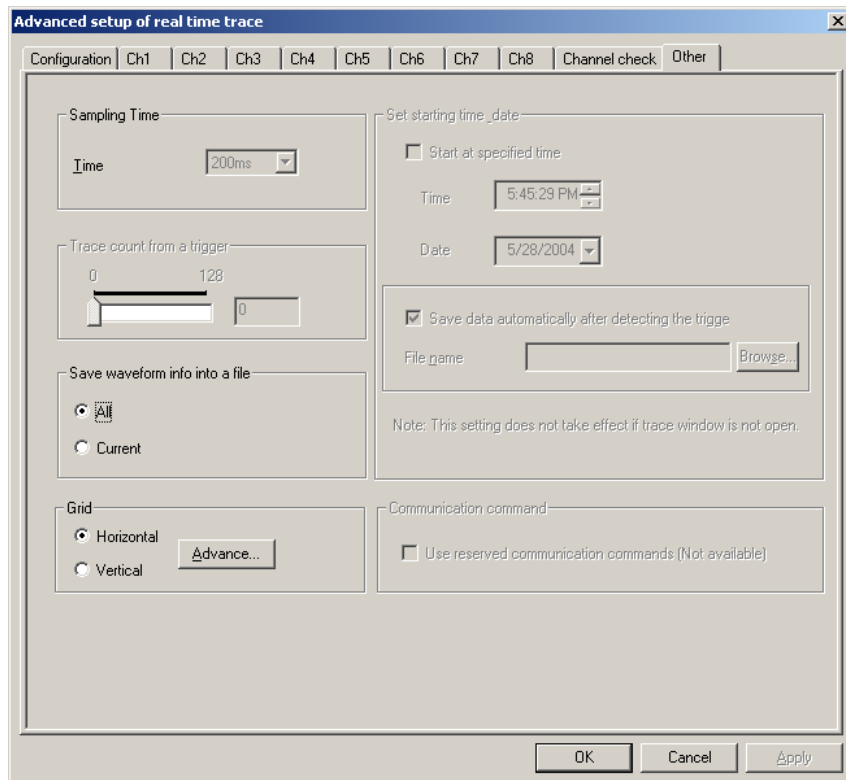

2.3.2 Multi-monitor

This allows you to monitor the running status of the inverter(s). Monitoring all inverters on the network at glance in list format is also available.

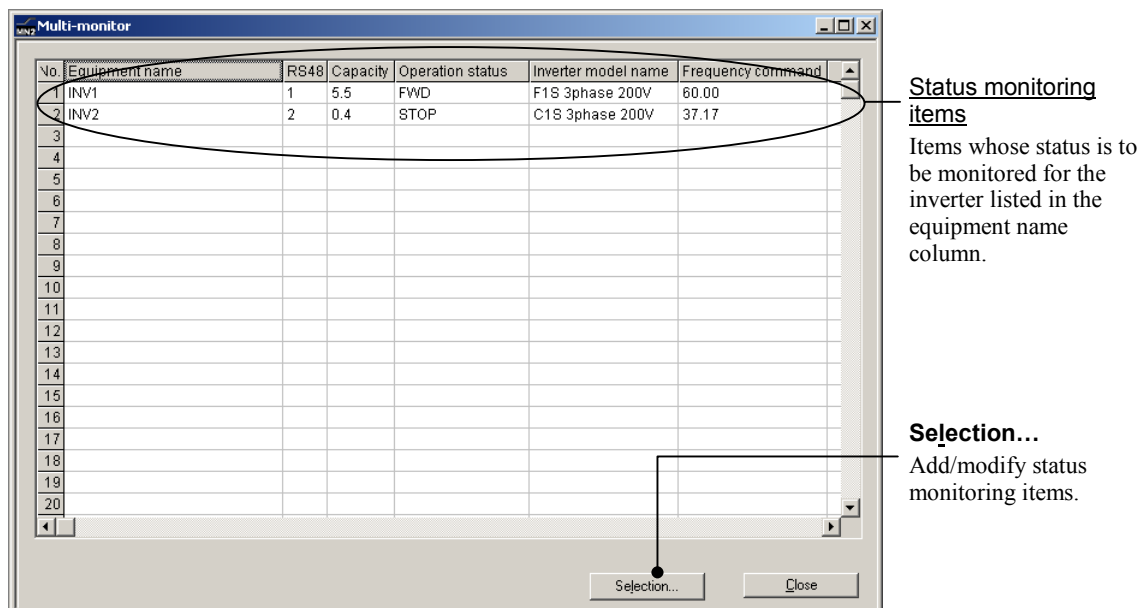

No.	Equipment name	RS48	Capacity	Operation status	Inverter model name	Frequency command
1	INV1	1	5.5	FWD	F1S 3phase 200V	60.00
2	INV2	2	0.4	STOP	C1S 3phase 200V	37.17
3						
4						
5						
6						
7						
8						
9						
10						
11						
12						
13						
14						
15						
16						
17						
18						
19						
20						

Status monitoring items
Items whose status is to be monitored for the inverter listed in the equipment name column.

Selection...
Add/modify status monitoring items.

[1] Adding/deleting the listed items

To add/delete the listed items on this table, open the dialog shown below by clicking **Selection...**

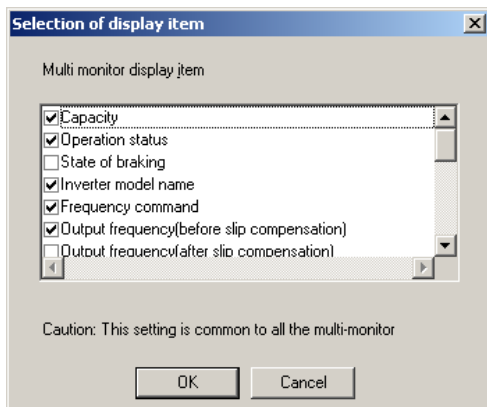

To add an item to be listed in the table, place a ✓ mark in the box to the left of the item in the list.

Click the box again to remove the ✓ mark.

If your selection is complete, click **OK**.

Note that any items without a ✓ mark will not be listed in the table.

Inverter information displayable is listed below.

Inverter information	For FRENIC-Mini inverters	For FRENIC-Eco inverters
Equipment name	Y	Y
RS485 address	Y	Y
Capacity	Y	Y
Operation status	Y	Y
State of breaking	N	Y
Inverter model name	Y	Y
Frequency command	Y	Y
Output frequency (before slip compensation)	Y	Y
Output frequency (after slip compensation)	Y	N
Output current	Y	Y
Output voltage	Y	Y
Motor speed	N	Y
Load shaft speed	Y	Y
Line speed	Y	N
PID process command	Y	Y
PID feedback value	Y	Y
PID output value	Y	Y
Output torque	N	Y
Torque current	N	N
Torque current reference	N	N
DC link circuit voltage	Y	Y
Input power	Y	Y

Y: Applicable, N: Not applicable

2.3.3 Operation monitor

This feature allows you to monitor information of the inverters in running, in the list format.

2.3.3.1 I/O monitor—Monitor for control input/output signal status of the inverter

This feature monitors the ON/OFF status of the programmable input terminals and the transistor and mechanical relay contact outputs of the selected inverter.

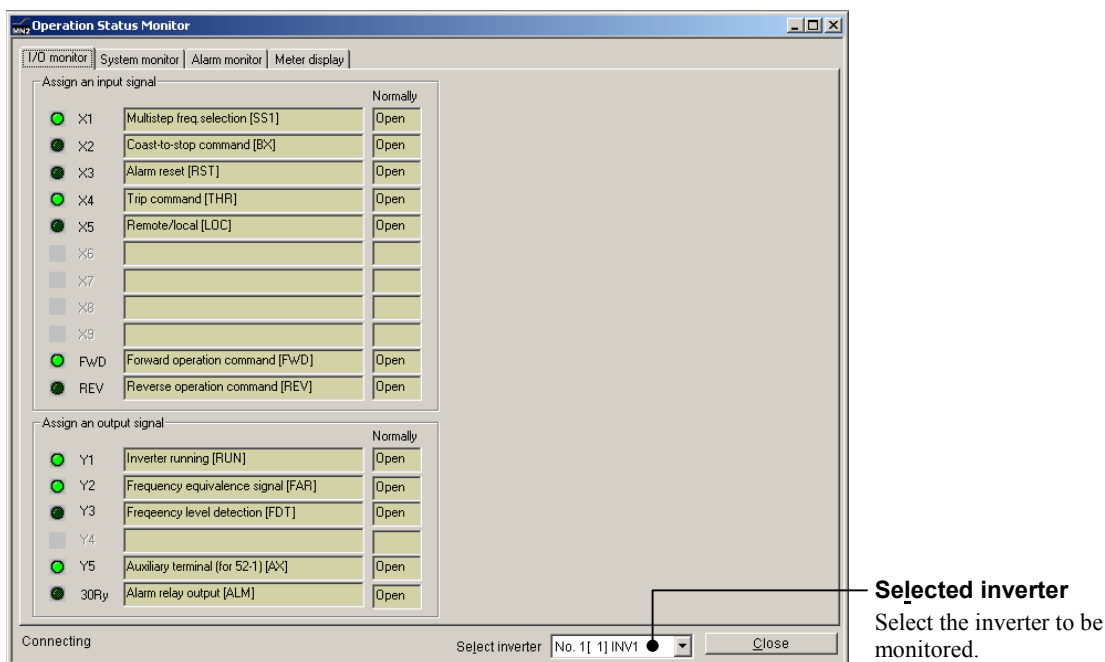

2.3.3.2 System monitor

This allows you to check the inverter ROM version, model name, currently setup information, and maintenance information of the selected inverter.

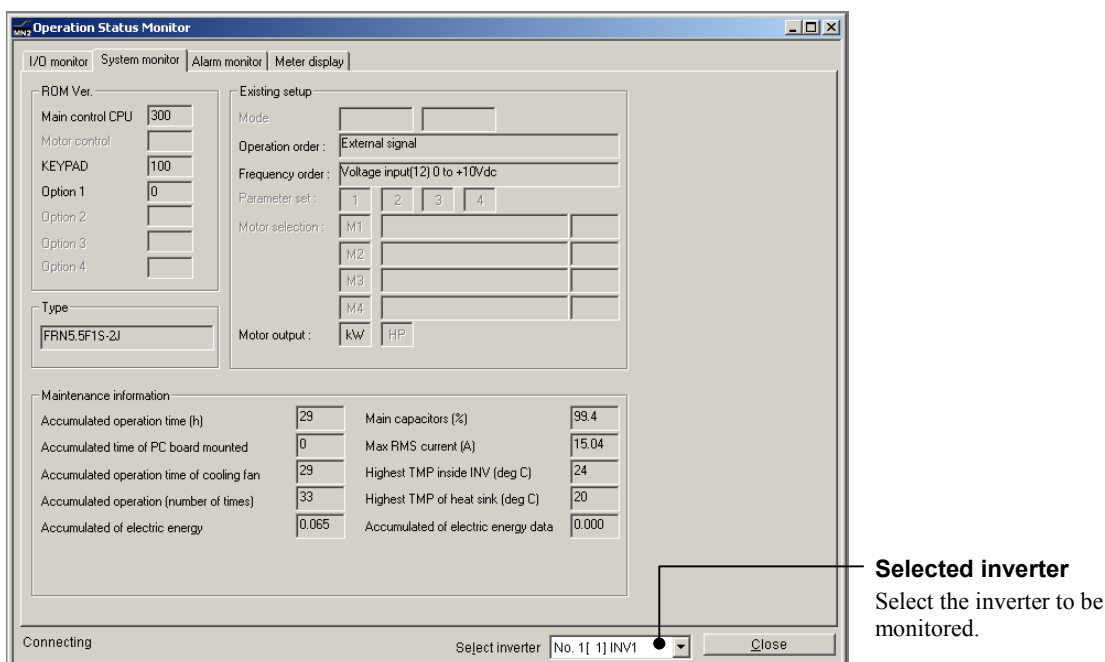

2.3.3.3 Alarm monitor

The alarm monitor shows the alarm status of the selected inverter. In this window you can check the details of the alarm currently occurs and related information.

Select the alarm record to be shown

Select the alarm record for the latest 4 alarms of the inverter in this combo-box.

Alarm reset...

Resets the alarm currently occurs.

ALM history initialization...

Initializes the alarm history for the selected inverter.

Print...

Quick-prints data related to the alarm.

Save as...

Saves the alarm information in CSV format.

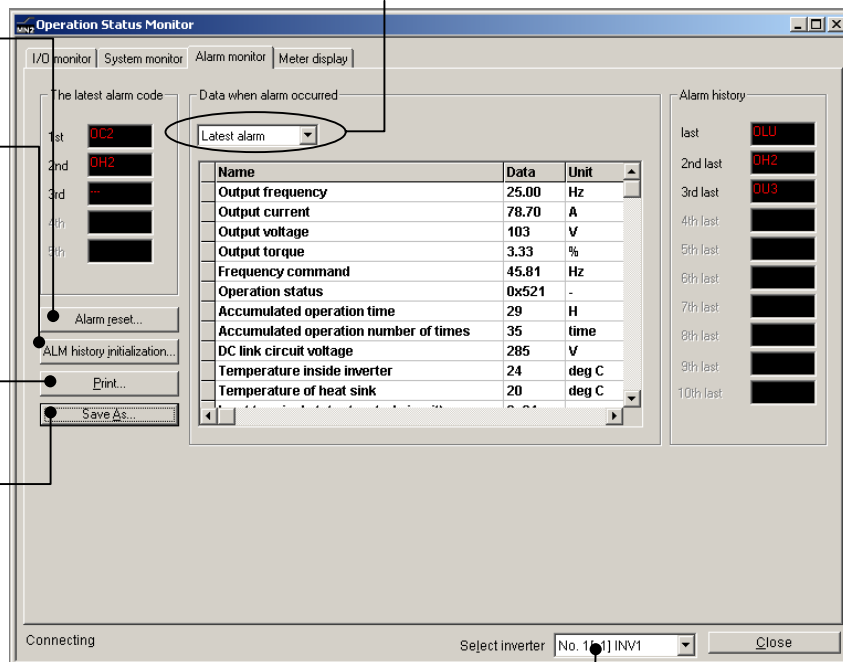

Selected inverter

Select the inverter to be monitored.

2.3.3.4 Meter display

This display shows data such as output frequency of the inverter on the illustrated analog meters. The hollow pointers indicate the peak values if the Peak-hold is checked.

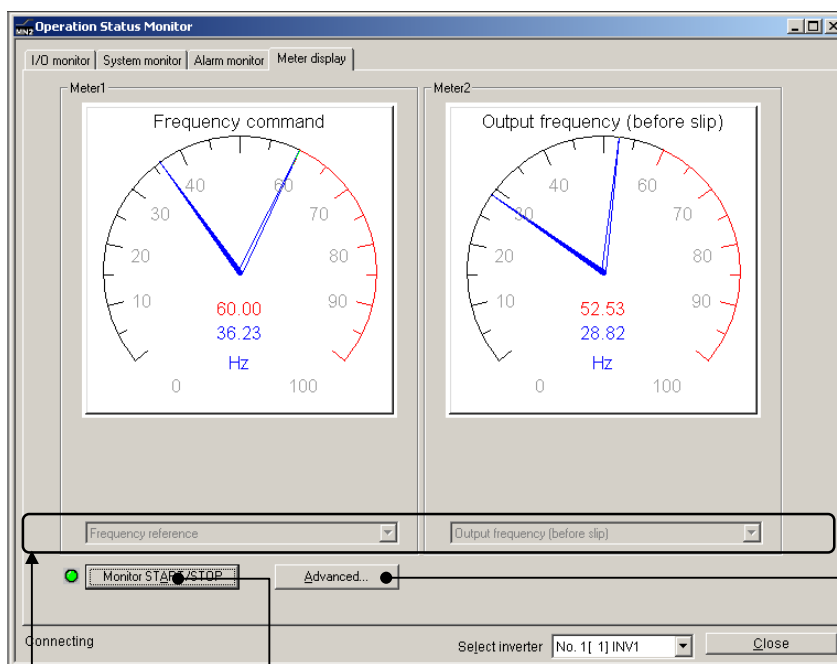

Select data to be shown
The combo-boxes to select the data to be shown on the analog meters.

Monitor START/STOP
Starts or stops monitoring the inverters.

Advanced...
Sets details of the data format to be shown in the meters for maximum, minimum, decimal points and etc

[1] How to setup information to be monitored

Click the ▼ button of the combo-box at the bottom of meter panes, select an item listed there. Information you can display on the analog meter is listed below.

Inverter information	For FRENIC-Mini	For FRENIC-Eco
Frequency command	Y	Y
Frequency (before slip compensation)	Y	Y
Frequency (after slip compensation)	Y	N
Output current	Y	Y
Output voltage	Y	Y
Motor speed	N	Y
Load shaft speed	Y	Y
Line speed	Y	N
PID process command	Y	Y
PID feedback value	Y	Y
PID output value	N	Y
Output torque	N	Y
Input power	Y	Y
Motor output power	N	Y
Load factor	N	Y
DC link circuit voltage	Y	Y
Inverter internal temperature	N	Y
Heat sink temperature	Y	Y
Input terminal voltage [12]	Y	Y
Input terminal current [C1]	Y	Y
Input terminal voltage [V2]	N	Y
Analog input for displaying	N	Y

Y: Applicable, N: Not applicable

[2] How to setup the advanced settings for analog meters

Click **A**dvanced in the analog meter pane to call up the dialog below.

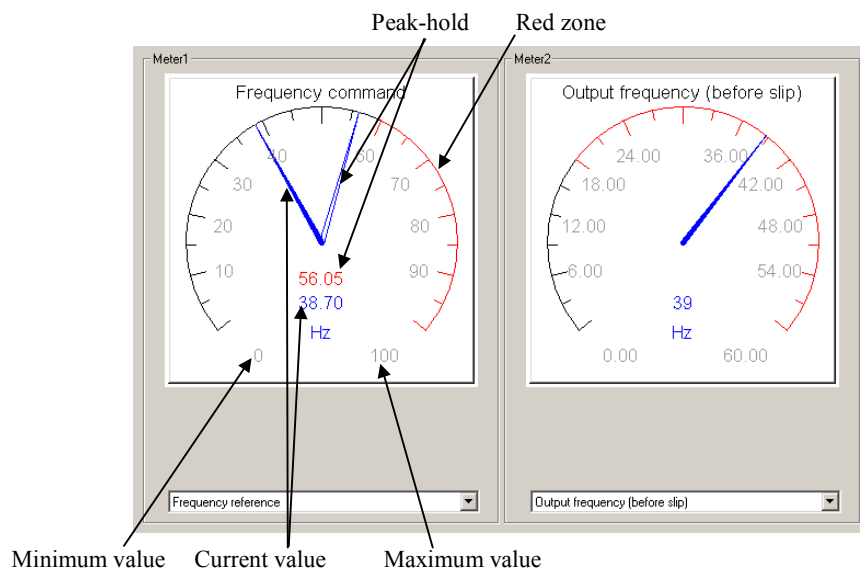
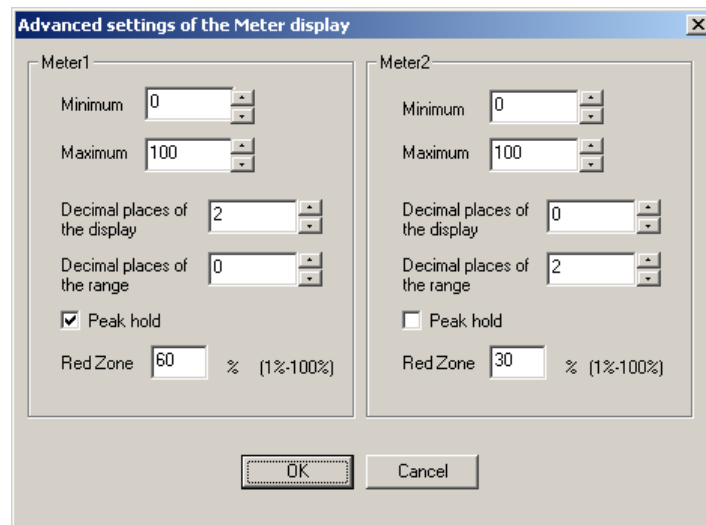

- Minimum value: Specify the minimum value at the low end point of the meter scale.
- Maximum value: Specify the maximum value at the high end point of the meter scale.
- Decimal in numeric: Specify No. of decimal places for the current and peak-hold display. (Digital display precision)
- Meter scale index: Specify No. of decimal places for the analog meter index.
- Peak-hold: Enable/disable the peak-hold that makes the meter hold the measured peak value.
- Red zone: Specify the red colored scale ratio to the meter full scale.

2.3.4 Setting function code data

Select one from **Function code edit**, **Comparison** and **File information**. Within these facilities, you can select any of the following 3 items.

(1) Creating a new function code file, (2) Function code file saved in the PC or (3) Function code data set in the inverter.

When your selection is complete, click **OK**. The Function code edit window shown in the succeeding section will be opened.

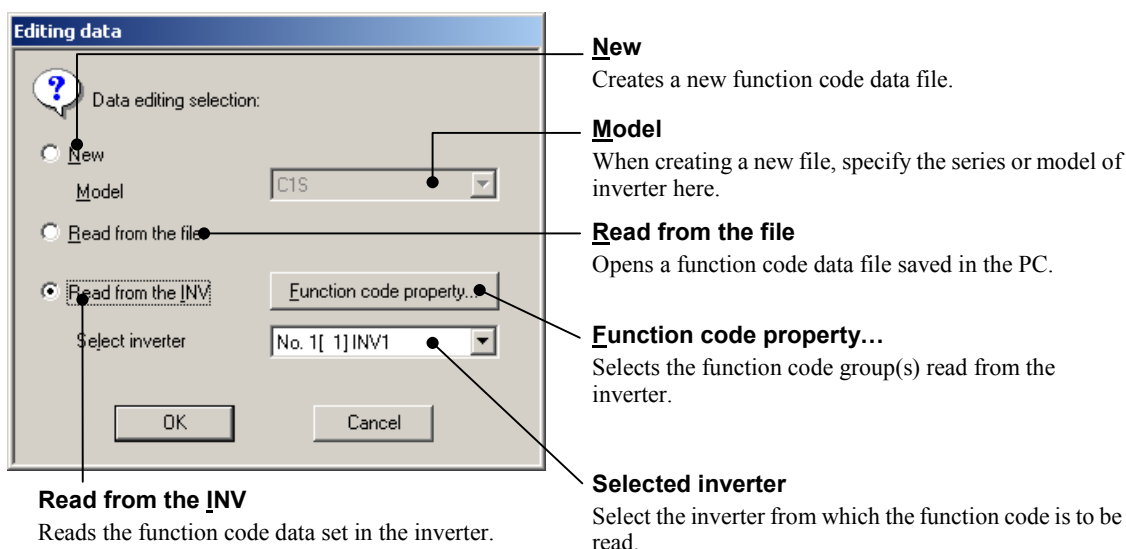

When you have selected **New**, you can open the function code data file that is stored in Loader by default in the function code edit format. (See Section 2.3.4.1) This feature allows you to edit the function code data even if the communications link between an inverter and Loader is not established.

2.3.4.1 Function code edit

In this window you can list and edit the function codes while showing their data range and other attributes allowable to be set. Descriptions for button and combo-box functions in the window are given below.

Code group: Lists the function codes by group.

Changed from Factory setting: Lists the codes whose default data settings have been changed. (Except communications related codes)

Edited function codes (in red): Lists edited function codes not yet written into an inverter.

User definition: Lists the codes selected by the user to list.

Comparison result: Lists only comparison results with the function codes stored in the inverter or saved in Loader.

Search result: Lists only results searched by the keyword in conjunction with the function code name.

Setting data

Select function code data listed in the dropdown menu.

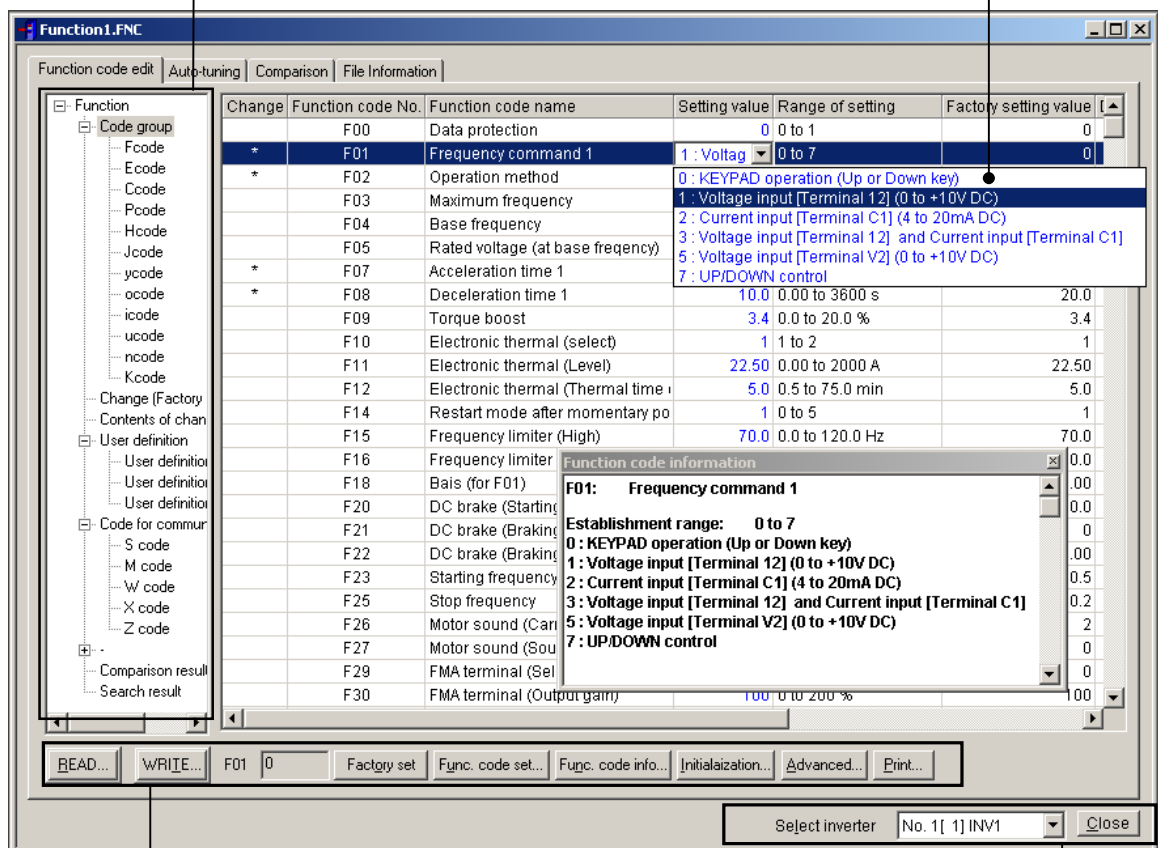

Read: Reread the data from the inverter selected at **Select inverter**.

Write: Writes data saved in Loader into the inverter selected at **Select inverter**.

Factory defaults: Reset the selected function code to the factory default.

Function code data: Show data set in the selected function code in the window.

Function code information...: Show information of the selected function code in the window.

Initialization: Initialize the data set in the inverter selected at **Select inverter**.

Advanced: Calls up the Advanced setting dialog for **Display items...**, **Function code attribute**, and **Print setting...**

Print setting...: Select the page setup or easy-print format.

Select inverter: Select the inverter to which the data is to be sent.

Close: Close the Function code edit window.

[1] Read function code data stored in the inverter

How to read out the function code from an inverter first time after Loader started

Click the **Func. Code** icon on **Quick access Menu** to call up the **Editing data** dialog below. Select **Read from the Inverter** and click **OK** in the dialog.

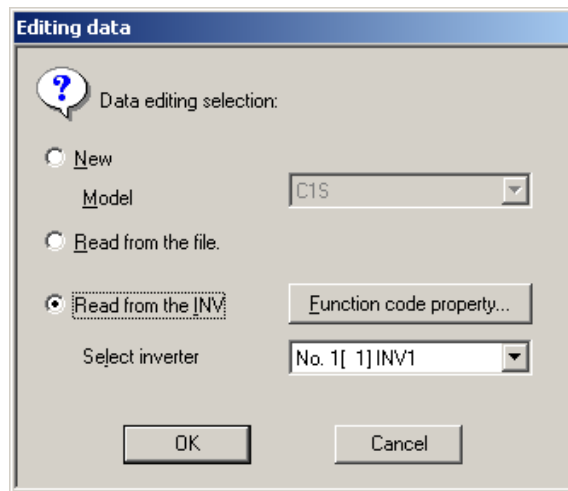

How to update the function code data already read from the inverter

Clicking the **Read...** button on the function code edit list window calls up the dialog below. Clicking **OK** starts rereading the function code data from the inverter.

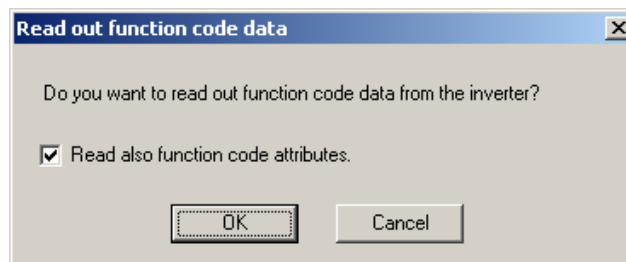

How to read out the function code with its attribute

If you place the ✓ mark in the head-box of **Read also function code attributes** in the dialog above, Loader reads the function code data altogether its default setting, minimum value, maximum value and other attributes from the inverter.

To specify what is the function code group you want to read the function code attributes, first call up the **Advanced...** dialog shown below by clicking **A**dvanced... at the bottom of the function code edit list window. Then click **F**unc. code attributes... in the dialog to open the **Function code property** dialog below next.

Place the ✓ mark(s) in the head-box(es) of the function code(s) you want to read the code(s) with its attribute(s). To do so for all function codes, place the ✓ mark in the head-box of **A**ll function codes.

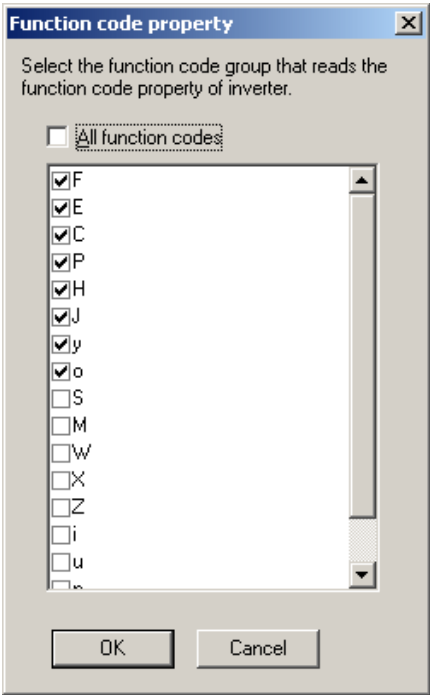
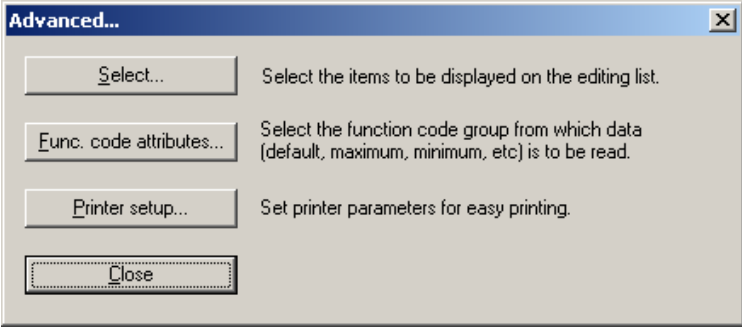

[2] How to change the function code data

To change the function code data you need to manipulate it in one of two different ways depending on the property of the code, as shown below.

- (1) For function codes whose data is a numeric value such as frequency, time, or voltage, double-click the Range of setting column of the listed function code. The Range of setting dialog will appear. Enter a numeric value directly or select it by clicking the list box handles in the dialog.

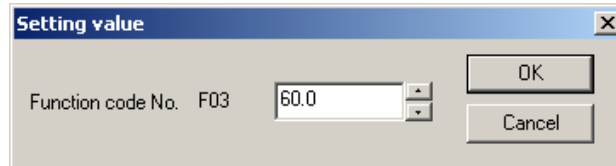

- (2) For function codes whose data specifies the inverter function -- for example, F00 (1: Protect data)/01 (1: Frequency setting by voltage input)/02 (0: Run/stop by keypad), click the Setting value column of the listed function code. A combo-box will appear. Click ▼ to show the data you can select in the dropdown menu.

Setting value	Range of setting	Factory setting value	Data c
0	0 to 1	0	
1 : Voltag	0 to 7	0	
0 : KEYPAD operation (Up or Down key) 1 : Voltage input [Terminal 12] (0 to +10V DC) 2 : Current input [Terminal C1] (4 to 20mA DC) 3 : Voltage input [Terminal 12] and Current input [Terminal C1] 5 : Voltage input [Terminal V2] (0 to +10V DC) 7 : UP/DOWN control			

- (3) In the **Function code edit** window, clicking the **Func. Code info.** button, or double-clicking the function code name on the function code row calls up a popup text below, which gives you more detail information of the function code. Furthermore, just clicking another row switches contents of the text for the new function code while this text is shown.

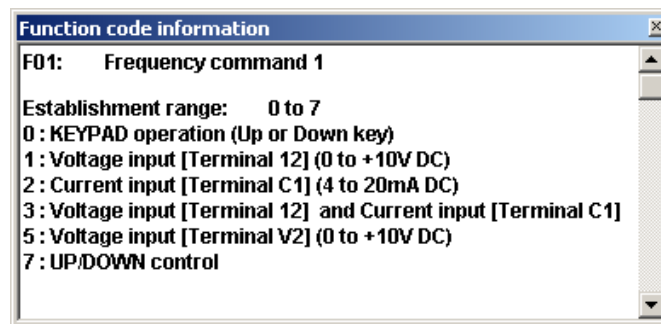

- Note** Selected data that has not been written into the inverter is shown in blue on the list.
- Note** If the selected data differs from the factory default, it will be marked with an asterisk (*) in the first column of the list.

[3] Writing the function code data into the inverter from Loader

To write function code data in to the inverter, click **Write** at the bottom left of the **Function code edit list** window.

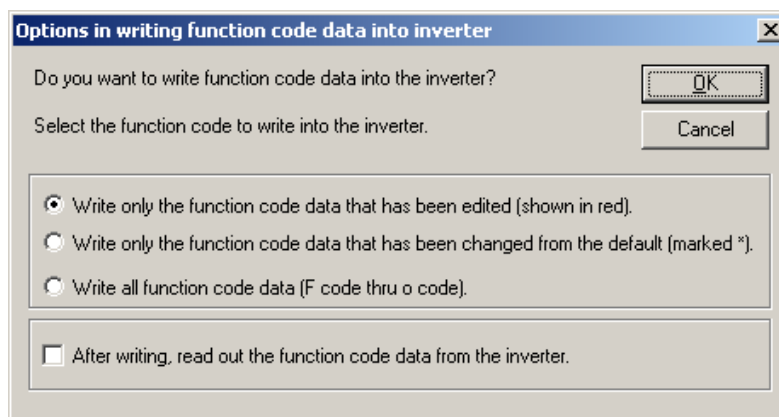

[4] Writing function codes in to inverters whose rated power inputs or capacities are different each other...



It is impossible for the inverters whose rated power inputs are different each other to write the identical data of function code with the data-copy attribute of "1." Further, also impossible for the inverters whose rated power inputs or capacities are different each other to write the identical data of function code with the data-copy attribute is "2."

For function codes with the data-copy attribute is "0" the identical data set is written into any inverters unconditionally.

Data copy attributes

Numeric in Data Copy column	Description
0	Writes the copied data into the inverter unconditionally.
1	Does not write the data into the inverter whose rated input differs from original one's.
2	Does not write the data into the inverter whose rated input or rated capacity differs from original one's.

Example:

Change	Function code No.	Function code name	Setting value	Data Copy
	F00	Data protection	0	0
*	F01	Frequency command 1	1	0
*	F02	Operation method	1	0
	F03	Maximum frequency	60.0	0
	F04	Base frequency	50.0	0
	F05	Rated voltage (at base frequency)	200	1
*	F07	Acceleration time 1	10.0	0
*	F08	Deceleration time 1	10.0	0
	F09	Torque boost	3.4	2
	F10	Electronic thermal (select)	1	0
	F11	Electronic thermal (Level)	22.50	2
	F12	Electronic thermal (Thermal time constant)	5.0	0

[5] Saving function code data in the PC

To save the function code data listed on the Loader window or dialog in the PC's file, click **S**ave, or **S**ave **A**s... in **F**ile.

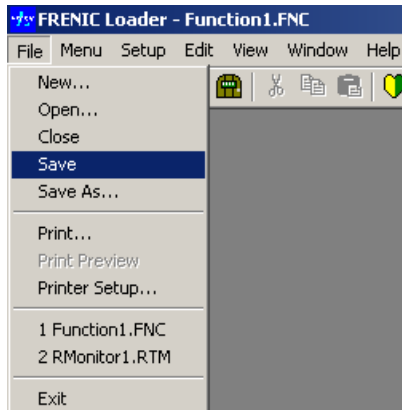

When you are attempting to save data first time, if you click **S**ave, Loader calls up **S**ave **A**s... dialog shown below.

Select a folder at **S**ave **I**n: and type a filename at **F**ile **n**ame:, then click the **S**ave button.

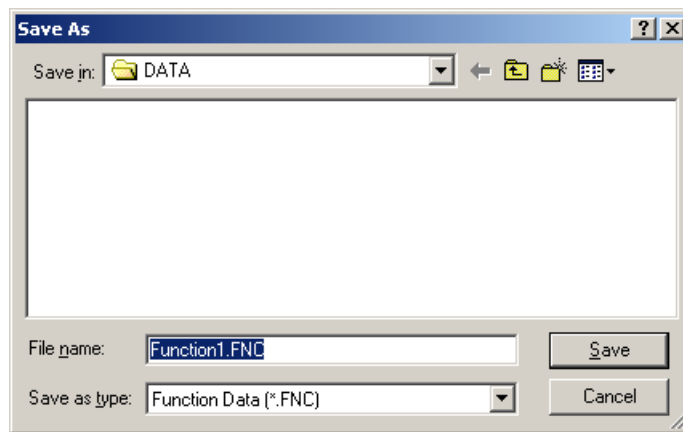

[6] Initializing the function code data stored in an inverter

To initialize the function code data setup in the inverter currently selected, click the **I**nitialization... button on the Function code edit window. A dialog below will popup. Click ▼ in the Function code combo-box and select either one, and click **O**K.

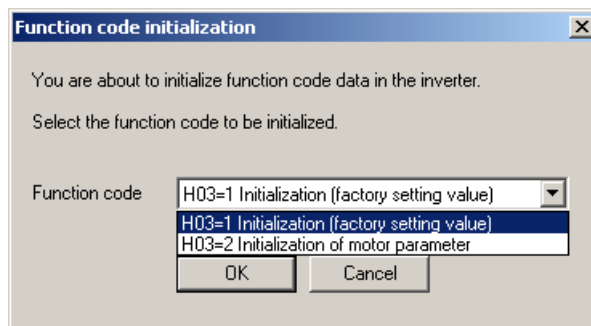

Note that:

- (1) "H03 = 1 Initialization [factory setting value]" initializes F, E, C, P, H, J, y, and o codes by the factory defaults.
- (2) "H03 = 2 Initialization of motor parameter" initializes P codes except P02 (: Motor capacity) and P99 (: Select motor) by the factory defaults.

[7] Printing the function code data list

Click **Function** or **Code group** in the hierarchy tree on the left pane of the Function code edit tab to show function code/code group of F, E, C, P, H, J, y, o, S, M, W, X, or Z.

To print a function code list, click **Print...** in **File** on the main menu of Loader top window or click the **Print** button at the bottom of the Function code edit window. The Print dialog shown below will appear.

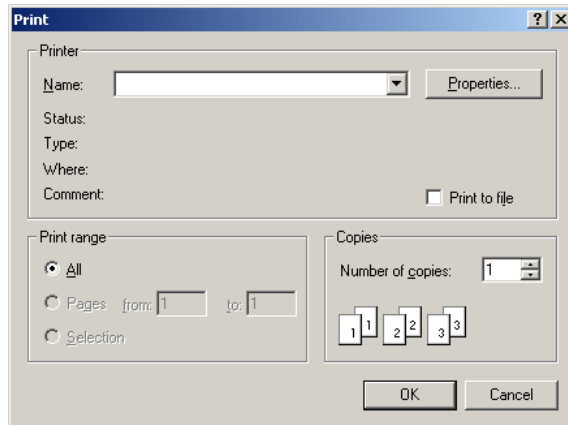

Specify the printer, print range and number of copies, and then click **OK**.

To check or reconfigure the printer shown in the **Name** combo-box, click **Properties...**

How to quick-print

On the items listed in the Function code edit window you can quick-print only 3 columns: the ID number (F NO.), name, and currently set data of the function codes. To do so, click **Print setting...** which is located at the bottom of Function code edit window. The Print setting dialog will appear. Place the mark at **Print in simplified way** and click **OK**. Note that this action only specifies a print format and does not start printing.

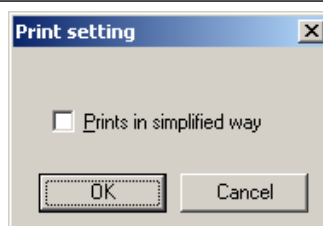
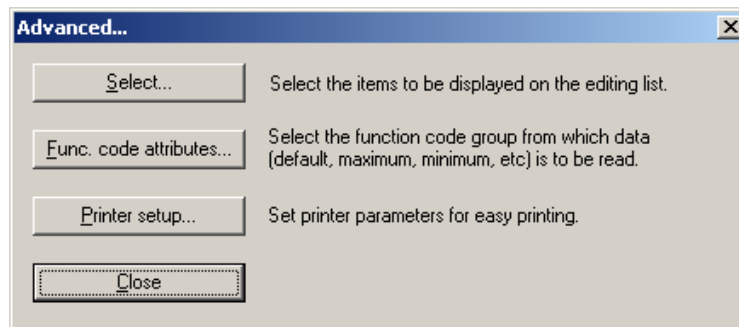

Print preview

To preview what you are going to print on your desktop before you actually print it, click **Print preview** in **File** on the Loader main menu.

2.3.4.2 Auto-tuning motor parameters

This feature automatically measures parameters of the motor, and saves them as data of the function codes P06, P07 and P08. This is very similar to the function code P04 (: Motor auto-tuning.)

Specifying the auto-tuning

Select the motor parameter to be auto-tuned.

Processing status

Shows current status of auto-tuning in progress.

Motor parameters
Displays the motor parameters stored in the target inverter.

Auto-tuning control
Start/stop the auto-tuning.

Output frequency
Shows current output frequency of the inverter.

Rotational direction
Select rotational direction of the motor.

Selected inverter
Select the inverter to auto-tune the motor.

To specify auto-tuning you can select:

- 0: Disabled
- 1: Tune %R1 and %X while the motor stops.
- 2: Tune %R1 and %X while the motor stops and excitation reactance while the motor runs.

To determine rotational direction of the motor you can select:

- Follow the local command: Follows the terminal command inputs (FWD/REV terminals.) This is effective only if setting of the function code F02 is "1: External command."
- FWD: Run the motor forward. (This is effective only if Loader is enabled to run the inverter.)
- REV: Run the motor reverse. (This is effective only if Loader is enabled to run the inverter.)

Note Selecting FWD or REV forces you to choose "2" or "3" for the frequency/run command in Test-running. (See Section 2.3.5 "Test-running.")

2.3.4.3 Comparing the function codes

To compare the function code data currently being edited with those set in the inverter, click the Comparison tab in the Function code edit window.

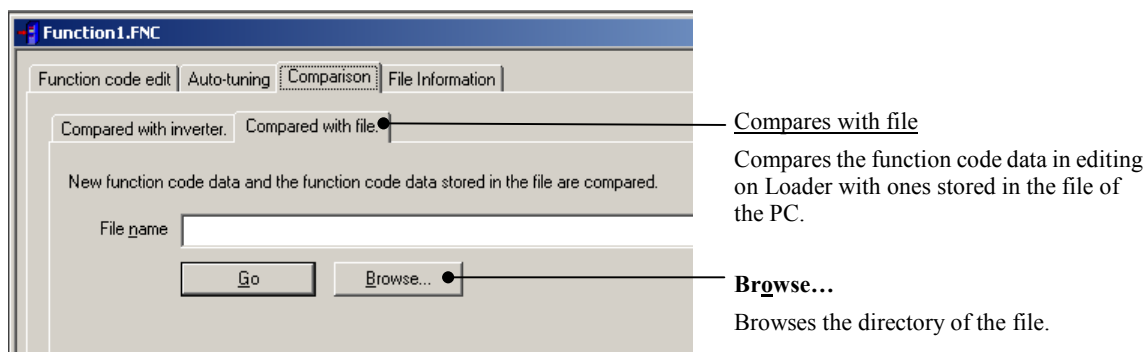
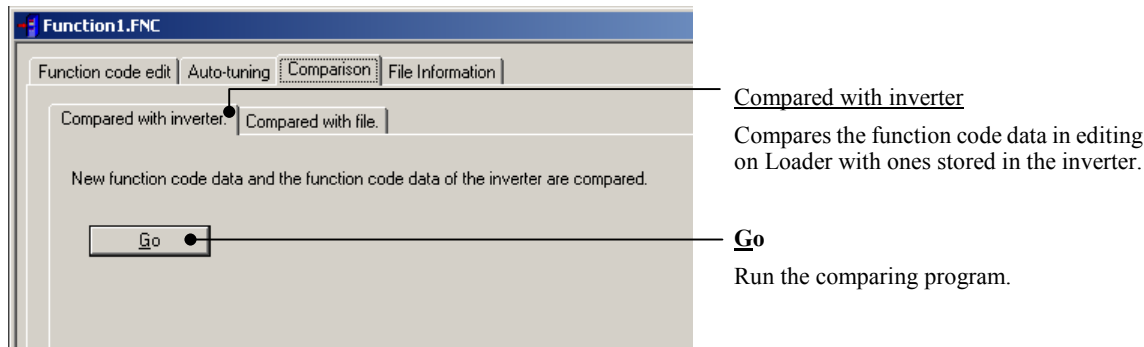

Before stating comparison, click ▼ of the **Select inverter** combo-box at the bottom of the Function code edit window to show all inverters available in the dropdown menu, and select one.

Loader lists the comparison result, which includes only those function code data that differ each other, in the Comparison window shown below.

Comparison

Comparison was completed. There is a difference in 118 data entries.
Data during editing : Function1
Applicable comparative data : 5.5F1S-2J

Function name	Data during editi...	Applicable
F01: Frequency command 1	0	1
F02: Operation method	2	1
F07: Acceleration time 1	20.0	10.0
F08: Deceleration time 1	20.0	10.0
E01: X1 terminal function (Select)	6	0
C05: Multistep frequency setting 1	0.00	10.00
P03: Motor (Rated current)	22.50	22.51
H42: Main circuit capacitor lifetime	0	61184
H43: Cooling fan accumulated operatio...	0	36
H47: Main circuit capacitor initial value	0	61440
H48: Capacitor on PC board accumul...	0	1

Re-compare Close

How to edit the function code data listed on the Comparison window

Click the Comparison result row on the left pane of the Function code edit window to show the function code listed on the Comparison window. To reedit them follow the regular procedure for editing code data.

To update the data to be compared while this window is active, click **Re-compare**.

To exit this window, click **Close**.

2.3.4.4 Searching a function code by a character string

Click **Search** in **Edit** on the main menu of the Loader top window while the Function code edit window is active. The Search dialog shown below will appear.

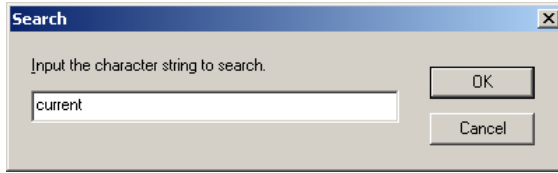

Enter the function code you want to search by a character string in the **Input the character string to search** box, “current” in an example at left, and click **OK**. If the function code including the string is found, Loader automatically opens the Function code edit tab, whose hierarchy tree including the searched function code in its left pane points the Search result that is shown in the right pane.

If you enter an invalid character string, nothing is shown in the right pane as Search result.

Change	Function code No.	Function code name	Setting value	Range of setting
*	P03	Motor (Rated current)	22.51	0.00 to 2000.00 A
	P06	Motor (No-load current)	11.00	0.00 to 2000.00 A
	H12	Instantaneous overcurrent limiting (Select)	1	0 to 1
	M11	Output current effective value	0.00	0.00 to 399.99
	M37	Output current effective value on alarm	0.00	0.00 to 399.99
	M50	Input terminal current [C1] (p.u.)	164.09	-32768 to 32767
	M69	Inverter rated current	22.50	0.00 to 655.35
	W05	Output current	0.00	0.00 to 655.35
	W45	Terminal [C1]input current	16.5	0.0 to 30.0
	W50	FMA output current	4.0	0.0 to 30.0
	W74	Maximum effective current value	0.00	0.00 to 9999
	X21	Latest info. on alarm (output current)	0.00	0.00 to 655.35
	X61	Last info. on alarm (output current)	0.00	0.00 to 655.35
	Z01	Second last info. on alarm (output current)	0.00	0.00 to 655.35
	Z51	Third last info. on alarm (output current)	0.00	0.00 to 9999

At the bottom of the window, there are buttons for 'READ...', 'WRITE...', 'Factory set', 'Func. code set...', 'Func. code info...', 'Initialiaization...', 'Advanced...', and 'Print...'. A 'Select inverter' dropdown menu is set to 'No. 1 [1] INV1' and a 'Close' button is on the far right.

2.3.4.5 File information

This feature allows you to document out contents of the file to be stored in the PC and to edit descriptions to identify the file in the Comment box.

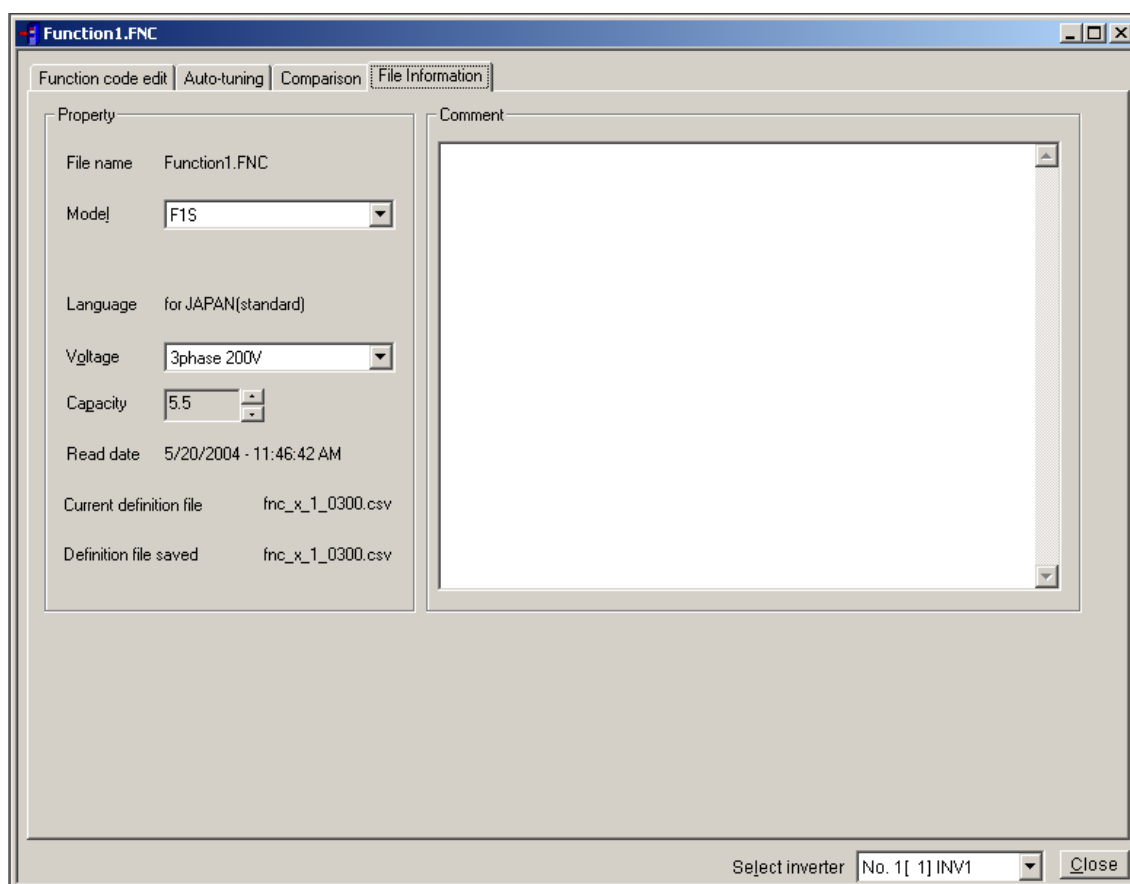

Note If the code data file content currently documented/edited differs from the stored one, Loader probably cannot show the function code stored in the inverter on the Function code edit window, or write the function code data into the inverter while it is shown on the window.

In this case, first write the data file stored in the PC into an inverter and reread it from the inverter for recovery.

2.3.5 Test-running

This feature allows you to test-run the motor in "Run forward" or "Run reverse" while monitoring the running status of the selected inverter.

Select monitor item

Select what is to be displayed here from frequency command, current, etc.

Setting frequency command

Enter or select the set frequency command to write it into the inverter. Click **Apply** to make it effective.

I/O terminal status

Shows status of the programmable I/O terminals of the inverter.

Indicating Operation status

Shows FWD, REV, STOP and Alarm codes.

Operation buttons*

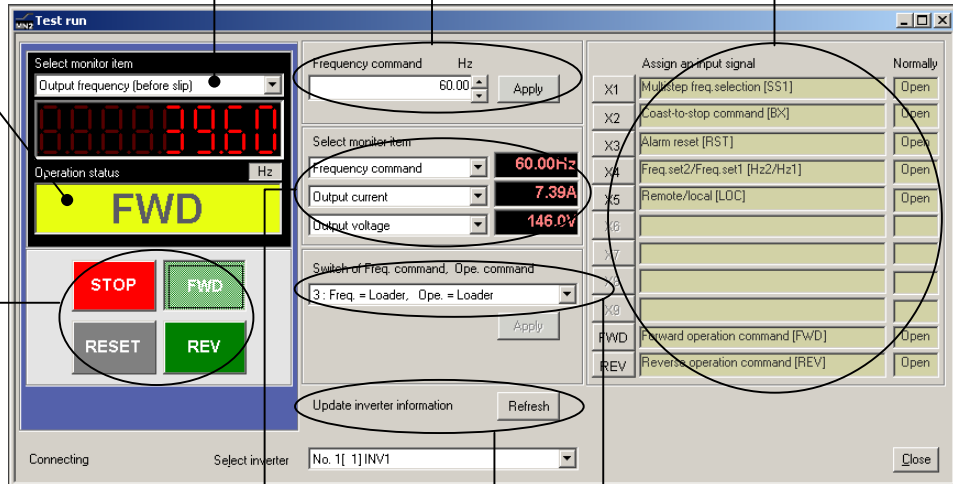

Selecting monitor item

Select the operation status information to be monitored real-time.

Update the inverter info for the latest ones

Click this Update button to update running status of the inverter on Loader. Loader will become to show the latest inverter status.

Switching frequency and operation command sources

Select the frequency and operation command sources and apply them by clicking **Apply**.

* Refer to the table shown below for details of the operation buttons. The indented appearance of the **FWD** button as shown in the figure above indicates that it is active for running the motor forward, while that of the **REV** button is same for running reverse.

Button	Description
STOP	Stops the motor.
FWD	Run the motor forward.
REV	Run the motor reverse.
RESET	Resets all alarm information saved in the selected inverter.

To proceed test-running, select an inverter by clicking the ▼ mark in the **Select inverter** combo-box. At that time Test-running window is first opened, the contents of **Switch of freq. command, Ope. command** is set at "0: Freq. = Inverter, Ope. = Inverter", so that you cannot run the inverter per Loader. That is, the buttons of RUN/REV/STOP and of Assign an input signal for [X1], [X2], [X3], [X4], [X5], [FWD], and [REV] are disabled. These buttons become active only if the setting "Ope. = Loader" is here.

Monitors on this window display the running status of the selected inverter.

Note Changing the selected inverter, first, stops the old inverter and starts running new one for safety. Because of this, to test-run some inverters concurrently, open Test-run windows that can be occupied per inverter.

2.3.5.1 How to setup the inverter and run the motor using Loader

According to the commands you want to issue from Loader, select either [1: Freq. = Loader, Ope. = Inverter], [2: Freq. = Inverter, Ope. = Loader] or [3: Freq. = Loader, Ope. = Loader] by clicking  of the **Switch of freq. command, Ope. command** combo-box. Refer to the table below for details.

Type of command issued from Loader	Switching frequency and operation command sources	Frequency command from Loader	Run buttons STOP, FWD and REV on Loader	Equivalent terminal command buttons X1, X2, X3, X4, X5, FWD and REV on Loader
None	[0: Freq. = Inverter, Ope. = Inverter] (Factory defaults)	Disabled	Disabled	Disabled
Freq. command	[1: Freq. = Loader, Ope. = Inverter]	Enabled	Disabled	Disabled
Ope. command	[2: Freq. = Inverter, Ope. = Loader]	Disabled	Enabled	Enabled
Freq. command and Ope. command	[3: Freq. = Loader, Ope. = Loader]	Enabled	Enabled	Enabled

 **Note** When the function code H30 (Link function) data is not 0, the inverter specifies its command source following the setting of H30 even if Loader selects the inverter as the source. For example, when H30 = 3, the command source remains at 3 even if Loader selects [0: Freq. = Inverter, Ope. = Inverter].

How to issue the frequency and run commands using Loader

Select [3: Freq. = Loader, Ope. = Loader] in the **Switch of freq. command and Ope. command** combo-box and click **Apply**. All items in the **Frequency command** combo-box, drive commands STOP, FWD and REV, and terminal commands X1, X2, X3, X4, X5, FWD and REV will become active. (The terminals X4 and X5 are not applicable to FRENIC-Mini series of inverters.)

To run the motor from Loader, enter or select the frequency in the **Frequency command** combo-box and click **Apply**. To run the motor forward, click **FWD**. To run it reverse, click **REV**. To stop the motor, click **STOP**.

Loader always monitors running status of the inverter(s) in the Test-run window. The monitoring items that can be listed in the dropdown menu of the **Select monitor item** combo-box in the Monitor pane are selectable by clicking the ▼ mark in the combo-box, which are shown in table below. Furthermore for important items, Loader displays the monitoring data in the enlarged format on the display box above the running status monitor box.

In the table below the letter Y in the right columns indicates items that can be listed, while N indicates those that cannot.

Inverter information	For FRENIC-Mini inverters	For FRENIC-Eco inverters
Frequency command	Y	Y
Output frequency (before slip compensation)	Y	Y
Output frequency (after slip compensation)	Y	N
Output current	Y	Y
Output voltage	Y	Y
Motor speed	N	Y
Load shaft speed	Y	Y
Line speed	Y	N
PID process command	Y	Y
PID feedback value	Y	Y
PID output value	N	Y
Output torque	N	Y
Input power	Y	Y
DC link circuit voltage	Y	Y
Analog input for display	N	Y
Operation status	Y	Y

Y: Applicable, N: Not applicable

2.3.5.2 How to recover Loader whose test-run window cannot monitor inverter status

Loader cannot automatically relink inverters when the following event occurs:

- Communications error between Loader and any inverter, and the communication error dialog popped up, and
- The **Cancel** button is clicked to cancel the error, and
- Loader has been recovered from the error state.

In this case, to recover Loader operation, first, open **Device connection list** and click **Browse**, and check the current communications state.

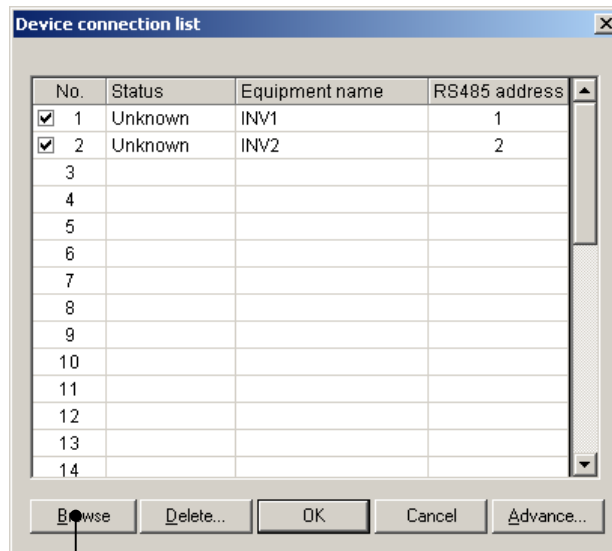

Click **Browse**.

If the communications is alive, for example as shown in the No. 1 row of the figure below, Loader is able to relink the inverter (INV1) and restart monitoring the inverter, to reflect its running status on the Monitor boxes in the Test-run window.

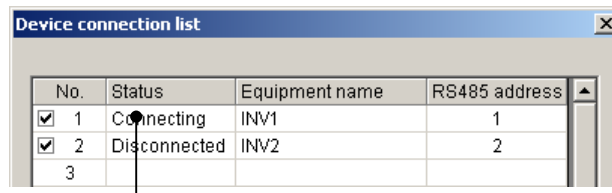

Check that the communication link is alive (Connecting).

⚠ WARNING

While operating the inverter from the Test run window, if Loader or OS freezes or is forced to quit, the inverter(s) cannot be stopped. In such case, stop the inverter operation by doing one of the following:

- 1) Prepare a separate emergency stop switch and use it to stop the inverter.
- 2) Turn the power off to the inverter.
- 3) Turn off the external run commands of the inverter, and switch the command source from communications to the inverter by doing one of the following:
 - Turn off the terminal assigned to the LE command.
 - Set function code y99 (Link support function) to "0" using the keypad.
 - Set function code H30 (Link function) to "0" using the keypad.

IMPORTANT!!

Even after stopping the inverter by one of the methods described above, the inverter will still be holding the data of the function codes related to communications, S05 (frequency command), S06 (run command) and y99 (link support). If you attempt to run it again in this state, the inverter may run the motor unexpectedly. For your safety, reset the data of the function codes (S05, S06, and y99) to "0" following the procedure below before restarting operation.

- 1) Turn the power to the inverter off and then on again to clear the data set inside the inverter.
- 2) First, set data of the function code y99 to "0" using the keypad on the inverter, and then restart Loader. Display the Function code edit window and set the data of function codes S05 and S06 to "0".

2.3.6 Quick access menu

The **Quick access Menu** allows you to access the 9 most frequently used functions (programs) at a single click of the icon.

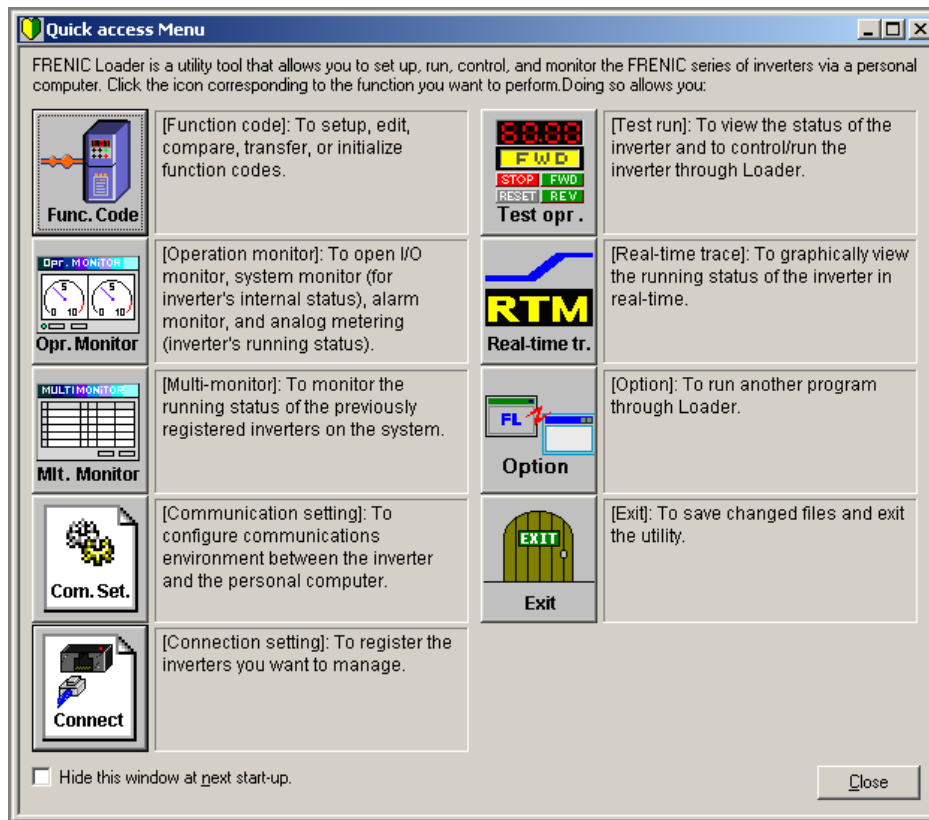

Tip When the **Quick access Menu** has not appeared, click the  icon on the toolbar to call it up.



2.3.7 Option

Using this option you can open a file or program related or unrelated to Loader.

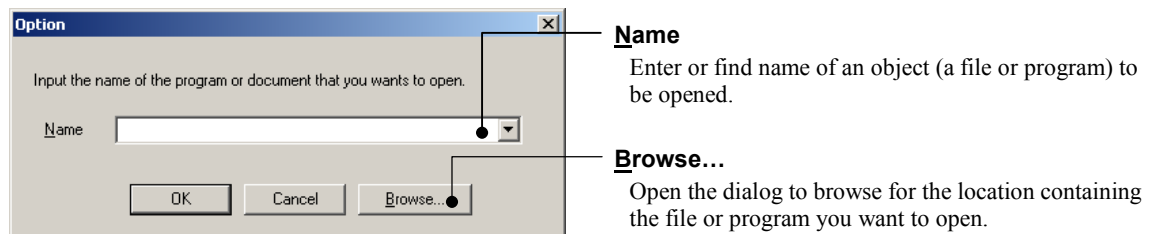

If you have typed in or chosen a file or a program name in the **Name** combo-box, click **OK** to open it.

2.4 View

Specifies how to configure the Loader top window features with show/hide of the Toolbar and Status bar.

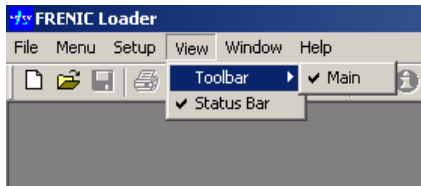

2.4.1 Toolbar

Toolbar is a line usually located the top of the Loader window, which contains programs in cons, and allows you to access the function (program) by single click.

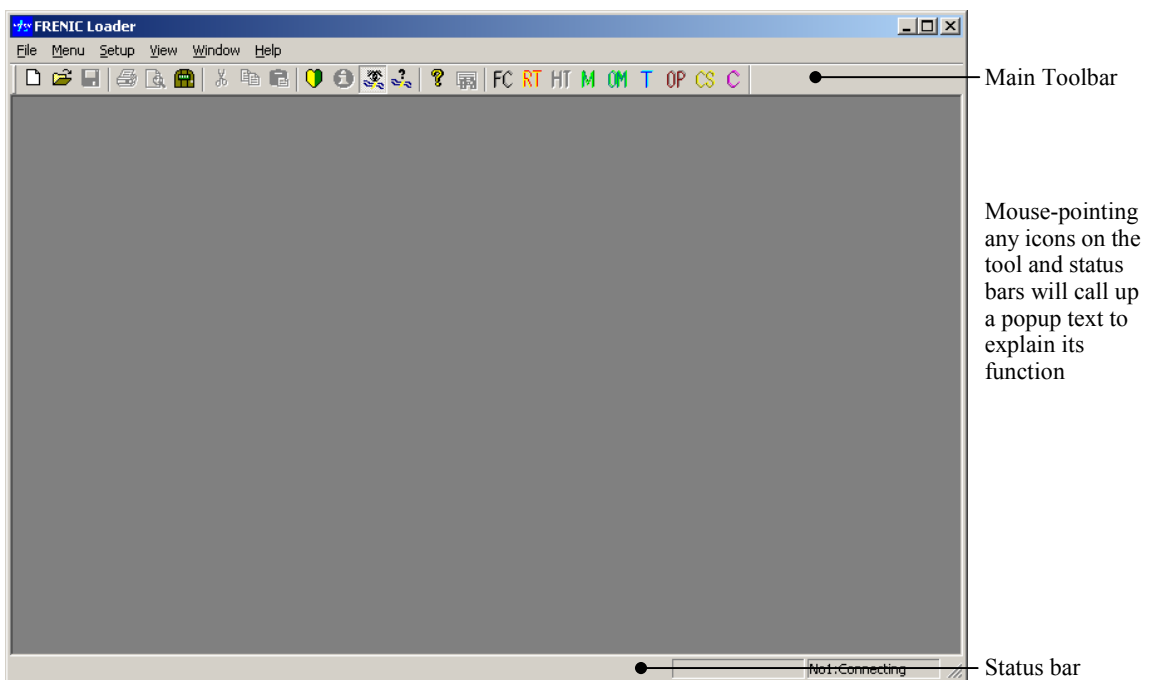

2.4.2 Status bar

Status bar is a line to show information related to Loader, and usually located at the bottom of the Loader window. (See above figure.)

2.5 Window

Specifies how to display the Loader windows on the Loader top window. This facility becomes active only if any window is opened on the top window.

2.5.1 Cascade windows

Cascades the windows opened on the Loader top window. You can call an inactive window up by clicking its title bar.

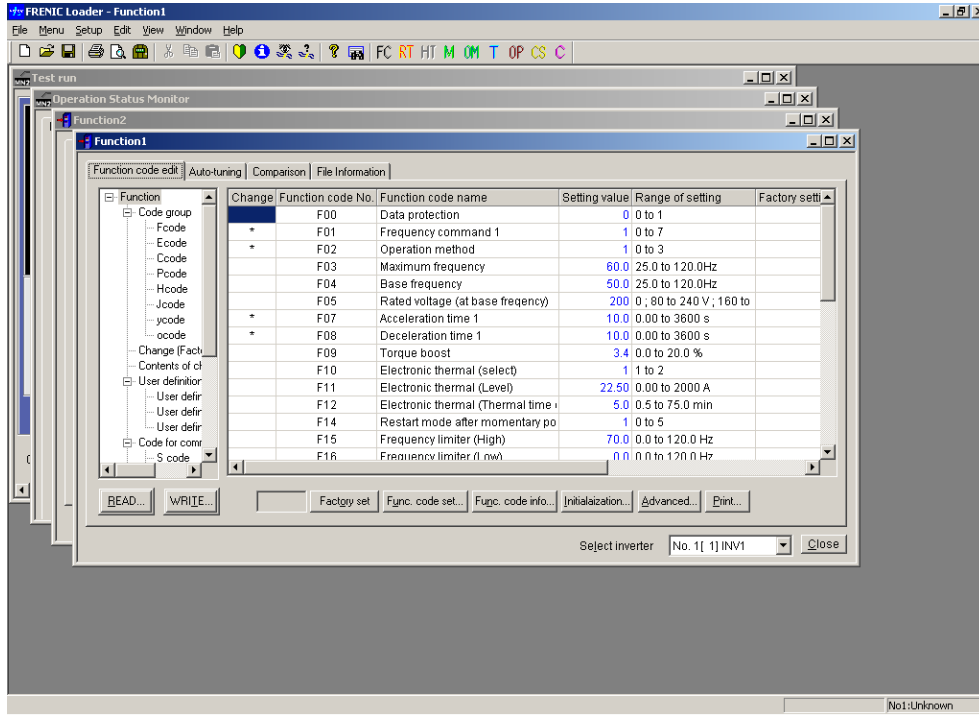

2.5.2 Tile windows

Tiles the windows opened on the Loader top window.

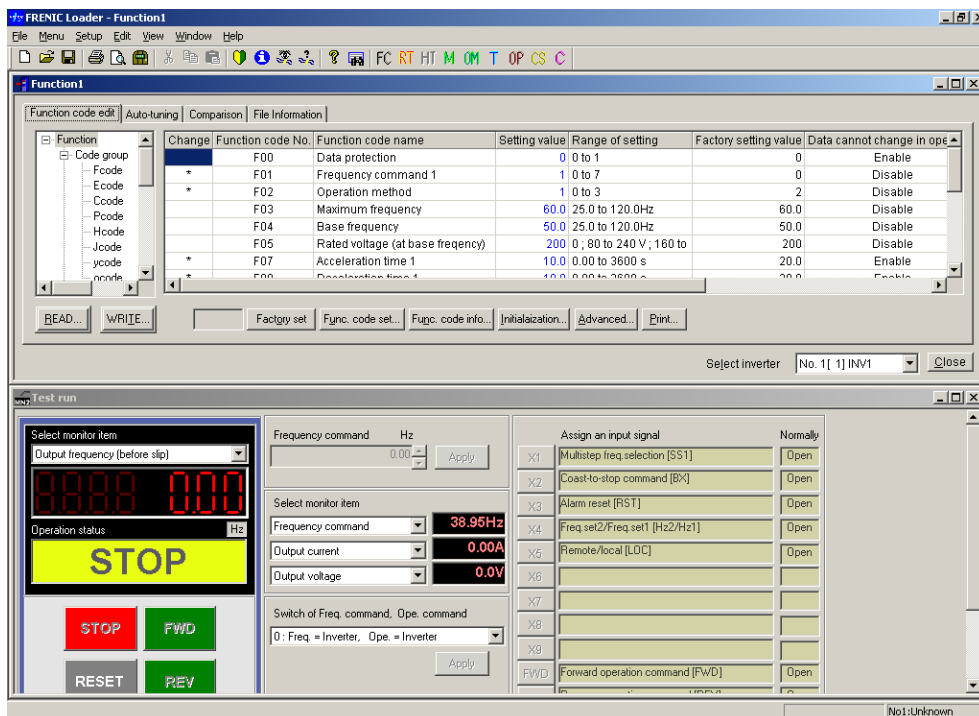

2.5.3 Tile vertically windows

Tiles vertically the windows opened on the Loader top window.

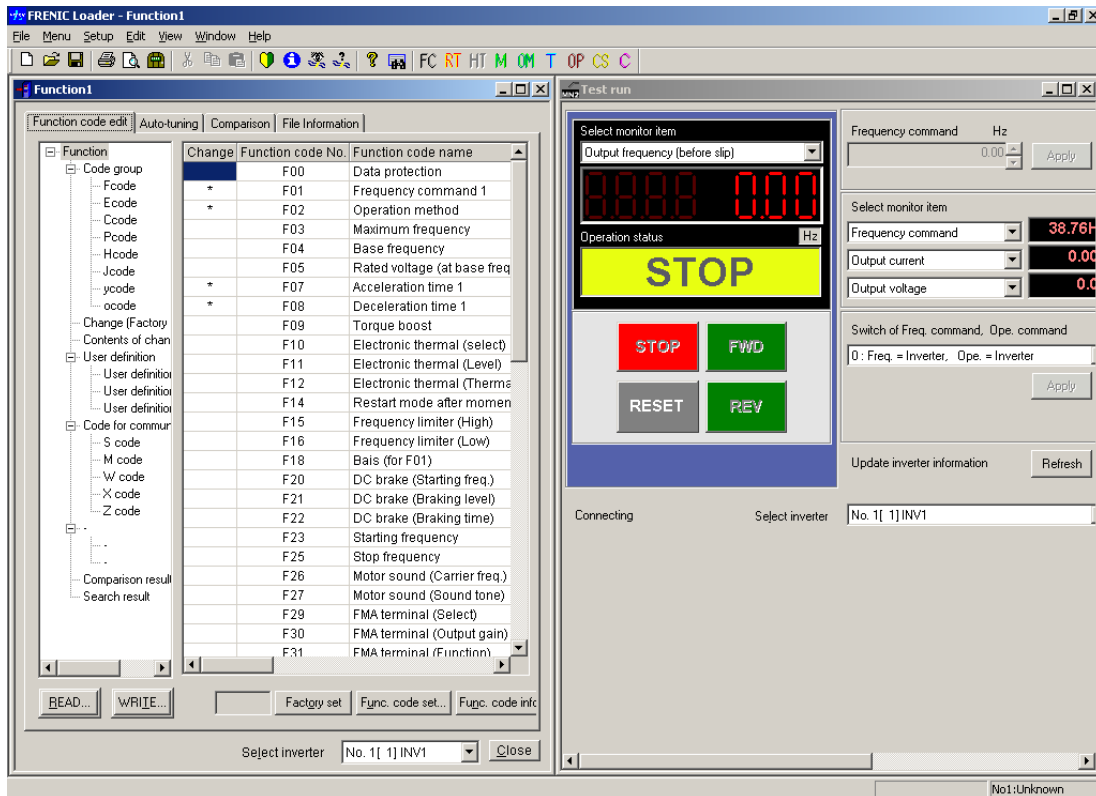

2.5.4 Arrange icons

Arranges icons of the active windows or programs on the bottom part of the Loader top window.

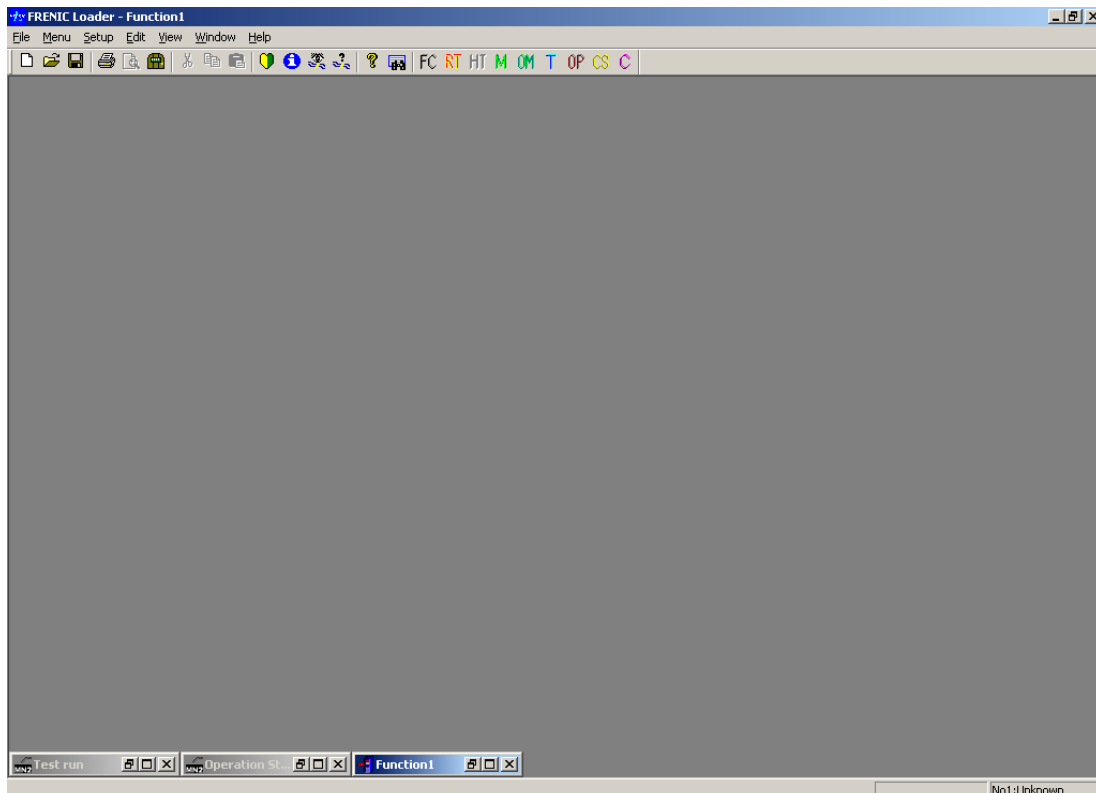

2.6 Help

2.6.1 About FRENIC Loader

Indicates information relating to the FRENIC Loader version, copyright, and license information as shown in the example below.

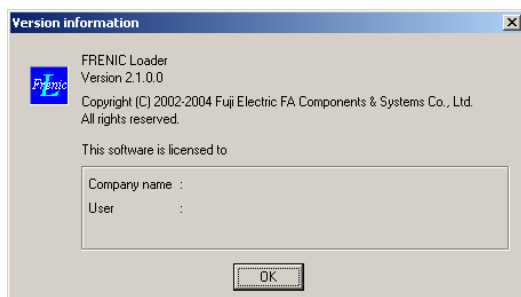

Chapter 3

Reference Information

This chapter contains information concerning use of FRENIC Loader to be referred to as necessary.

Contents

3.1 Troubleshooting	3-1
3.2 Specifications of FRENIC Loader	3-2

3.1 Troubleshooting

If Loader malfunctions or there are any other problems in its operations, follow the steps listed in the troubleshooting chart shown below.

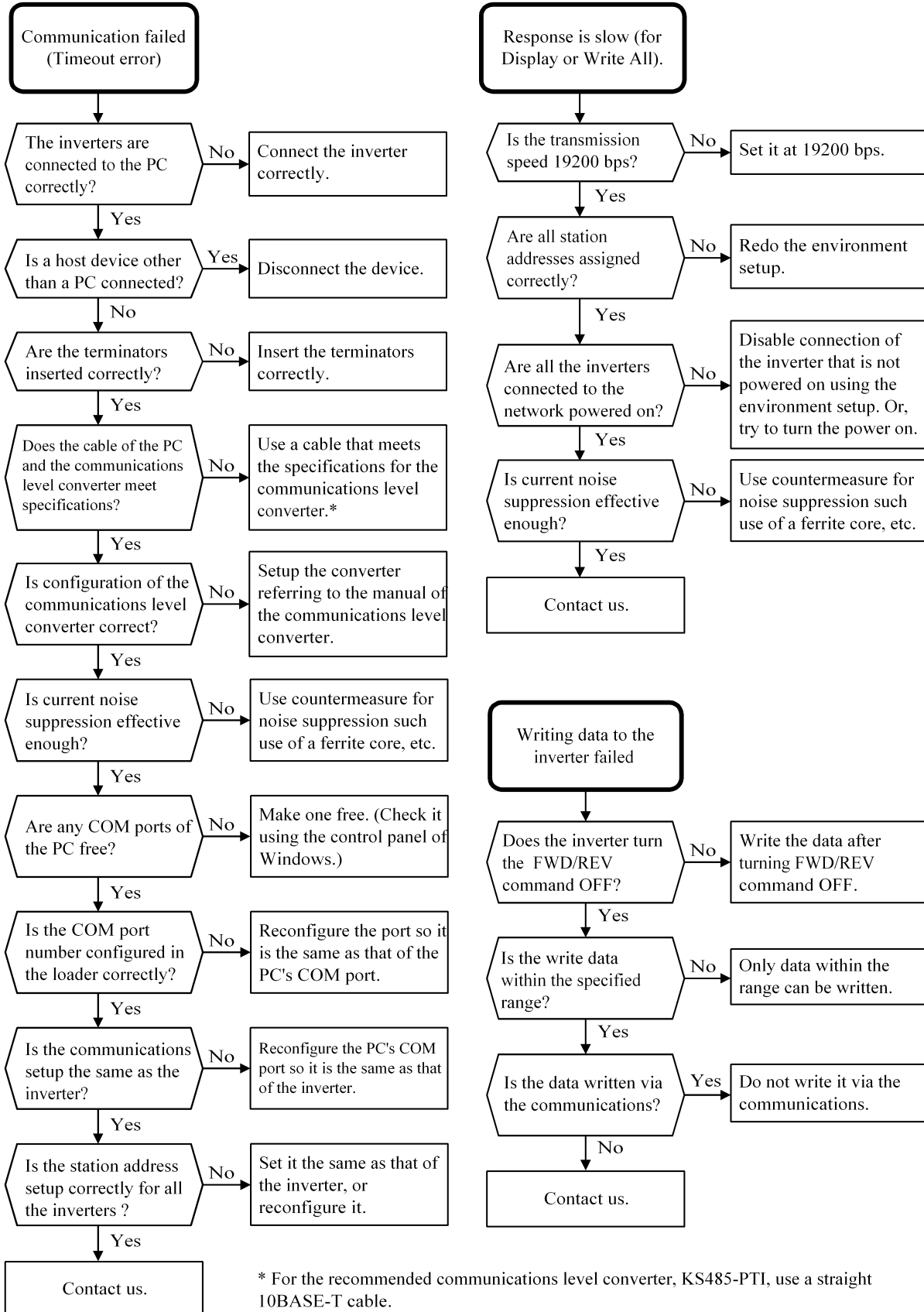

3.2 Specifications of FRENIC Loader

Listed below are the standard specifications of FRENIC Loader at the time this manual was published.

Item	Specification	Remarks	
Name of software	FRENIC Loader		
Supported inverter	FRENIC-Mini series	Note 1	
No. of supported inverters	Up to 31		
Recommended cable	10BASE-T cable with RJ-45 connectors compliant with EIA568		
Operating environment	CPU	Intel Pentium 200MHz with MMX or later	Note 2
	OS	Microsoft Windows 98 Microsoft Windows 2000 Microsoft Windows XP	
	Memory	32 MB or more RAM	64 MB or more is recommended
	Hard disk	5 MB or more free space	
	COM port	RS-232C or USB	Conversion to RS485 communications required to connect inverters
	Monitor resolution	800 × 600 or higher	XGA (1024 × 768)/16 bit color is recommended
Transmission requirements	COM port**	COM1 , COM2, COM3, COM4, COM5, COM6, COM7, COM8	PC COM ports assigned to Loader*
	Transmission rates**	38400, 19200 , 9600, 4800 and 2400 bps	19200 bps or more is recommended. Less than 19200 bps is possible with FRENIC-Minis.
	Character length**	8 bits	Prefixed
	Stop bit length**	1 bit	Prefixed
	Parity**	Even	Prefixed
	No. of retries**	None or 1 to 10	No. of retry times before detecting communications error
	Timeout setting**	(100 ms, 300 ms, 500 ms), (1.0s , 2.0 to 9.0 s) or (10.0 to 60.0 s)	This setting should be longer than the response interval time set for the function code y99.

* To use FRENIC Loader for FRENIC-Mini series of inverters, an RS485 communications card (Option: OPC-C1S-RS) is required.

** White writing on black background indicates the factory default.

Note 1 FRENIC Loader cannot be used with inverters that do not support SX protocol (loader protocol). With special order-made inverters, FRENIC Loader may not be able to display some function codes normally.

Note 2 Use a PC with as high a performance as possible as some slower PCs may not refresh correctly the Operation status monitor and Test run window.

Inverter Support Software
FRENIC Loader

Instruction Manual

First Edition, July 2004

Fuji Electric FA Components & Systems Co., Ltd

The purpose of this manual is to provide an operation guide to FRENIC Loader for the FRENIC-Mini/Eco series of inverters. Please feel free to send your comments regarding any errors or omissions you may have found, or any suggestions you may have for generally improving the manual.
In no event will Fuji Electric FA Components & Systems Co., Ltd be held liable for any direct or indirect damage resulting from the application of the information in this manual.