

USER'S MANUAL

FRENIC ECO SERIES

Designed for Fan and Pump Applications

FRENIC-ECO

User's Manual

Copyright © 2005-2007 Fuji Electric Systems Co., Ltd.

All rights reserved.

No part of this publication may be reproduced or copied without prior written permission from Fuji Electric Systems Co., Ltd.

All products and company names mentioned in this manual are trademarks or registered trademarks of their respective holders.

The information contained herein is subject to change without prior notice for improvement.

Preface

This manual provides all the information on the FRENIC-Eco series of inverters including its operating procedure, operation modes, and selection of peripheral equipment. Carefully read this manual for proper use. Incorrect handling of the inverter may prevent the inverter and/or related equipment from operating correctly, shorten their lives, or cause problems.

The table below lists the other materials related to the use of the FRENIC-Eco. Read them in conjunction with this manual as necessary.

Name	Material No.	Description
Catalog	MEH442	Product scope, features, specifications, external drawings, and options of the product
Instruction Manual	INR-SI47-1059-E	Acceptance inspection, mounting & wiring of the inverter, operation using the keypad, running the motor for a test, troubleshooting, and maintenance and inspection
RS-485 Communication User's Manual	MEH448	Overview of functions implemented by using FRENIC-Eco RS-485 communications facility, its communications specifications, Modbus RTU/Fuji general-purpose inverter protocol and functions, and related data formats
RS-485 Communications Card "OPC-F1-RS" Installation Manual	INR-SI47-0872	Items on acceptance checking, and how to install the card option
Relay Output Card "OPC-F1-RY" Instruction Manual	INR-SI47-0873	Items on acceptance checking, how to install the card option, wiring and specifications
Mounting Adapter for External Cooling "PB-F1" Installation Manual	INR-SI47-0880	Items on acceptance checking, what to apply, and how to install the adapter
Panel-mount Adapter "MA-F1" Installation Manual	INR-SI47-0881	Items on acceptance checking, what to apply, and how to install the adapter
Multi-function Keypad "TP-G1" Instruction Manual	INR-SI47-0890-E	Items on acceptance checking, and how to install and wire the Multi-function Keypad, an operation guide of the keypad, and specifications
FRENIC Loader Instruction Manual	INR-SI47-0903-E	Overview, installation, setting-up, functions, troubleshooting, and specifications of FRENIC Loader

The materials are subject to change without notice. Be sure to obtain the latest editions for use.

Documents related to Fuji inverters

Catalogs

FRENIC-Multi	MEH652
FRENIC-Mini	MEH441/MEH451
FRENIC-Lift	MEH426
FRENIC5000G11S/P11S	MEH403/MEH413
FRENIC5000VG7S	MEH405

User's Manuals and Technical Information

FRENIC-Multi User's Manual	MEH457
FRENIC-Eco User's Manual	MEH456
FRENIC-Mini User's Manual	MEH446
FRENIC5000G11S/P11S & FVR-E11S Technical Information	MEH406
FRENIC5000VG7S User's Manual	MEH263

Guideline for Suppressing Harmonics in Home Electric and General-purpose Appliances

Our three-phase, 200 V class series inverters of 3.7 kW or less (FRENIC-Eco series) were the products of which were restricted by the "Guideline for Suppressing Harmonics in Home Electric and General-purpose Appliances" (established in September 1994 and revised in October 1999) issued by the Ministry of Economy, Trade and Industry.

The above restriction, however, was lifted when the Guideline was revised in January 2004. Since then, the inverter makers have individually imposed voluntary restrictions on the harmonics of their products.

We, as before, recommend that you connect a reactor (for suppressing harmonics) to your inverter. As a reactor, select a "DC REACTOR" introduced in this manual. For use of the other reactor, please inquire of us about detailed specifications.



Japanese Guideline for Suppressing Harmonics by Customers Receiving High Voltage or Special High Voltage

Refer to this manual, Appendix B for details on this guideline.

Safety precautions

Read this manual and the FRENIC-Eco Instruction Manual (INR-SI47-1059-E) thoroughly before proceeding with installation, connections (wiring), operation, or maintenance and inspection. Ensure you have sound knowledge of the product and familiarize yourself with all safety information and precautions before proceeding to operate the inverter.

Safety precautions are classified into the following two categories in this manual.

 WARNING	Failure to heed the information indicated by this symbol may lead to dangerous conditions, possibly resulting in death or serious bodily injuries.
 CAUTION	Failure to heed the information indicated by this symbol may lead to dangerous conditions, possibly resulting in minor or light bodily injuries and/or substantial property damage.

Failure to heed the information contained under the CAUTION title can also result in serious consequences. These safety precautions are of utmost importance and must be observed at all times.

CAUTION

This product is not designed for use in appliances and machinery on which lives depend. Consult your Fuji Electric representative before considering the FRENIC-Eco series of inverters for equipment and machinery related to nuclear power control, aerospace uses, medical uses or transportation. When the product is to be used with any machinery or equipment on which lives depend or with machinery or equipment which could cause serious loss or damage should this product malfunction or fail, ensure that appropriate safety devices and/or equipment are installed.

■ Precautions for Use

In running general-purpose motors	Driving a 400V general-purpose motor	When driving a 400V general-purpose motor with an inverter using extremely long wires, damage to the insulation of the motor may occur. Use an output circuit filter (OFL) if necessary after checking with the motor manufacturer. Fuji motors do not require the use of output circuit filters because of their reinforced insulation.
	Torque characteristics and temperature rise	When the inverter is used to run a general-purpose motor, the temperature of the motor becomes higher than when it is operated using a commercial power supply. In the low-speed range, the cooling effect will be weakened, so decrease the output torque of the motor.
	Vibration	When an inverter-driven motor is mounted to a machine, resonance may be caused by the natural frequencies of the machine system. Note that operation of a 2-pole motor at 60 Hz or higher may cause abnormal vibration. * The use of a rubber coupling or vibration dampening rubber is recommended. * Use the inverter's jump frequency control feature to skip the resonance frequency zone(s).
	Noise	When an inverter is used with a general-purpose motor, the motor noise level is higher than that with a commercial power supply. To reduce noise, raise carrier frequency of the inverter. Operation at 60 Hz or higher can also result in higher level of wind roaring sound.
In running special motors	Explosion-proof motors	When driving an explosion-proof motor with an inverter, use a combination of a motor and an inverter that has been approved in advance.
	Submersible motors and pumps	These motors have a higher rated current than general-purpose motors. Select an inverter whose rated output current is higher than that of the motor. These motors differ from general-purpose motors in thermal characteristics. Set a low value in the thermal time constant of the motor when setting the electronic thermal overcurrent protection (for motor).
	Brake motors	For motors equipped with parallel-connected brakes, their braking power must be supplied from the inverter's primary circuit. If the brake power is connected to the inverter's output circuit by mistake, the brake will not work. Do not use inverters for driving motors equipped with series-connected brakes.
	Geared motors	If the power transmission mechanism uses an oil-lubricated gearbox or speed changer/reducer, then continuous motor operation at low speed may cause poor lubrication. Avoid such operation.
	Synchronous motors	It is necessary to take special measures suitable for this motor type. Contact your Fuji Electric representative for details.
	Single-phase motors	Single-phase motors are not suitable for inverter-driven variable speed operation. Use three-phase motors.

Environmental conditions	Installation location	<p>Use the inverter within the ambient temperature range from -10 to +50°C. The heat sink and braking resistor of the inverter may become hot under certain operating conditions, so install the inverter on nonflammable material such as metal.</p> <p>Ensure that the installation location meets the environmental conditions specified in Chapter 8, Section 8.5 "Operating Environment and Storage Environment."</p>
Combination with peripheral devices	Installing an MCCB or RCD/ELCB	<p>Install a recommended molded case circuit breaker (MCCB) or residual-current-operated protective device (RCD)/earth leakage circuit breaker (ELCB) (with overcurrent protection) in the primary circuit of each inverter to protect the wiring. Ensure that the circuit breaker capacity is equivalent to or lower than the recommended capacity.</p>
	Installing an MC in the secondary circuit	<p>If a magnetic contactor (MC) is installed in the inverter's output (secondary) circuit for switching the motor to commercial power or for any other purpose, ensure that both the inverter and the motor are completely stopped before you turn the MC on or off.</p> <p>Remove a surge killer integrated with the magnet contactor in the inverter's output (secondary) circuit.</p>
	Installing an MC in the primary circuit	<p>Do not turn the magnetic contactor (MC) in the primary circuit on or off more than once an hour as an inverter failure may result.</p> <p>If frequent starts or stops are required during motor operation, use (FWD)/(REV) signals or the RUN/STOP key.</p>
	Protecting the motor	<p>The electronic thermal feature of the inverter can protect the motor. The operation level and the motor type (general-purpose motor, inverter motor) should be set. For high-speed motors or water-cooled motors, set a small value for the thermal time constant.</p> <p>If you connect the motor thermal relay to the motor with a long wire, a high-frequency current may flow into the wiring stray capacitance. This may cause the thermal relay to trip at a current lower than the set value. If this happens, lower the carrier frequency or use the output circuit filter (OFL).</p>
	Discontinuance of power-factor correcting capacitor	<p>Do not connect power-factor correcting capacitors to the inverter's primary circuit. (Use the DC reactor to improve the inverter power factor.) Do not use power-factor correcting capacitors in the inverter's output (secondary) circuit. An overcurrent trip will occur, disabling motor operation.</p>
	Discontinuance of surge killer	<p>Do not connect a surge killer to the inverter's output (secondary) circuit.</p>
	Reducing noise	<p>Use of a filter and shielded wires is typically recommended to satisfy EMC Directives.</p> <p>Refer to Appendices, App. A "Advantageous Use of Inverters (Notes on electrical noise)" for details.</p>
	Measures against surge currents	<p>If an overvoltage trip occurs while the inverter is stopped or operated under light load, it is assumed that the surge current is generated by open/close of the phase-advancing capacitor in the power system.</p> <p>* Connect a DC reactor to the inverter.</p>
	Megger test	<p>When checking the insulation resistance of the inverter, use a 500 V megger and follow the instructions contained in the FRENIC-Eco Instruction Manual (INR-SI47-1059-E), Chapter 7, Section 7.5 "Insulation Test."</p>

Wiring	Control circuit wiring length	When using remote control, limit the wiring length between the inverter and operator box to 20 m or less and use twisted pair or shielded wire.
	Wiring length between inverter and motor	If long wiring is used between the inverter and the motor, the inverter may overheat or trip due to overcurrent because a higher harmonics current flows into the stray capacitance between each phase wire. Ensure that the wiring is shorter than 50 m. If this length must be exceeded, lower the carrier frequency or install an output circuit filter (OFL).
	Wire size	Select wires with a sufficient capacity by referring to the current value or recommended wire size.
	Wire type	Do not share one multi-core cable in order to connect several inverters with motors.
	Grounding	Securely ground the inverter using the grounding terminal.
Selecting inverter capacity	Driving general-purpose motor	Select an inverter according to the applicable motor ratings listed in the standard specifications table for the inverter. When high starting torque is required or quick acceleration or deceleration is required, select an inverter with a capacity one size greater than the standard. Refer to Chapter 7, Section 7.1 "Selecting Motors and Inverters" for details.
	Driving special motors	Select an inverter that meets the following condition: Inverter rated current > Motor rated current
Transportation and storage	When transporting or storing inverters, follow the procedures and select locations that meet the environmental conditions listed in the FRENIC-Eco Instruction Manual (INR-SI47-1059-E), Chapter 1, Section 1.3 "Transportation" and Section 1.4 "Storage Environment."	

How this manual is organized

This manual contains Chapters 1 through 10, Appendices and Glossary.

Part 1 General Information

Chapter 1 INTRODUCTION TO FRENIC-Eco

This chapter describes the features and control system of the FRENIC-Eco series, and the recommended configuration for the inverter and peripheral equipment.

Chapter 2 PARTS NAMES AND FUNCTIONS

This chapter contains external views of the FRENIC-Eco series and an overview of terminal blocks, including a description of the LED display and keys on the keypad.

Chapter 3 OPERATION USING THE KEYPAD

This chapter describes inverter operation using the keypad. The inverter features three operation modes (Running, Programming and Alarm modes) which enable you to run and stop the motor, monitor running status, set function code data, display running information required for maintenance, and display alarm data.

The keypad is available in two types: standard keypad and optional multi-function keypad. For the instructions on how to operate the multi-function keypad, refer to the "Multi-function Keypad Instruction Manual" (INR-SI47-0890-E).

Part 2 Driving the Motor

Chapter 4 BLOCK DIAGRAMS FOR CONTROL LOGIC

This chapter describes the main block diagrams for the control logic of the FRENIC-Eco series of inverters.

Chapter 5 RUNNING THROUGH RS-485 COMMUNICATION

This chapter describes an overview of inverter operation through the RS-485 communications facility. Refer to the RS-485 Communication User's Manual (MEH448) or RS-485 Communications Card "OPC-F1-RS" Installation Manual (INR-SI47-0872) for details.

Part 3 Peripheral Equipment and Options

Chapter 6 SELECTING PERIPHERAL EQUIPMENT

This chapter describes how to use a range of peripheral equipment and options, FRENIC-Eco's configuration with them, and requirements and precautions for selecting wires and crimp terminals.

Part 4 Selecting Optimal Inverter Model

Chapter 7 SELECTING OPTIMAL MOTOR AND INVERTER CAPACITIES

This chapter provides you with information about the inverter output torque characteristics, selection procedure, and equations for calculating capacities to help you select optimal motor and inverter models. It also helps you select braking resistors.

Chapter 8 SPECIFICATIONS

This chapter describes specifications of the output ratings, control system, and terminal functions for the FRENIC-Eco series of inverters. It also provides descriptions of the operating and storage environment, external dimensions, examples of basic connection diagrams, and details of the protective functions.

Chapter 9 FUNCTION CODES

This chapter contains overview lists of seven groups of function codes available for the FRENIC-Eco series of inverters and details of each function code.

Chapter 10 TROUBLESHOOTING

This chapter describes troubleshooting procedures to be followed when the inverter malfunctions or detects an alarm condition. In this chapter, first check whether any alarm code is displayed or not, and then proceed to the troubleshooting items.

Appendices

- App. A Advantageous Use of Inverters (Notes on electrical noise)
- App. B Japanese Guideline for Suppressing Harmonics by Customers Receiving High Voltage or Special High Voltage
- App. C Effect on Insulation of General-purpose Motors Driven with 400 V Class Inverters
- App. D Inverter Generating Loss
- App. E Conversion from SI Units
- App. F Allowable Current of Insulated Wires

Glossary

Icons

The following icons are used throughout this manual.



This icon indicates information which, if not heeded, can result in the inverter not operating to full efficiency, as well as information concerning incorrect operations and settings which can result in accidents.



This icon indicates information that can prove handy when performing certain settings or operations.



This icon indicates a reference to more detailed information.

CONTENTS

Part 1 General Information

Chapter 1 INTRODUCTION TO FRENIC-Eco

1.1	Features	1-1
1.2	Control System.....	1-19
1.3	Recommended Configuration	1-20

Chapter 2 PARTS NAMES AND FUNCTIONS

2.1	External View and Allocation of Terminal Blocks	2-1
2.2	LED Monitor, Keys and LED Indicators on the Keypad	2-3

Chapter 3 OPERATION USING THE KEYPAD

3.1	Overview of Operation Modes	3-1
3.2	Running Mode	3-3
3.2.1	Monitoring the running status	3-3
3.2.2	Setting up frequency and PID process commands.....	3-4
3.2.3	Running/stopping the motor.....	3-7
3.3	Programming Mode	3-11
3.3.1	Setting up basic function codes quickly -- Menu #0 "Quick Setup" --.....	3-13
3.3.2	Setting up function codes -- Menu #1 "Data Setting" --.....	3-17
3.3.3	Checking changed function codes -- Menu #2 "Data Checking" --.....	3-18
3.3.4	Monitoring the running status -- Menu #3 "Drive Monitoring" --.....	3-19
3.3.5	Checking I/O signal status -- Menu #4 "I/O Checking" --.....	3-22
3.3.6	Reading maintenance information -- Menu #5 "Maintenance Information" --.....	3-26
3.3.7	Reading alarm information -- Menu #6 "Alarm Information" --.....	3-29
3.3.8	Data copying information -- Menu #7 "Data Copying" --.....	3-31
3.4	Alarm Mode.....	3-35
3.4.1	Releasing the alarm and switching to Running mode.....	3-35
3.4.2	Displaying the alarm history	3-35
3.4.3	Displaying the status of inverter at the time of alarm	3-35
3.4.4	Switching to Programming mode	3-35

Part 2 Driving the Motor

Chapter 4 BLOCK DIAGRAMS FOR CONTROL LOGIC

4.1	Symbols Used in Block Diagrams and their Meanings.....	4-1
4.2	Drive Frequency Command Generator.....	4-2
4.3	Drive Command Generator.....	4-4
4.4	Digital Terminal Command Decoder.....	4-6
4.4.1	Terminals and related function codes.....	4-6
4.4.2	Functions assigned to digital control input terminals	4-7
4.4.3	Block diagrams for digital control input terminals	4-8
4.5	Digital Output Selector	4-12
4.5.1	Digital output components (Internal block).....	4-12
4.5.2	Universal DO (Access to the function code S07 exclusively reserved for the communications link).....	4-15
4.6	Analog Output (FMA and FMI) Selector	4-16
4.7	Drive Command Controller	4-17
4.8	PID Frequency Command Generator	4-19

Chapter 5 RUNNING THROUGH RS-485 COMMUNICATION

5.1	Overview on RS485 Communication	5-1
5.1.1	RS-485 common specifications (standard and optional)	5-2
5.1.2	RJ-45 connector pin assignment for standard RS-485 communications port	5-3
5.1.3	Pin assignment for optional RS-485 Communications Card	5-4
5.1.4	Cable for RS-485 communications port	5-4
5.1.5	Communications support devices	5-5
5.2	Overview of FRENIC Loader	5-6
5.2.1	Specifications	5-6
5.2.2	Connection	5-7
5.2.3	Function overview	5-7
5.2.3.1	Setting of function code	5-7
5.2.3.2	Multi-monitor	5-8
5.2.3.3	Running status monitor	5-9
5.2.3.4	Test-running	5-10
5.2.3.5	Real-time trace—Displaying running status of an inverter in waveforms	5-11

Part 3 Peripheral Equipment and Options

Chapter 6 SELECTING PERIPHERAL EQUIPMENT

6.1	Configuring the FRENIC-Eco	6-1
6.2	Selecting Wires and Crimp Terminals	6-2
6.2.1	Recommended wires	6-4
6.3	Peripheral Equipment	6-8
6.4	Selecting Options	6-14
6.4.1	Peripheral equipment options	6-14
6.4.2	Options for operation and communications	6-22
6.4.3	Extended installation kit options	6-27
6.4.4	Meter options	6-29

Part 4 Selecting Optimal Inverter Model

Chapter 7 SELECTING OPTIMAL MOTOR AND INVERTER CAPACITIES

7.1	Selecting Motors and Inverters	7-1
7.1.1	Motor output torque characteristics	7-1
7.1.2	Selection procedure	7-3
7.1.3	Equations for selections	7-6
7.1.3.1	Load torque during constant speed running	7-6
7.1.3.2	Acceleration and deceleration time calculation	7-7
7.1.3.3	Heat energy calculation of braking resistor	7-10

Part 5 Specifications and Troubleshooting

Chapter 8 SPECIFICATIONS

8.1	Standard Models	8-1
8.1.1	Three-phase 400 V series	8-1
8.2	Common Specifications	8-3
8.3	Terminal Specifications	8-6
8.3.1	Terminal functions.....	8-6
8.3.2	Terminal arrangement diagram and screw specifications	8-25
8.3.2.1	Main circuit terminals	8-25
8.3.2.2	Control circuit terminals	8-27
8.4	Operating Environment and Storage Environment.....	8-28
8.4.1	Operating environment.....	8-28
8.4.2	Storage environment	8-29
8.4.2.1	Temporary storage.....	8-29
8.4.2.2	Long-term storage	8-29
8.5	External Dimensions.....	8-30
8.5.1	Standard models	8-30
8.5.2	DC reactor	8-33
8.5.3	Standard keypad	8-34
8.6	Connection Diagrams.....	8-35
8.6.1	Running the inverter with keypad.....	8-35
8.6.2	Running the inverter by terminal commands	8-36
8.7	Protective Functions.....	8-38

Chapter 9 FUNCTION CODES

9.1	Function Code Tables.....	9-1
9.2	Overview of Function Codes	9-22
9.2.1	F codes (Fundamental functions).....	9-22
9.2.2	E codes (Extension terminal functions)	9-51
9.2.3	C codes (Control functions of frequency).....	9-90
9.2.4	P codes (Motor parameters)	9-94
9.2.5	H codes (High performance functions).....	9-97
9.2.6	J codes (Application functions).....	9-119
9.2.7	y codes (Link functions).....	9-130

Chapter 10 TROUBLESHOOTING

10.1	Before Proceeding with Troubleshooting	10-1
10.2	If No Alarm Code Appears on the LED Monitor	10-2
10.2.1	Motor is running abnormally	10-2
10.2.2	Problems with inverter settings.....	10-7
10.3	If an Alarm Code Appears on the LED Monitor.....	10-8
10.4	If an Abnormal Pattern Appears on the LED Monitor while No Alarm Code is Displayed	10-19

Appendices

App.A	Advantageous Use of Inverters (Notes on electrical noise)	A-1
A.1	Effect of inverters on other devices	A-1
A.2	Noise	A-2
A.3	Noise prevention	A-4
App.B	Japanese Guideline for Suppressing Harmonics by Customers Receiving High Voltage or Special High Voltage	A-12
B.1	Application to general-purpose inverters	A-12
B.2	Compliance to the harmonic suppression for customers receiving high voltage or special high voltage	A-13
App.C	Effect on Insulation of General-purpose Motors Driven with 400 V Class Inverters	A-17
C.1	Generating mechanism of surge voltages	A-17
C.2	Effect of surge voltages	A-18
C.3	Countermeasures against surge voltages	A-18
C.4	Regarding existing equipment	A-19
App.D	Inverter Generating Loss	A-20
App.E	Conversion from SI Units	A-21
App.F	Allowable Current of Insulated Wires	A-23

Glossary

Part 1 General Information



Chapter 1 INTRODUCTION TO FRENIC-Eco

Chapter 2 PARTS NAMES AND FUNCTIONS

Chapter 3 OPERATION USING THE KEYPAD

Chapter 1

INTRODUCTION TO FRENIC-Eco

This chapter describes the features and control system of the FRENIC-Eco series and the recommended configuration for the inverter and peripheral equipment.

Contents

1.1	Features	1-1
1.2	Control System	1-19
1.3	Recommended Configuration	1-20

1.1 Features

Default functions for fans and pumps

■ Switching motor power between commercial lines and inverter outputs

The FRENIC-Eco series of inverters is equipped with built-in sequence control logic that supports starting of the motor via the commercial lines by using an external sequence and switches the motor power between commercial lines and inverter outputs. This feature simplifies the user's power control system configuration.

In addition to this Fuji's standard switching sequence, an auto-switching sequence is also available upon occurrence of an inverter alarm.

The schematic diagram below shows a typical sequence control circuit externally configured for an effective application of the sequence control logic.

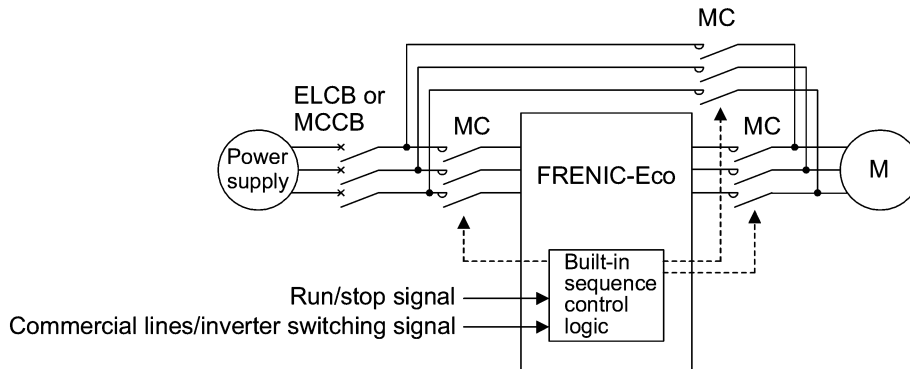

Refer to function codes E01 to E05 in Section 9.2.2 "E codes" and J22 in Section 9.2.6 "J codes."

■ Full PID control functions

The PID control has the "slow flowrate stop" and "deviation alarm/absolute value alarm output" functions. It also supports a variety of manual speed (frequency) commands to make a balance-less and bump-less switching available that automatically adjusts the output frequency against the frequency command.

Further, the PID control has an anti-reset wind-up function for prevention of overshooting, as well as supporting PID output limiter and integration hold/reset signals, facilitating the adjustment necessary for PID control.

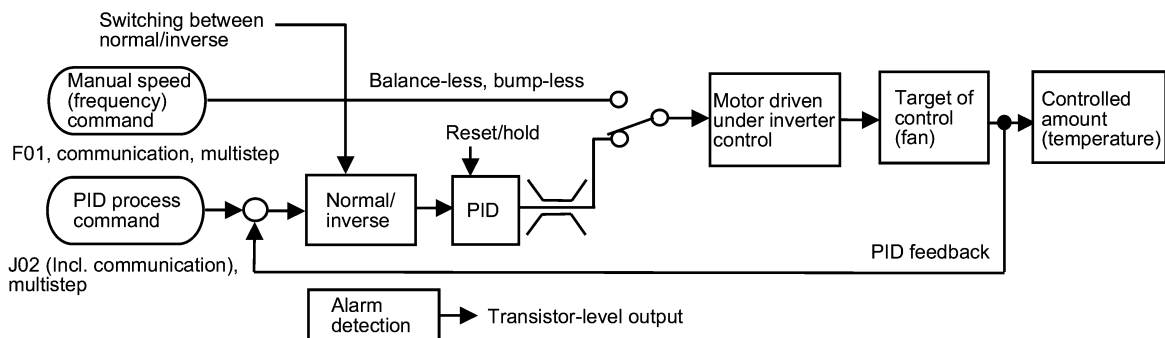

Refer to the PID Frequency Command Generator in Section 4.8, function codes E01 to E05, E20 to E22, E24, and E27 in Section 9.2.2 "E codes," and J01 to J06, J10 to J13, and J15 to J19 in Section 9.2.6 "J codes."

■ Slow flowrate stop function

A new function called slow flowrate stop is now added to the low limiter for securing the minimum operation speed of a fan and pump, etc., whereby the operation will stop if the flowrate drops and remains below the low limit for a certain length of time. This, combined with PID control, contributes to more energy-saving operation.

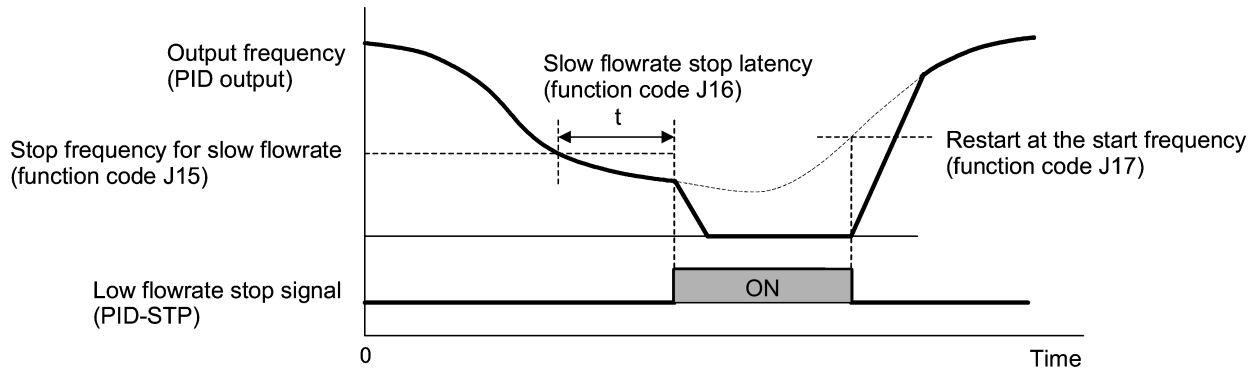

Refer to function codes E20 to E22, E24, and E27 in Section 9.2.2 "E codes" and J15, J16, and J17 in Section 9.2.6 "J codes."

■ Command loss detection

The analog frequency command is monitored and when an abnormal condition is detected, an alarm signal is output. Further, if in a critical system such as an air conditioner for an important facility, an abnormal condition is detected in the circuit handling the analog frequency command source, the system will be stopped or will continue its operation at the specified speed (at the specified percentage of the command just before the detection of the abnormal condition).

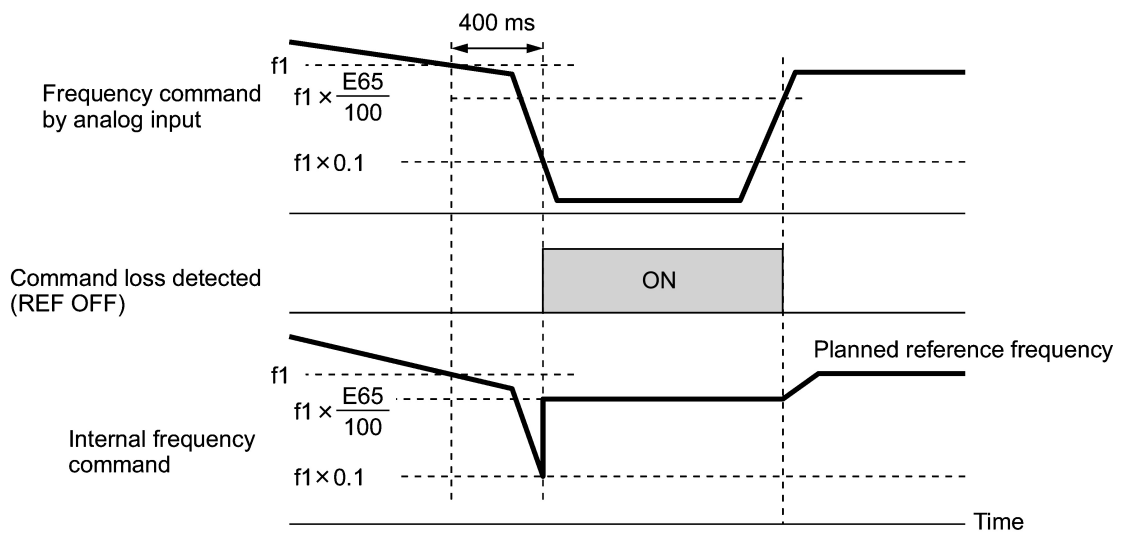

Refer to function codes E20 to E22, E24, E27, and E65 in Section 9.2.2 "E codes."

■ **Low output torque detection**

A low output torque detection signal is asserted in the event of sudden decrease in torque as a result of an abnormal condition such as the belt being broken between the motor and the load (e.g., a belt-driven fan). This signal, which indicates abnormal conditions occurring in the facility (load), can therefore be used as maintenance information.

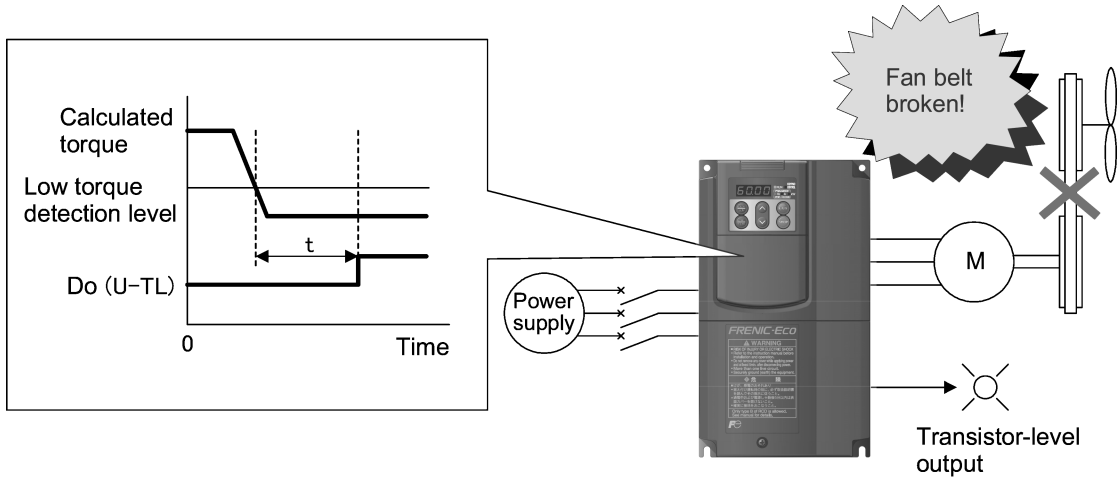

Refer to function codes E20 to E22, E24, E27, E80 and E81 in Section 9.2.2 "E codes."

■ **Continuous operation at momentary power failure**

You can choose either tripping or automatic restart in the event of a momentary power failure. You can choose starting at the frequency at the momentary power failure occurrence or starting at 0 Hz, according to the requirement. Further, you can choose a control mode to prolong the running time utilizing the kinetic energy due to the load's moment of inertia during the momentary power failure.

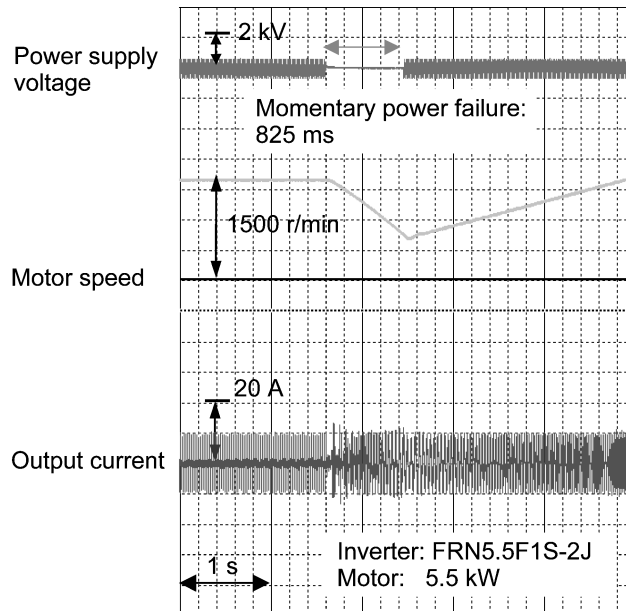



<Example of continued operation in the event of a momentary power failure>

Refer to function code F14 in Section 9.2.1 "F codes."

■ Switching between remote and local modes

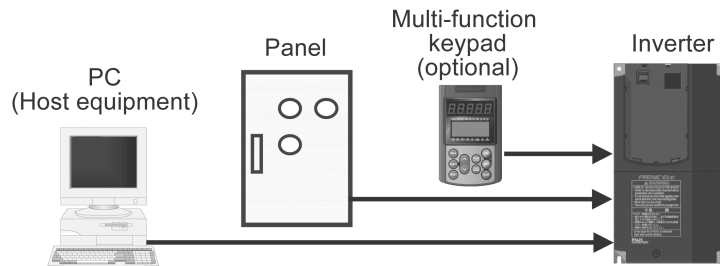
You can choose a mode of inverter operation between remote (communications link or terminal commands) and local (keypad in any location such as built-in or on the panel) for both run commands and frequency commands, with combination sets of frequency command 1 and frequency command 2, run command 1 and run command 2.



 Refer to Running/stopping the motor in Section 3.2.3 and function codes F01 and F02 in Section 9.2.1 "F codes."

■ Auto search for idling motor's speed

The auto search feature helps the idling motor start smoothly, by setting an auto search frequency. When the motor is in idling state due to natural convection, momentary power failure or other similar situations, the inverter can automatically search for the current motor speed and direction and start/restart the motor smoothly from the frequency that can be harmonized with the current motor speed and rotation, without stopping it. For restart after a recovery from the momentary power failure, you have a choice of two frequencies--the frequency saved at the power failure and the starting frequency.

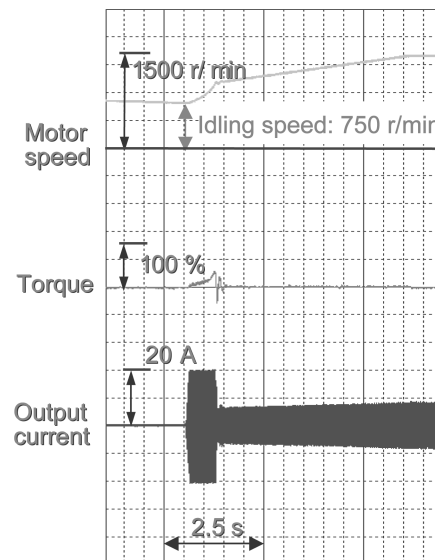

<Example of operation in auto sync search feature>

 Refer to function codes H09 and H17 in Section 9.2.5 "H codes."

■ Choosing from a variety of frequency command sources

A variety of frequency command sources are provided to match your power system as listed below.

- Keypad (⤴ / ⤵ keys)

The keypad allows you to set a frequency command as an output frequency, motor speed, load shaft speed, percentage to the maximum frequency, etc.

- Analog terminal inputs

You can set up analog inputs with the following signals, either individually or in combination of them.

- 4 to 20 mA DC [C1] or 0 to 10 VDC [12]
- Inverse of the above signals
- Voltage input terminal for analog setting [V2] (built-in)

- Multistep frequency (8 steps)
- UP/DOWN operation
- Switching between frequency commands 1 and 2
- Suitable manipulation (addition) of frequencies, available by using auxiliary frequency commands 1 and 2
- RS-485 communications link facility supported as standard
- Switching between remote and local modes

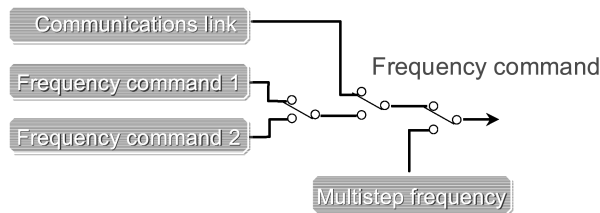

 Refer to function code F01 in Section 9.2.1 "F codes," E01 to E05 and E61 to E63 in Section 9.2.2 "E codes," and H30 in Section 9.2.5 "H codes."

■ Monitor for analog input

The inverter is equipped with input terminals for accepting analog signals from the outside equipment or the motor. By connecting the outputs of a flow meter, a pressure gauge, or any other sensor, you can display them on the LED monitor on the keypad that shows their physical values in easy-to-understand analog values (multiplied with a specified coefficient in some cases). It is also possible to build a host-controlled system by sending/receiving such information via the communications link to/from a host computer.

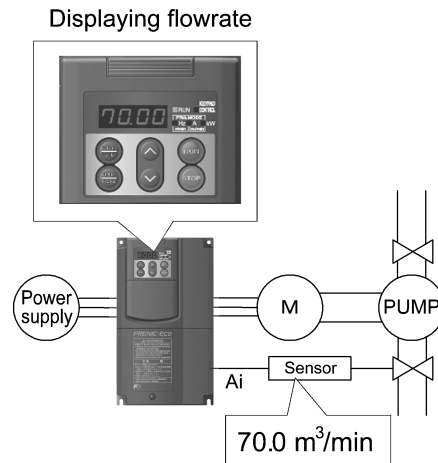

<Example of monitoring system>

 Refer to function codes E43, E45, and E48 in Section 9.2.2 "E codes."

Contribution to energy-saving

■ Automatic energy-saving (standard feature)

A new, automatic energy-saving function is included as a standard feature, which controls the system to minimize the total loss (motor loss plus inverter loss), rather than just the motor loss as in the predecessor models. This feature thus contributes to further energy saving in applications with fans and pumps.

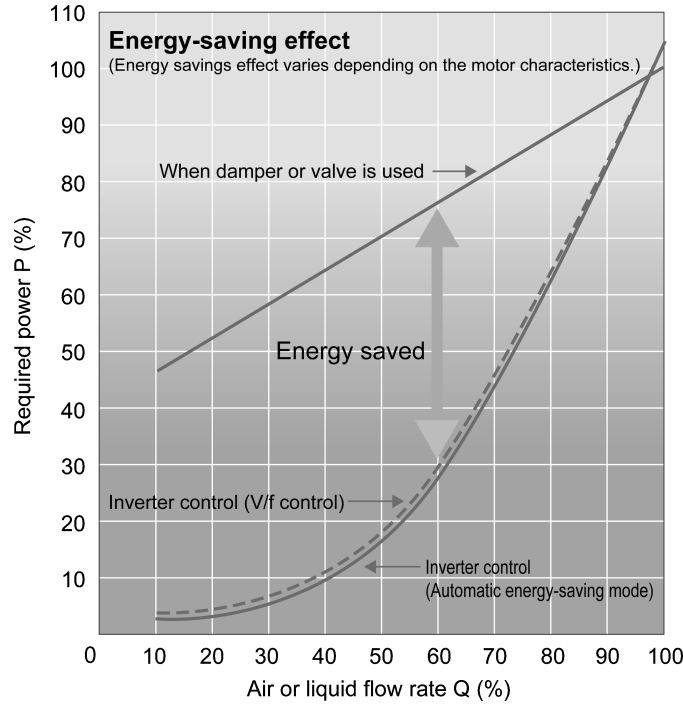

Figure 1.1 Example of Energy-Saving

Refer to the Drive Command Controller in Section 4.7 and function codes F09 and F37 in Section 9.2.1 "F codes."

■ Monitoring electric power

In addition to electric power monitoring on the standard keypad (or optional multi-function keypad), online monitoring is available from the host equipment through the communications link.

This function monitors real-time power consumption, cumulative power consumption in watt-hours, and cumulative power consumption with a specified coefficient (such as an electricity charge).

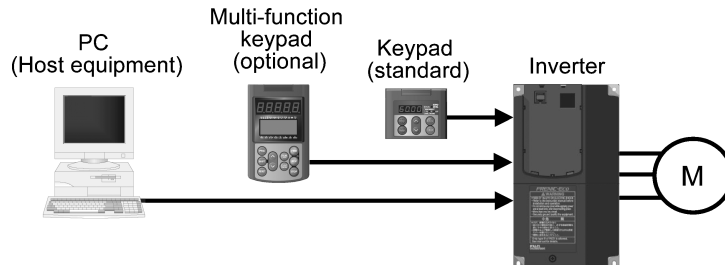

Refer to Chapter 3 "OPERATION USING THE KEYPAD" and Chapter 5 "RUNNING THROUGH RS-485 COMMUNICATION."

■ PID control supported

PID control, which is a standard feature on the inverter, allows you to control temperature, pressure, and flowrate without using any external adjustment devices so that you can configure a temperature control system without an external thermal conditioner.



Refer to the PID Frequency Command Generator in Section 4.8 and function codes J01 to J06 in Section 9.2.6 "J codes."

■ Cooling fan ON/OFF control

The inverter's cooling fan can be stopped whenever the inverter does not output power. This contributes to noise reduction, longer service life, and energy saving.



Refer to function codes E20 to E22, E24, and E27 in Section 9.2.2 "E codes" and H06 in Section 9.2.5 "H codes."

Consideration for surrounding environment

■ Reactor built-in type added to standard line-up

A DC reactor for power-factor correction is now integrated in the inverter (for the range of 0.75 to 55 kW). In addition, a zero-phase reactor (ferrite ring) and a capacitive filter are integrated in the inverters of 22 kW or below. These features simplify the power-related wiring (no need for DC reactor and capacitive filter wiring). The new good-shortcut wiring feature also fully covers Standard Specifications for Public Building Construction set by the Japanese Ministry of Land, Infrastructure and Transport (Volume for Electric Facilities and Volume for Mechanical Facilities).

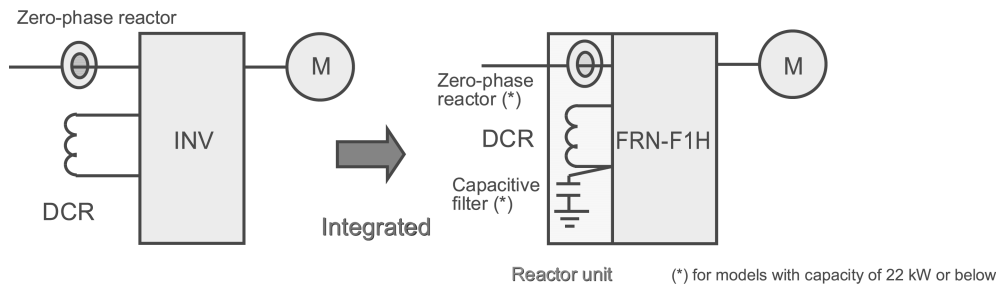

Refer to Chapter 6 "SELECTING PERIPHERAL EQUIPMENT."

■ Inrush current suppression circuit integrated in all models

An inrush current suppression circuit is integrated as standard in all models, therefore the cost of peripheral devices such as magnetic contactor (MC) can be reduced.

■ EMC-filter built-in type added to semi-standard line-up

The product can be used to fully comply with the EMC Directives in EU. (15 kW or below)

■ Standard installation of input terminals for auxiliary control power of all models

The auxiliary control input terminals provide a convenient shortcut for automatic input power source switching between commercial line and inverter as standard terminals.

Refer to Section 8.4 "Terminal Specifications."

Various functions for protection and easy maintenance

FRENIC-Eco series features the following facilities useful for maintenance.

Refer to Chapter 3 "OPERATION USING THE KEYPAD" in this manual and the "FRENIC-Eco Instruction Manual" (INR-SI47-1059-E), Chapter 7 "MAINTENANCE AND INSPECTION."

■ Lifetime estimation for DC link bus capacitors (reservoir capacitors)

This function shows the lifetime of the DC link bus capacitor as a ratio to its initial capacitance value, helping you determine the replacement timing of the capacitor. (Design life of DC link bus capacitors: 10 years under these conditions: load = 80% of inverter's rated current; ambient temperature = 40°C)

■ Long-life fans

Use of a long-life fan reduces replacement work. (Design life of fans: 10 years for models of 30 kW or below; 7 years for models of 37 kW or above, at ambient temperature of 40°C)

■ Easy to replace cooling fans

On 5.5-30 kW models, you can easily replace the cooling fan in simple steps, since it is mounted on the upper part of the inverter. On models of 37 kW or above, you can replace it easily from the front side without detaching the inverter from your panel.

To replace the cooling fan, follow the procedures as shown below.

<FRN15F1S-2J>

① Locate the fan cover in the upper part of the inverter.



③ Replacement complete!

② Press the knobs on both sides away from you and remove the fan cover by lifting it up.



② Put back the fan cover.

③ Disconnect the power supply connector and then remove the cooling fan.



① Put the new cooling fan into the slot and connect the power supply connector.

<FRN45F1S-2J>



① Loosen the four screws at the four corners, slide the front cover in the direction of the arrow, and remove the front cover by pulling it toward you.



② Open the keypad case by pulling its handle toward you.

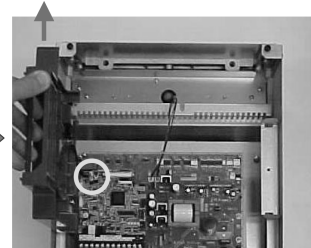

③ Disconnect the connector of the cable connecting the control circuit board to the keypad (shown in O above), tilt the keypad case to 90° against the unit, slide it in the direction of the arrow while keeping this angle, and remove it by pulling it toward you.

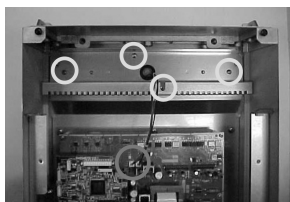

④ Disconnect the connector for switching the fan's power supply and remove the four screws at the four corners (shown in O above).

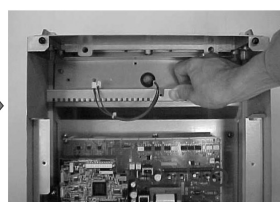

⑤ Grab the fan-mounting board and pull the entire fan block toward you.

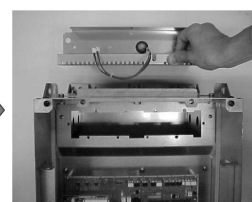

⑥ The fan block is now removed.
After replacing the cooling fan, follow this procedure in the reverse sequence.

■ Cumulative running hours of inverter, capacitor, cooling fan, and motor

FRENIC-Eco series accumulates running hours of the inverter itself, motor (mechanical system), cooling fan, and electrolytic capacitor on the printed circuit board for recording and displaying on the keypad.

These data can be transferred to host equipment via the communications link and used for monitoring and maintenance for mechanical system to increase the reliability of the facility or plant (load).

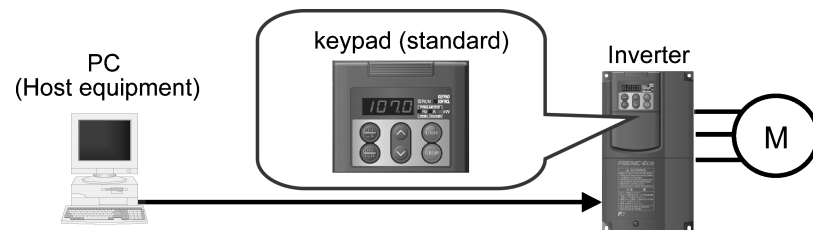

■ Outputting a lifetime early warning signal to the programmable transistor

When either one of the DC link bus capacitor (reservoir capacitor), the electrolytic capacitors on the printed circuit boards, and the cooling fans is nearing the end of its lifetime, a lifetime early warning signal is output.

 Refer to function codes E20 to E22, E24, and E27 in Section 9.2.2 "E codes."

■ Record of the 4 latest alarm history available

You can view alarm codes and their related information up to four latest ones.

 Refer to Section 3.3.7 "Reading alarm information."

■ Protective function against phase loss in input/output

Protection against phase loss in input/output circuits is possible at start-up and during operation.

 Refer to the Protective Functions in Section 8.7 and function code H98 in Section 9.2.5 "H codes."

■ Protective function for grounding fault

Protection is provided for an overcurrent caused by a grounding fault.

 Refer to the Protective Functions in Section 8.7.

■ Protection of motor with PTC thermistor

By connecting the Positive Temperature Coefficient (PTC) thermistor embedded in the motor to the terminal [V2], you can monitor the temperature of the motor, and stop the inverter output before the motor overheats, thereby protecting the motor. You can select the action in the event of an overheat hazard according to the PTC protection level: whether to stop the inverter (alarm stop) or to turn ON the alarm output signal on the programmed terminal.

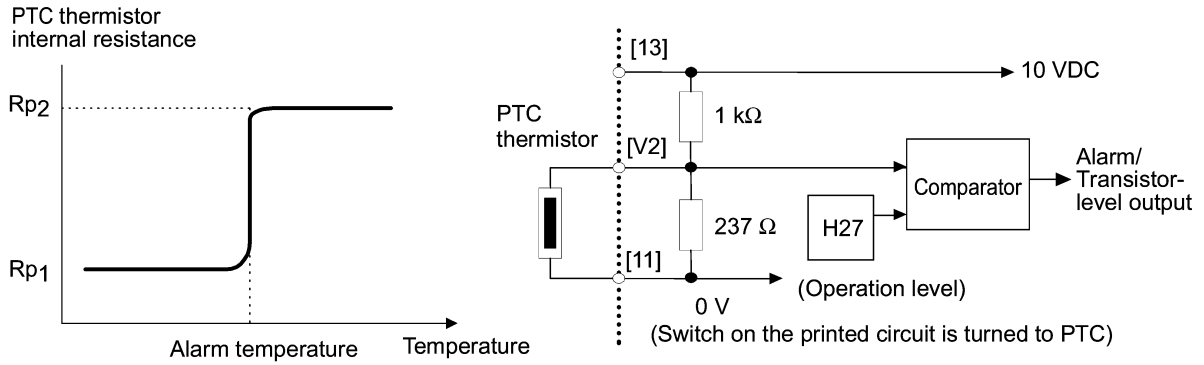

 Refer to function codes F10 to F12 in Section 9.2.1 "F codes" and H26 and H27 in Section 9.2.5 "H codes."

Simple operation and wiring

■ Standard keypad capable of operating at a remote site

Using the optional extension cable easily allows local mode operation at a remote site such as on the power system panel or on hand.

The standard keypad has the function code data copying function that allows you to copy data to other inverters. A multi-function keypad (optional) is also available.

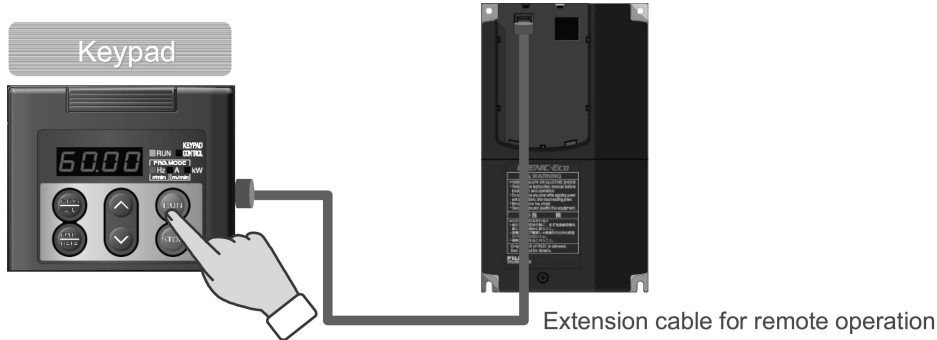

Refer to Chapter 2 "PARTS NAMES AND FUNCTIONS," Section 3.3.8 "Data copying information," Section 6.4.2 "Options for operation and communications," and Section 9.2 "Overview of Function Codes." Refer to function codes E43, E45 to E47 in Section 9.2.2 "E codes."

■ Quick setup function

Using an optional multi-function keypad can define a set of 19 function codes for quick setup. This feature thus allows you to combine only frequently used or important function codes into a customized set to shortcut operation and management.

Refer to Section 3.3.1 "Setting up function codes quickly."

■ Menu mode accessible from the keypad

You can easily access the keypad menu mode including "Data setting," "Data checking," "Drive monitoring," "I/O checking," "Maintenance information," and "Alarm information."

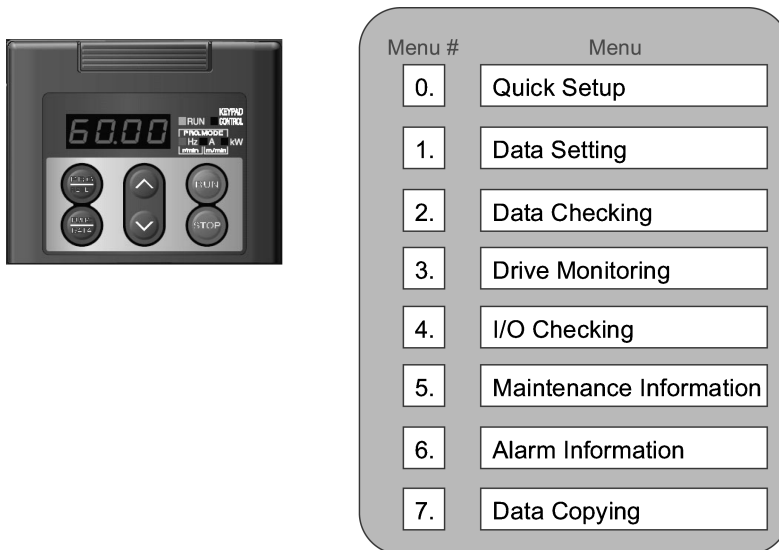

Refer to Section 3.3 "Programming Mode."

■ Multi-function keypad (option)

- A backlit LCD makes it easy to view and note the displayed data.
- Interactive mode of operation simplifies the set-up procedures.
- The keypad can save function code data for up to three inverters.
- The  key switches the mode between Remote and Local with a single touch on it (holding it down for three seconds).
- The keypad allows you to customize the defined set of 19 function codes for quick setup through addition and deletion into your own favorite function code set.
- The keypad allows you to measure the load factor around the clock.
- The keypad is equipped with a communications debug feature.



 Refer to Section 6.4.2 "Options for operation and communications," Section 9.2 "Overview of Function Codes," and function codes E43, E45 to E47 in Section 9.2.2, "E codes."

■ Easy-to-remove/mount front cover and terminal cover

The front cover and the terminal cover of the FRENIC-Eco are easy to remove and mount for setup, checkup and maintenance.

 Refer to Section 2.1 "External View and Allocation of Terminal Blocks" in this manual and the FRENIC-Eco Instruction Manual (INR-SI47-1059-E), Chapter 2 "MOUNTING AND WIRING OF THE INVERTER."

■ LED monitor on the keypad displaying all types of data

You can access and monitor all types of the inverter's operating status data including output frequency, reference frequency, load shaft speed, output current, output voltage, alarm history, and input power, using the keypad regardless the pattern of installation.

 Refer to Chapter 3 "OPERATION USING THE KEYPAD."

Global products

FRENIC-Eco series of inverters are designed for use in global market and to comply with the global standards listed below.

- **All standard models comply with the EC Directive (CE marking), UL standards and Canadian standards (cUL certification).**

All standard FRENIC-Eco inverters comply with European and North American/Canadian standards, enabling standardization of the specifications for machines and equipment used at home and abroad.

- **If the model with built-in EMC filter is used, the model conforms to the European EMC Directive.**

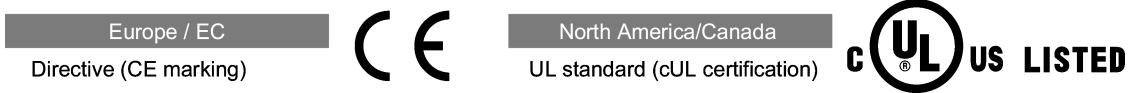

- **Enhanced network support**

With an optional card, the inverter extends its conformity with various world-standard of open bus protocols such as DeviceNet, PROFIBUS-DP, LonWorks network, Modbus Plus or CC-Link.

A standard RS-485 communications port (compatible to Modbus RTU protocol, shared with a keypad) is a built-in feature. With an additional RS-485 communications card (optional), up to two ports are available.

Networking allows you to control up to 31 inverters through host equipment such as a PC (personal computer) and PLC (programmable logic controller.)



 Refer to Chapter 5 "RUNNING THROUGH RS-485 COMMUNICATION," Section 6.4.2 "Options for operation and communications," and Section 9.4.7, "y codes."

Space saving

■ Side-by-side mounting is possible.

When multiple inverter units are installed next to each other inside a panel, the installation space can be minimized. This applies to inverters of 5.5 kW or below operating at ambient temperatures of 40°C or below.

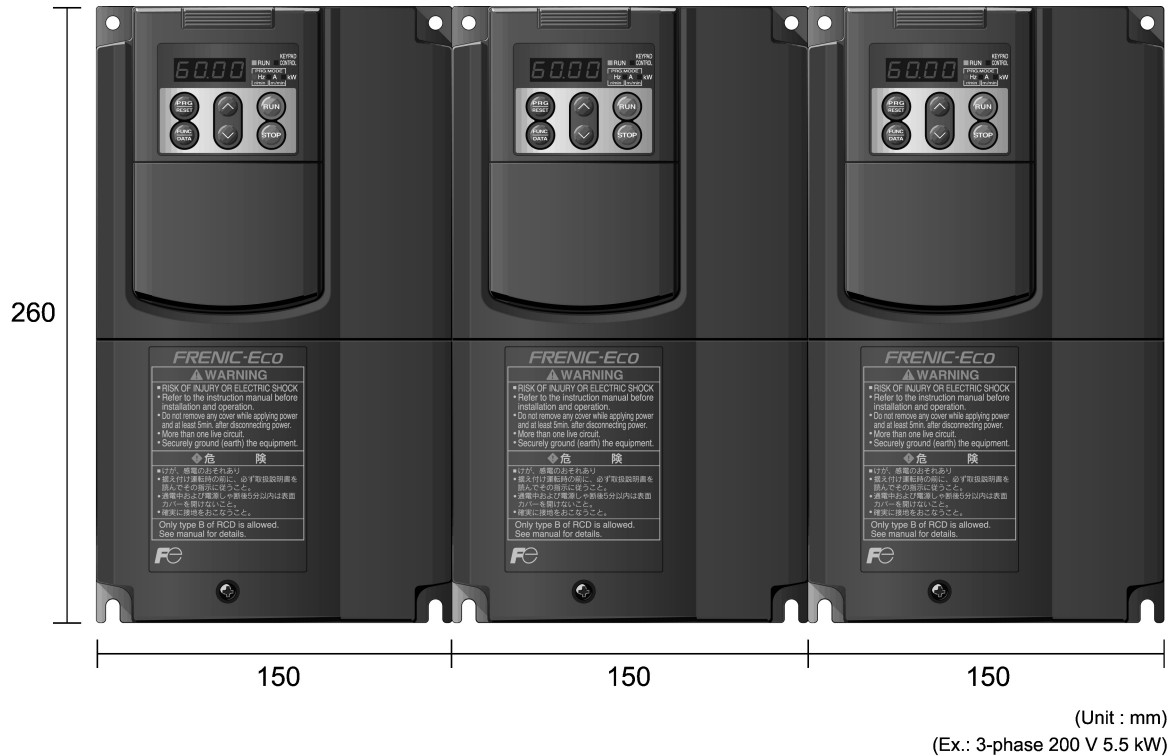



Figure 1.2 Side-by-side Mounting (Example)

The ideal functions to serve a multiplicity of needs

■ Compatible with a wide range of frequency command sources

You can select the optimum frequency command source that matches your machine or equipment via the keypad (\uparrow/\downarrow keys), analog voltage input, analog current input, multistep frequency commands (steps 0 to 7), or the RS-485 communications link.

 Refer to function codes E01 to E05 in Section 9.2.5 "H codes."

■ Switchable sink/source signal input mode

The input mode (sink/source) of the digital input terminals can be switched by means of a slide switch inside the inverter. No engineering change is required in other control equipments including PLC.

 Refer to Section 8.4.1 "Terminal functions."

■ Three transistor switch outputs and a relay output card option available

The three transistor switch outputs enable issuing of motor overload early warning, lifetime early warning and other information signals when the inverter is running. In addition, using the optional relay output card OPC-F1-RY can convert these outputs to three pairs of transfer relay contact outputs [Y1A/Y1B/Y1C], [Y2A/Y2B/Y2C] and [Y3A/Y3B/Y3C], which can be used in the same manner as the conventional relay contact output [30A/B/C].

 Refer to function codes E20 to E22, E24, and E27 in Section 9.2.2 "E codes" in this manual and the Relay Output Card "OPC-F1-RY" Instruction Manual (INR-SI47-0873).

■ Maximum frequency - up to 120 Hz

The inverter can be used with equipment that requires a high motor speed. For high-speed applications, you need to ensure beforehand that the inverter can operate normally with the motor.

 Refer to function code F03 in Section 9.2.1 "F codes."

■ Two points can be set for a non-linear V/f pattern.

The addition of an extra point (total: 2 points) for the non-linear V/f pattern, which can be set as desired, improves the FRENIC-Eco's drive capability, because the V/f pattern can be adjusted to match a wider application area. (Maximum frequency: 120 Hz; Base frequency range: 25 Hz and above)

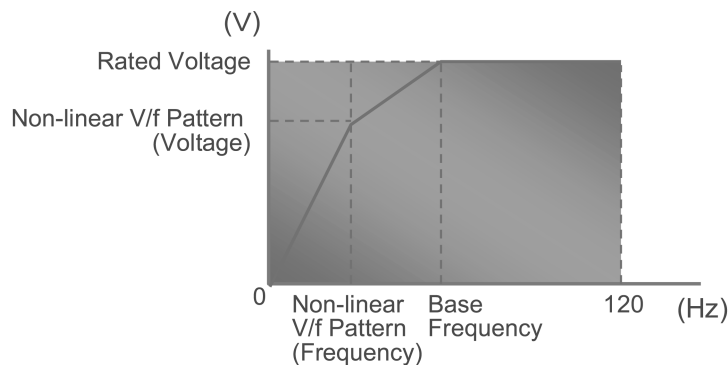

 Refer to Section 4.7 "Drive Command Controller" and function codes F04 and F05 in Section 9.2.1 "F codes."

Flexible through options

■ Function code data copying function

Because the optional multi-function keypad is provided with a built-in copy function, similar to that installed on the inverter as a standard feature, function code data can be easily copied to the second or more inverters without requiring setups individual to the inverter.

 Refer to Section 9.2 "Overview of Function Codes" and Section 3.3.8 "Data copying."

■ Customized set of function code for simplified operation

By using an optional multi-function keypad, you can define your own set of function codes (in addition to those for quick setup) which you will use most frequently, so that you can modify and manage the data for those function codes in simple operation.

 Refer to the Multi-function Keypad Instruction Manual (INR-SI47-0890-E).

■ Inverter loader software (option)

FRENIC Loader is a support tool for FRENIC-Eco/Mini series of inverters to enable a Windows-based PC to remotely control the inverter. The Loader makes it significantly easier to perform data editing and management such as data management, data copying, and real-time tracing. (For connection via a USB port of your PC, an optional USB-RS-485 interface converter is available.)

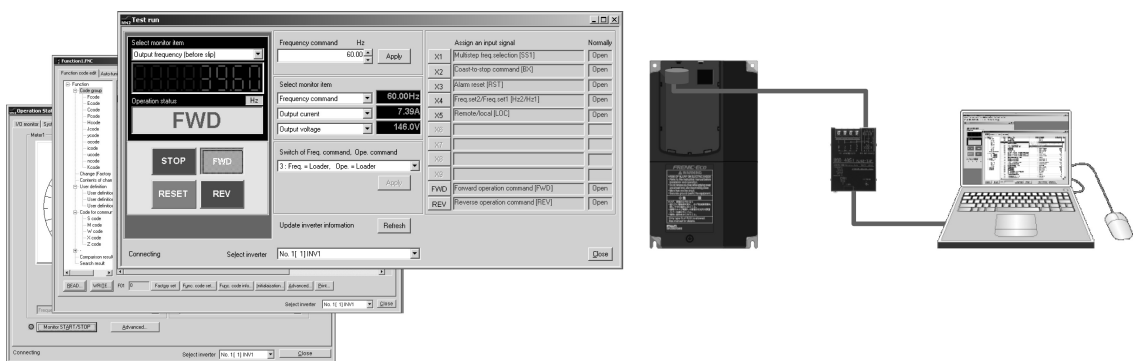

 Refer to Chapter 5 "RUNNING THROUGH RS-485 COMMUNICATION" in this manual and the FRENIC Loader Instruction Manual (INR-SI47-0903-E).

■ Mounting Adapter for External Cooling

A mounting adapter for external cooling (Option for 30 kW or below. Standard for 37 kW or above) cools the inverter outside the panel. It can be easily mounted on the panel.

 Refer to Section 6.4.3 "Extended installation kit options."

1.2 Control System

This section gives you a general overview of inverter control systems and features specific to the FRENIC-Eco series of inverters.

As shown in Figure 1.4, the converter section converts the input commercial power to DC power by means of a full-wave rectifier, which is then used to charge the DC link bus capacitor (reservoir capacitor). The inverter portion modulates the electric energy charged in the DC link bus capacitor by Pulse Width Modulation (PWM) and feeds the output to the motor. (The PWM switching frequency is called the "Carrier Frequency.") The voltage applied to the motor terminals has a waveform shown on the left-hand side ("PWM voltage waveform") of Figure 1.3, consisting of alternating cycles of positive pulse trains and negative pulse trains. The current running through the motor, on the other hand, has a fairly smooth alternating current (AC) waveform shown on the right-hand side ("Current waveform") of Figure 1.3, thanks to the inductance of the motor coil inductance. The control logic section controls the PWM so as to bring this current waveform as close to a sinusoidal waveform as possible.

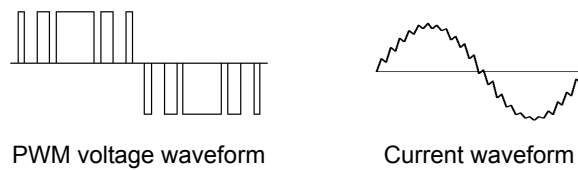



Figure 1.3 Output Voltage and Current Waveform of the Inverter

For the frequency command given in the control logic, the accelerator/decelerator processor calculates the acceleration/deceleration rate required by run/stop control of the motor and transfers the calculated results to the 3-phase voltage processor directly or via the V/f pattern generator whose output drives the PWM block to switch the power gates.

 Refer to Section 4.7 "Drive Command Controller" for details.

The FRENIC-Eco series features simplified magnetic flux estimation integrated in the V/f pattern generator section. This feature automatically adjusts the voltage applied to the motor according to the motor load so as to make the motor generate more stable and higher torque even during low speed operation.

The control logic section, which is the very brain of the inverter, allows you to customize the inverter's driving patterns throughout the function code data settings.

 Refer to Section 4.7 "Drive Command Controller," function codes F04 and F05 in Section 9.2.1 "F codes," and H50 and H51 in Section 9.2.5 "H codes" for details.

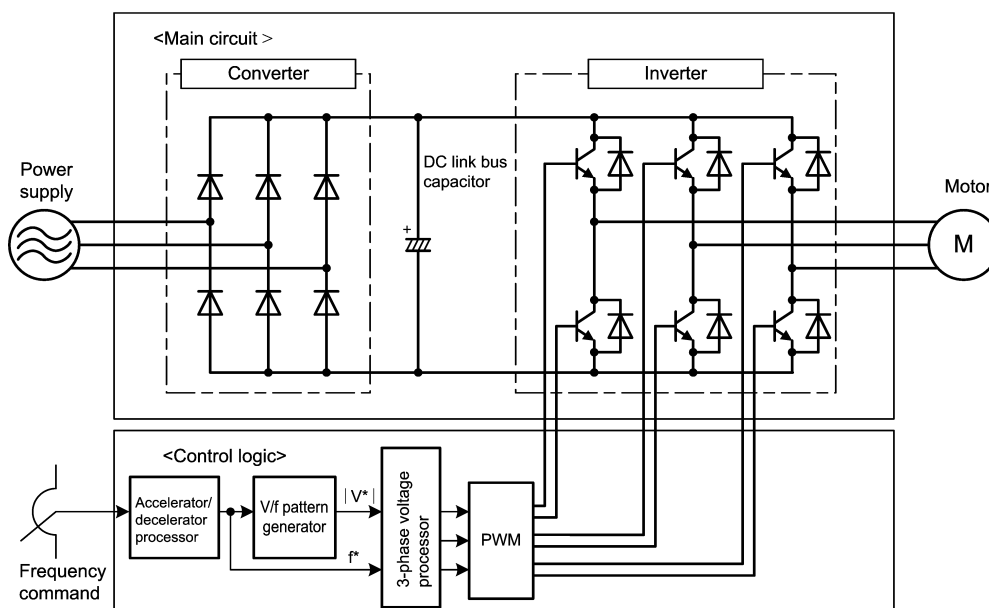

Figure 1.4 Schematic Block Diagram of FRENIC-Eco

1.3 Recommended Configuration

To control a motor with an inverter correctly, you should consider the rated capacity of both the motor and the inverter and ensure that the combination matches the specifications of the machine or system to be used. Refer to Chapter 7 "SELECTING OPTIMAL MOTOR AND INVERTER CAPACITIES" for details.

After selecting the rated capacity, select appropriate peripheral equipment for the inverter, then connect them to the inverter.

 Refer to Chapter 6 "SELECTING PERIPHERAL EQUIPMENT" and Section 8.7 "Connection Diagrams" for details on the selection and connection of peripheral equipment.

Figure 1.5 shows the recommended configuration for an inverter and peripheral equipment.

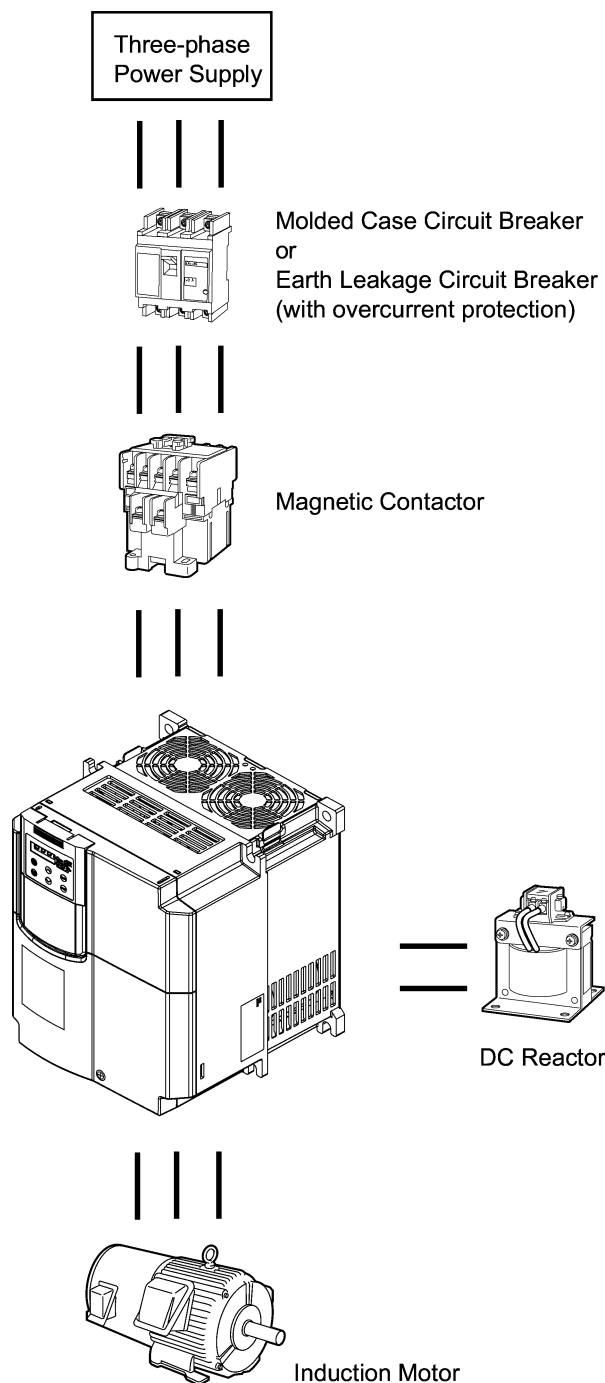

Figure 1.5 Recommended Configuration Diagram

Chapter 2

PARTS NAMES AND FUNCTIONS

This chapter contains external views of the FRENIC-Eco series and an overview of terminal blocks, including a description of the LED monitor, keys and LED indicators on the keypad.

Contents

2.1	External View and Allocation of Terminal Blocks	2-1
2.2	LED Monitor, Keys and LED Indicators on the Keypad.....	2-3

2.1 External View and Allocation of Terminal Blocks

Figure 2.1 shows the external views of the FRENIC-Eco.

(1) External views

■ Standard types

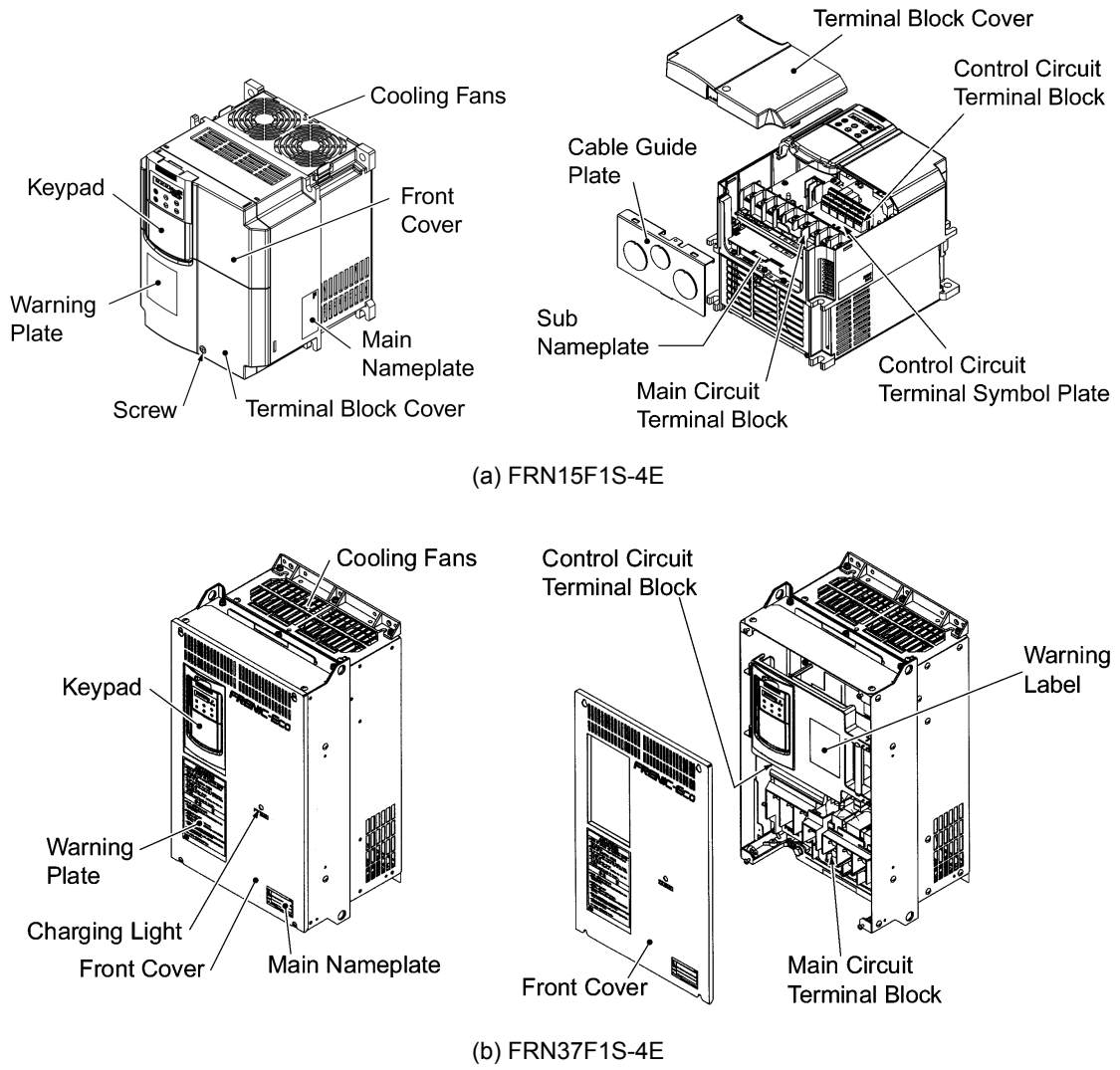
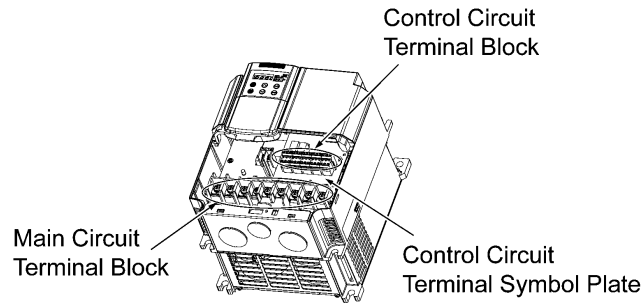
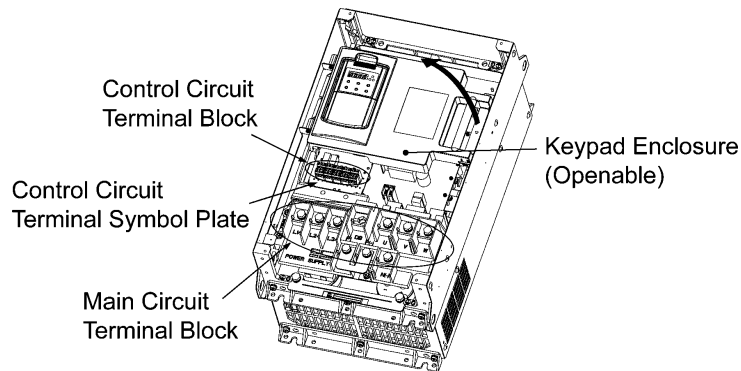

Figure 2.1 External Views of Standard Type Inverters

(2) Terminal block location



(a) FRN15F1S-4E



(b) FRN37F1S-4E

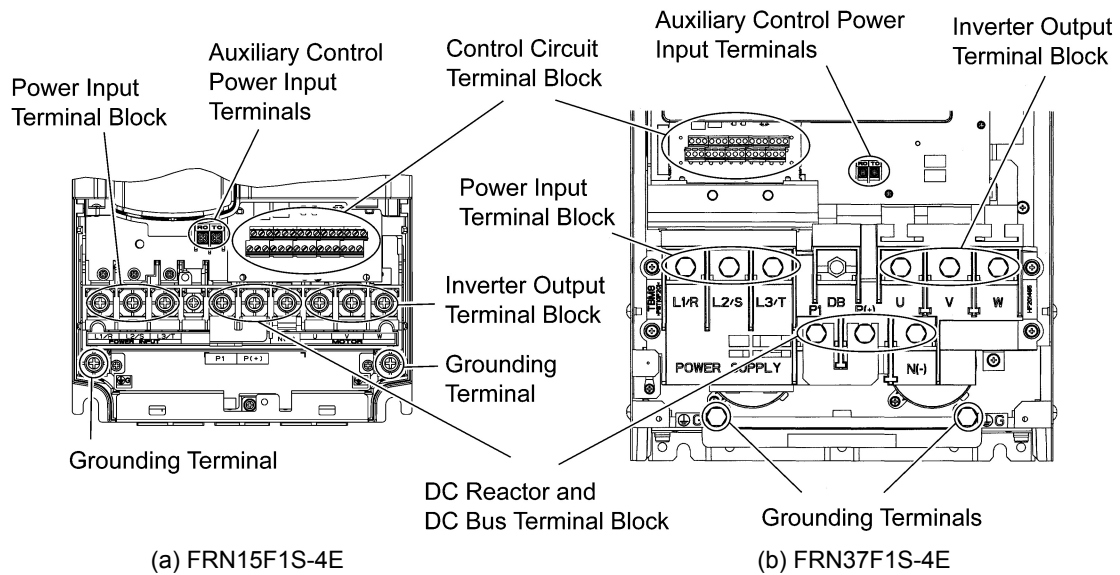

Figure 2.2 Terminal Blocks and Keypad Enclosure Location



(a) FRN15F1S-4E

(b) FRN37F1S-4E

Figure 2.3 Enlarged View of the Terminal Blocks

-  Refer to Chapter 8 "SPECIFICATIONS" for details on terminal functions, arrangement and connection and to Chapter 6, Section 6.2.1 "Recommended wires" when selecting wires.
-  For details on the keys and their functions, refer to Section 2.2 "LED Monitor, Keys and LED Indicators on the Keypad." For details on keying operation and function code setting, refer to Chapter 3 "OPERATION USING THE KEYPAD."

2.2 LED Monitor, Keys and LED Indicators on the Keypad

As shown at the right, the keypad consists of a four-digit LED monitor, six keys, and five LED indicators.

The keypad allows you to run and stop the motor, monitor running status, and switch to the menu mode. In the menu mode, you can set the function code data, monitor I/O signal states, maintenance information, and alarm information.

A multi-function keypad is optionally available.

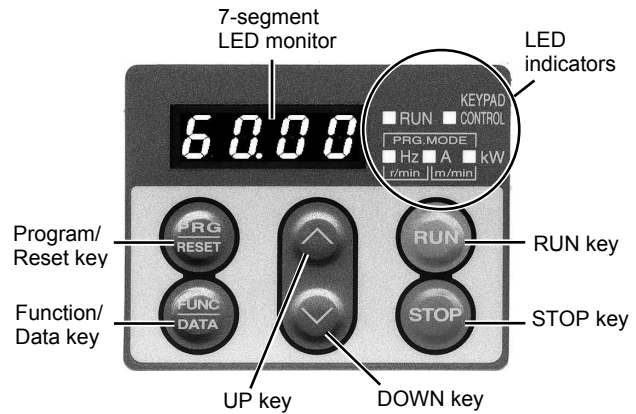

Figure 2.4 Keypad

Table 2.1 Overview of Keypad Functions

Item	LED Monitor, Keys, and LED Indicators	Functions
LED Monitor		<p>Four-digit, 7-segment LED monitor which displays the followings according to the operation modes.</p> <ul style="list-style-type: none"> ■ In Running mode: Running status information (e.g., output frequency, current, and voltage) ■ In Programming mode: Menus, function codes and their data ■ In Alarm mode: Alarm code, which identifies the alarm factor if the protective function is activated.
Operation Keys		<p>Program/Reset key which switches the operation modes of the inverter.</p> <ul style="list-style-type: none"> ■ In Running mode: Pressing this key switches the inverter to Programming mode. ■ In Programming mode: Pressing this key switches the inverter to Running mode. ■ In Alarm mode: Pressing this key after removing the alarm factor will switch the inverter to Running mode.
		<p>Function/Data key which switches the operation you want to do in each mode as follows:</p> <ul style="list-style-type: none"> ■ In Running mode: Pressing this key switches the information to be displayed concerning the status of the inverter (output frequency (Hz), output current (A), output voltage (V), etc.). ■ In Programming mode: Pressing this key displays the function code and sets the data entered with and . ■ In Alarm mode: Pressing this key displays the details of the problem indicated by the alarm code that has come up on the LED monitor.
		RUN key. Press this key to run the motor.
		STOP key. Press this key to stop the motor.
		UP and DOWN keys. Press these keys to select the setting items and change the function code data displayed on the LED monitor.
LED Indicators	RUN LED	Lights when any run command to the inverter is active.
	KEYPAD CONTROL LED	Lights when the inverter is ready to run with a run command entered by the key. In Programming and Alarm modes, you cannot run the inverter even if the indicator lights.
	Unit and mode expression by the three LED indicators	<p>The lower 3 LED indicators identify the unit of numeral displayed on the LED monitor in Running mode by combination of lit and unlit states of them.</p> <p>Unit: kW, A, Hz, r/min and m/min</p> <p>Refer to Chapter 3, Section 3.2.1 "Monitoring the running status" for details.</p> <p>While the inverter is in Programming mode, two LEDs at both ends of the lower indicators light.</p> <p>In Programming mode: ■Hz □A ■kW</p>

■ LED monitor

In Running mode, the LED monitor displays running status information (output frequency, current or voltage); in Programming mode, it displays menus, function codes and their data; and in Alarm mode, it displays an alarm code which identifies the alarm factor if the protective function is activated.

If one of LED4 through LED1 is blinking, it means that the cursor is at this digit, allowing you to change it.

If the decimal point of LED1 is blinking, it means that the currently displayed data is a value of the PID process command, not the frequency data usually displayed.

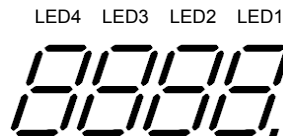

Figure 2.5 7-Segment LED Monitor

Table 2.2 Alphanumeric Characters on the LED Monitor

Character	7-segment	Character	7-segment	Character	7-segment	Character	7-segment
0		9		i		r	
1		A		J		S	
2		b		K		T	
3		C		L		u	
4		d		M		V	
5		E		n		W	
6		F		o		X	
7		G		P		y	
8		H		q		Z	
Special characters and symbols (numbers with decimal point, minus and underscore)							
0. - 9.		-		_			

■ Simultaneous keying

Simultaneous keying means pressing two keys at the same time. The FRENIC-Eco supports simultaneous keying as listed below. The simultaneous keying operation is expressed by a "+" letter between the keys throughout this manual.

(For example, the expression " + keys" stands for pressing the key while holding down the key.)

Table 2.3 Simultaneous Keying

Operation mode	Simultaneous keying	Used to:
Programming mode	+ keys	Change certain function code data. (Refer to codes F00, H03, and H97 in Chapter 9 "FUNCTION CODES.")
	+ keys	
Alarm mode	+ keys	Switch to Programming mode without resetting alarms currently occurred.

Chapter 3

OPERATION USING THE KEYPAD

This chapter describes inverter operation using the keypad. The inverter features three operation modes (Running, Programming and Alarm modes) which enable you to run and stop the motor, monitor running status, set function code data, display running information required for maintenance, and display alarm data.

The keypad is available in two types: standard keypad and optional multi-function keypad. For the instructions on how to operate the multi-function keypad, refer to the "Multi-function Keypad Instruction Manual" (INR-SI47-0890-E).

Contents

3.1	Overview of Operation Modes.....	3-1
3.2	Running Mode.....	3-3
3.2.1	Monitoring the running status.....	3-3
3.2.2	Setting up frequency and PID process commands.....	3-4
3.2.3	Running/stopping the motor.....	3-7
3.3	Programming Mode.....	3-11
3.3.1	Setting up basic function codes quickly -- Menu #0 "Quick Setup" --.....	3-13
3.3.2	Setting up function codes -- Menu #1 "Data Setting" --.....	3-17
3.3.3	Checking changed function codes -- Menu #2 "Data Checking" --.....	3-18
3.3.4	Monitoring the running status -- Menu #3 "Drive Monitoring" --.....	3-19
3.3.5	Checking I/O signal status -- Menu #4 "I/O Checking" --.....	3-22
3.3.6	Reading maintenance information -- Menu #5 "Maintenance Information" --.....	3-26
3.3.7	Reading alarm information -- Menu #6 "Alarm Information" --.....	3-29
3.3.8	Data copying information -- Menu #7 "Data Copying" --.....	3-31
3.4	Alarm Mode.....	3-35
3.4.1	Releasing the alarm and switching to Running mode.....	3-35
3.4.2	Displaying the alarm history.....	3-35
3.4.3	Displaying the status of inverter at the time of alarm.....	3-35
3.4.4	Switching to Programming mode.....	3-35

3.1 Overview of Operation Modes

FRENIC-Eco features the following three operation modes:

- **Running mode** : This mode allows you to enter run/stop commands in regular operation. You can also monitor the running status in real time.
- **Programming mode** : This mode allows you to set function code data and check a variety of information relating to the inverter status and maintenance.
- **Alarm mode** : If an alarm condition arises, the inverter automatically enters the Alarm mode. In this mode, you can view the corresponding alarm code* and its related information on the LED monitor.

* Alarm code: Indicates the cause of the alarm condition that has triggered a protective function. For details, refer to Chapter 8, Section 8.7 "Protective Functions."

Figure 3.1 shows the status transition of the inverter between these three operation modes.

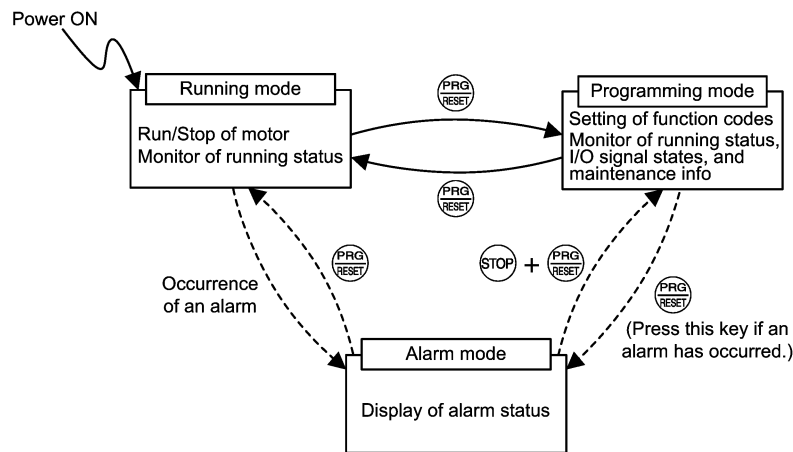
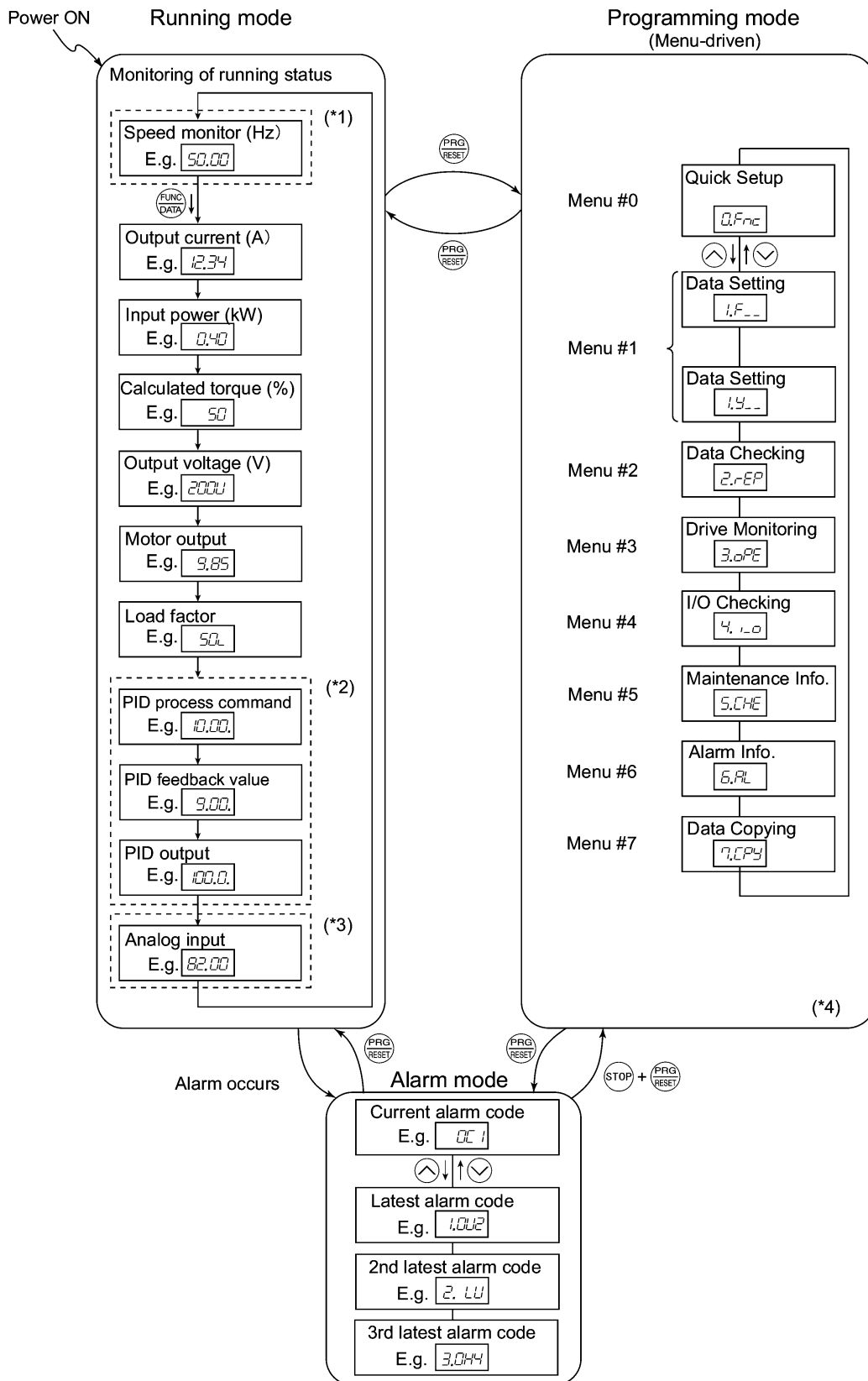

Figure 3.1 Status Transition between Operation Modes

Figure 3.2 illustrates the transition of the LED monitor screen during Running mode, the transition between menu items in Programming mode, and the transition between alarm codes at different occurrences in Alarm mode.



- *1 In speed monitor, you can have any of the following displayed according to the setting of function code E48: Output frequency (Hz), Motor speed (r/min), Load shaft speed (r/min), and Speed (%).
- *2 Applicable only when PID control is active. (J01 = 1 or 2)
- *3 Applicable only when the analog signal input monitor is assigned to any terminals [12], [C1], or [V2] by E61, E62 or E63 (= 20).
- *4 Applicable only when the full-menu mode is active. (E52 = 2)

Figure 3.2 Transition between Basic Display Frames by Operation Mode

3.2 Running Mode

When the inverter is turned on, it automatically enters Running mode. In this mode, you can:

- (1) Monitor the running status (e.g., output frequency, output current),
- (2) Set up the frequency command and others, and
- (3) Run/stop the motor.

3.2.1 Monitoring the running status



In Running mode, the eleven items listed below can be monitored. Immediately after the inverter is turned on, the monitor item specified by function code E43 is displayed. Press the  key to switch between monitor items. For details of switching the monitor item by using the  key, refer to "Monitoring of Running Status" in Figure 3.2 Transition between Basic Display Frames by Operation Mode.

Table 3.1 Monitoring Items

Monitor Items	Display Sample on the LED monitor *1	LED indicator ■: on, □: off	Unit	Meaning of Displayed Value	Function Code E43
Speed monitor	Function code E48 specifies what to be displayed on the LED monitor and LED indicators.				0
Output frequency	50.00	■Hz □A □kW	Hz	Frequency actually being output	(E48 = 0)
Motor speed	1500	■Hz ■A □kW	r/min	Output frequency (Hz) × $\frac{120}{P01}$	(E48 = 3)
Load shaft speed	300.0	■Hz ■A □kW	r/min	Output frequency (Hz) × E50	(E48 = 4)
Speed (%)	50.0	□Hz □A □kW	%	$\frac{\text{Output frequency}}{\text{Maximum frequency}} \times 100$	(E48 = 7)
Output current	12.34	□Hz ■A □kW	A	Current output from the inverter in RMS	3
Output voltage *2	200.0	□Hz □A □kW	V	Voltage output from the inverter in RMS	4
Calculated output torque	50	□Hz □A □kW	%	Motor output torque in % (Calculated value)	8
Input power	10.25	□Hz □A ■kW	kW	Input power to the inverter	9
PID process command *3, *4	10.00	□Hz □A □kW	—	PID process command/feedback value transformed to that of virtual physical value of the object to be controlled (e.g. temperature)	10
PID feedback value *3, *5	9.00	□Hz □A □kW	—		12
PID output *3, *4	100.0	□Hz □A □kW	%	PID output in % as the maximum frequency (F03) being at 100%	14
Load factor *6	50	□Hz □A □kW	%	Load factor of the motor in % as the rated output being at 100%	15
Motor output *7	9.85	□Hz □A ■kW	kW	Motor output in kW	16
Analog input *8	82.00	□Hz □A □kW	—	Analog input signal to the inverter, transformed by E40 and E41 Refer to the function codes E40 and E41 for details.	17

- *1 A value exceeding 9999 cannot be displayed on the 4-digit LED monitor screen, so “L J” (7-segment letters) appear instead.
- *2 For displaying an output voltage on the LED monitor, the 7-segment letter ‘V’ is used in the lowest digit as an alternative expression of the unit of the V (volt).
- *3 These PID-related items appear only when the inverter PID-controls the motor according to a PID process command specified by the function code J01 (= 1 or 2).
- *4 When the LED monitor displays a PID process command or its output amount, the dot (decimal point) attached to the lowest digit of the 7-segment letter blinks.
- *5 When the LED monitor displays a PID feedback value, the dot (decimal point) attached to the lowest digit of the 7-segment letter lights.
- *6 For displaying a load factor on the LED monitor, the 7-segment letter ‘L’ is used in the lowest digit as an alternative expression of the unit of %.
- *7 When the LED monitor displays the motor output, the unit LED indicator "kW" blinks.
- *8 Analog input monitoring becomes active only when any data of the function codes E61, E62 and E63 is effective (= 20) to define a terminal function.

3.2.2 Setting up frequency and PID process commands

You can set up the desired frequency and PID process commands by using \triangle and ∇ keys on the keypad. It is also possible to set up the frequency command as load shaft speed, motor speed or speed (%) by setting function code E48.

■ Setting up a frequency command

Using \triangle and ∇ keys (Factory default)

- (1) Set function code F01 to "0: Enable \triangle / ∇ keys on keypad." This can be done only when the inverter is in Running mode.
- (2) Press the \triangle / ∇ key to display the current reference frequency. The lowest digit will blink.
- (3) If you need to change the frequency command, press the \triangle / ∇ key again. The new setting will be automatically saved into the inverter's internal memory and retained even when the power is off. When the power is turned on next time, the setting will be used as an initial reference frequency.



- The frequency command can be saved either automatically as mentioned above or by pressing the FUNC DATA key. You can choose either way using function code E64.
- If you have set function code F01 to "0: Enable \triangle / ∇ keys on keypad" but have selected a frequency command source other than frequency command 1 (i.e., frequency command 2, frequency command via communication, or multistep frequency command), then the \triangle and ∇ keys are disabled to change the current frequency command even in Running mode. Pressing either of these keys just displays the current reference frequency.
- When you start specifying or changing the frequency command or any other parameter with the \triangle / ∇ key, the lowest digit on the display blinks and starts changing. As you are holding down the key, blinking will gradually move to the upper digit places and the upper digits will be changeable.
- If you press the \triangle / ∇ key once and then hold down the PRG RESET key for more than 1 second after the lowest digit starts blinking, blinking will move to the next upper digit place to allow you to change the value of that digit (cursor movement). This way you can easily change the values of the higher digits.
- By setting function code C30 to "0: Enable \triangle / ∇ keys on keypad" and selecting frequency command 2, you can also specify or change the frequency command in the same manner using the \triangle / ∇ key

You can set up a frequency command not only with the frequency (Hz) but also with other menu items (Motor speed, load shaft speed, and speed (%)) depending on the setting of function code E48 (= 3, 4, or 7) "Speed monitor items" as shown in Table 3.1.

■ Make setting under PID control

To enable PID control, you need to set function code J01 to 1 or 2.

Under the PID control, the items that can be set or checked with \triangleleft and \triangleright keys are different from those under regular frequency control, depending upon the current LED monitor setting. If the LED monitor is set to the speed monitor (E43 = 0), you can access manual speed commands (Frequency command) with \triangleleft and \triangleright keys; if it is set to any other, you can access the PID process command with those keys.



Refer to Chapter 4, Section 4.8, "PID Frequency Command Generator" for details on the PID control.

Setting the PID process command with \triangleleft and \triangleright keys

- (1) Set function code J02 to "0: Enable \triangleleft / \triangleright keys on keypad."
- (2) Set the LED monitor to something other than the speed monitor (E43=0) when the inverter is in Running mode. When the keypad is in Programming or Alarm mode, you cannot modify the PID process command with the \triangleleft / \triangleright key. To enable the PID process command to be modified with the \triangleleft / \triangleright key, first switch to Running mode.
- (3) Press the \triangleleft / \triangleright key to have the PID process command displayed. The lowest digit will blink on the LED monitor.
- (4) To change the PID process command, press the \triangleleft / \triangleright key again. The PID process command you have specified will be automatically saved into the inverter's internal memory. It is kept there even if you temporarily switch to another means of specifying the PID process command and then go back to the means of specifying the PID process command via the keypad. Also, it is kept there even while the inverter is powered off, and will be used as the initial PID process command next time the inverter is powered on.



- Even if multistep frequency is selected as the PID process command ((SS4) = ON), you still can set the process command using the keypad.
- When function code J02 is set to any value other than 0, pressing the \triangleleft / \triangleright key displays, on the 7-segment LED monitor, the PID command currently selected, while you cannot change the setting.
- On the 7-segment LED monitor, the decimal point of the lowest digit is used to characterize what is displayed. The decimal point of the lowest digit blinks when a PID process command is displayed; the decimal point lights when a PID feedback value is displayed.

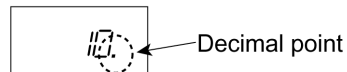

Table 3.2 PID Process Command Manually Set with \triangleleft / \triangleright Key and Requirements

PID Control (Selection) J01	PID Control (Remote Process Command) J02	LED Monitor E43	Multistep Frequency (SS4)	With the \triangleleft / \triangleright key
1 or 2	0	Other than 0	ON or OFF	PID process command <u>by keypad</u>
	Other than 0			PID process command <u>currently selected</u>

Setting up the frequency command with \wedge and \vee keys under PID control

When function code F01 is set to "0" (Enable \wedge / \vee keys on keypad) and frequency command 1 is selected as a manual speed command (that is, disabling the frequency setting command via communications link and multistep frequency command), switching the LED monitor to the speed monitor in Running mode enables you to modify the frequency command with the \wedge / \vee keys.

In Programming or Alarm mode, the \wedge / \vee keys are disabled to modify the frequency command. You need to switch to Running mode.

Table 3.3 lists the combinations of the commands and the figure illustrates how the manual speed command ① entered via the keypad is translated to the final frequency command ②.



The setting procedure is the same as that for setting of a usual frequency command.

Table 3.3 Manual Speed (Frequency) Command Set with \wedge / \vee Keys and Requirements

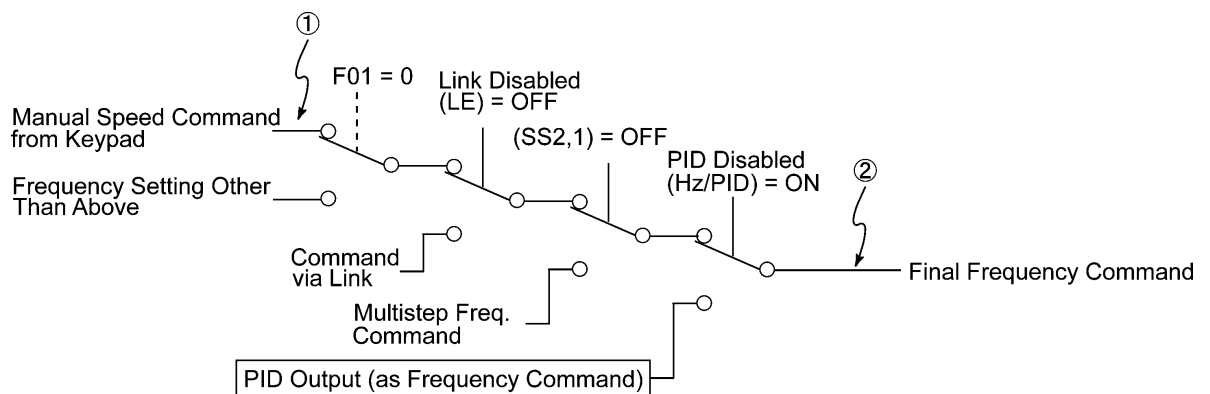
PID Control (Selection) J01	LED Monitor E43	Frequency Command 1 F01	Multistep Frequency (SS2)	Multistep Frequency (SS1)	Link Operation Selection (LE)	Disable PID Control (Hz/PID)	Pressing \wedge / \vee keys controls:	
1 or 2	0	0	OFF	OFF	OFF	OFF (PID enabled)	PID output (as final frequency command)	
						ON (PID disabled)	Manual speed (frequency) command set by keypad	
		Other than the above					OFF (PID enabled)	PID output (as final frequency command)
							ON (PID disabled)	Manual speed (frequency) command currently selected



3.2.3 Running/stopping the motor

By factory default, pressing the  key starts running the motor in the forward direction and pressing the  key decelerates the motor to stop. The  key is enabled only in Running mode.

The motor rotational direction can be selected by changing the setting of function code F02.

For the optional multi-function keypad, see page 3-10.



■ Operational relationship between function code F02 (Run command) and key



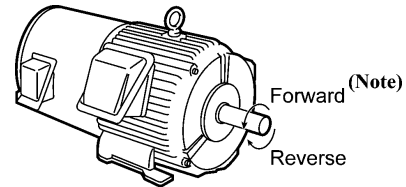

Table 3.4 lists the relationship between function code F02 settings and the  key, which determines the motor rotational direction.

Table 3.4 Motor Rotational Direction Specified by F02

Data for F02	Pressing the  key runs the motor:
0	In the direction commanded by terminal [FWD] or [REV]
1	 key disabled (The motor is driven by terminal command [FWD] or [REV].)
2	In the forward direction
3	In the reverse direction



(Note) The rotational direction of IEC-compliant motors is opposite to that of the motor shown here.

 For the details on operations with function code F02, refer to Chapter 9 “FUNCTION CODES.”

 **Note** When the keypad is in use for specifying the frequency settings or driving the motor, do not disconnect the keypad from the inverter when the motor is running. Doing so may stop the inverter.

■ Remote and local modes













The inverter can be operated either in remote or local mode. In remote mode that applies to ordinary operation, the inverter is driven under the control of the data settings stored in the inverter, whereas in local mode that applies to maintenance operation, it is separated from the control system and is driven manually under the control of the keypad.

- Remote mode: The run and frequency commands are selected by source switching signals including function codes, run command 2/1 signals, and communications link operation signal.
- Local mode: The command source is the keypad, regardless of the settings specified by function codes. The keypad takes precedence over the settings specified by run command 2/1 signals or communications link operation signal.

Run commands from the keypad in local mode

The table below shows the input procedures of run commands from the keypad in local mode.

Table 3.5 Run Commands from the Keypad in Local Mode

When Data for F02 (Run command) is :	Input Procedures of Run Commands from Keypad
0: Enable  /  keys on keypad (Motor rotational direction from digital terminals [FWD]/[REV])	Pressing the  key runs the motor in the direction specified by command (FWD) or (REV) assigned to terminal [FWD] or [REV], respectively. Pressing the  key stops the motor.
1: Enable terminal command (FWD)/(REV)	Pressing the  key runs the motor in the forward direction only. Pressing the  key stops the motor.
2: Enable  /  keys on keypad (Forward)	No specification of the motor rotational direction is required.
3: Enable  /  keys on keypad (Reverse)	Pressing the  key runs the motor in the reverse direction only. Pressing the  key stops the motor. No specification of the motor rotational direction is required.

Switching between remote and local modes

The remote and local modes can be switched by a digital input signal provided from the outside of the inverter.

To enable the switching, you need to assign (LOC) as a digital input signal to any of terminals [X1] to [X5] by setting "35" to any of E01 to E05, E98 and E99. By factory default, (LOC) is assigned to [X5].

Switching from remote to local mode automatically inherits the frequency settings used in remote mode. If the motor is running at the time of the switching from remote to local, the run command is automatically turned on so that all the necessary data settings will be carried over. If, however, there is a discrepancy between the settings used in remote mode and ones made on the keypad (e.g., switching from the reverse rotation in remote mode to the forward rotation only in local mode), the inverter automatically stops.

The transition paths between remote and local modes depend on the current mode and the value (on/off) of (LOC), as shown in the status transition diagram given below. Also, refer to Table 3.5 "Run Commands from the Keypad in Local Mode" for details.

 For further details on how to specify run and frequency commands in remote and local modes, refer to Chapter 4, Section 4.3, "Drive Command Generator."

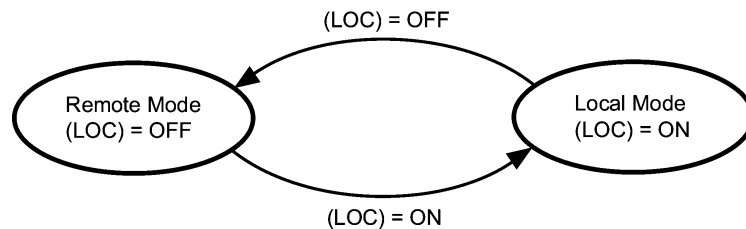

Transition between Remote and Local Modes by (LOC)



Switching between Remote and Local Modes on Optional Multi-function Keypad

The multi-function keypad has a remote/local toggle key . Holding down the key for at least one second toggles between remote and local modes when the digital input signal (LOC) is off.

When the (LOC) is on, the key is disabled.

The figure below shows the switching by the key and (LOC).

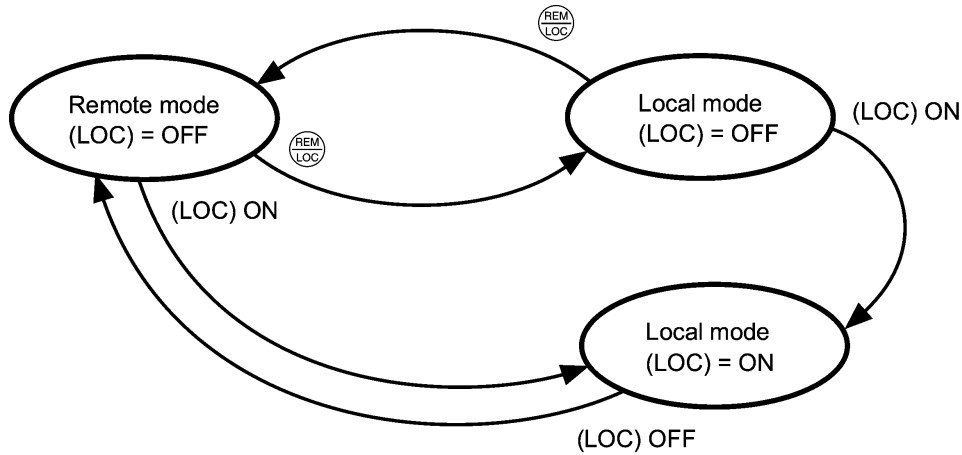

3.3 Programming Mode

The Programming mode provides you with these functions--setting and checking function code data, monitoring maintenance information and checking input/output (I/O) signal status. The functions can be easily selected with the menu-driven system. Table 3.7 lists menus available in Programming mode. The leftmost digit (numerals) of each letter string on the LED monitor indicates the corresponding menu number and the remaining three digits indicate the menu contents.

When the inverter enters Programming mode from the second time on, the menu selected last in Programming mode will be displayed.

Table 3.7 Menus Available in Programming Mode

Menu #	Menu	LED monitor shows:	Main functions	Refer to:	
0	"Quick Setup"	0.FrC	Displays only basic function codes to customize the inverter operation.	Section 3.3.1	
1	"Data Setting"	1.F--	F codes (Fundamental functions)	Selecting each of these function codes enables its data to be displayed/changed.	Section 3.3.2
		1.E--	E codes (Extension terminal functions)		
		1.C--	C codes (Control functions of frequency)		
		1.P--	P codes (Motor parameters)		
		1.H--	H codes (High performance functions)		
		1.W--	J codes (Application functions)		
		1.Y--	y codes (Link functions)		
		1.O--	o codes (Optional function) (Note)		
2	"Data Checking"	2.rEP	Displays only function codes that have been changed from their factory defaults. You can refer to or change those function code data.	Section 3.3.3	
3	"Drive Monitoring"	3.oPE	Displays the running information required for maintenance or test running.	Section 3.3.4	
4	"I/O Checking"	4.I.O	Displays external interface information.	Section 3.3.5	
5	"Maintenance Information"	5.rHE	Displays maintenance information including cumulative run time.	Section 3.3.6	
6	"Alarm Information"	6.rAL	Displays the latest four alarm codes. You can refer to the running information at the time when the alarm occurred.	Section 3.3.7	
7	"Data Copying"	7.rPY	Allows you to read or write function code data, as well as verifying it.	Section 3.3.8	

(Note) An o code appears only when any option is mounted on the inverter. For details, refer to the instruction manual of the corresponding option.

 Using the multi-function keypad (option) provides the "Alarm Cause," "Load Factor Measurement," "User Setting," and "Communication Debugging" in addition to the menus listed above.

For details, refer to the "Multi-function Keypad Instruction Manual" (INR-SI47-0890-E).

Figure 3.3 illustrates the menu-driven function code system in Programming mode.

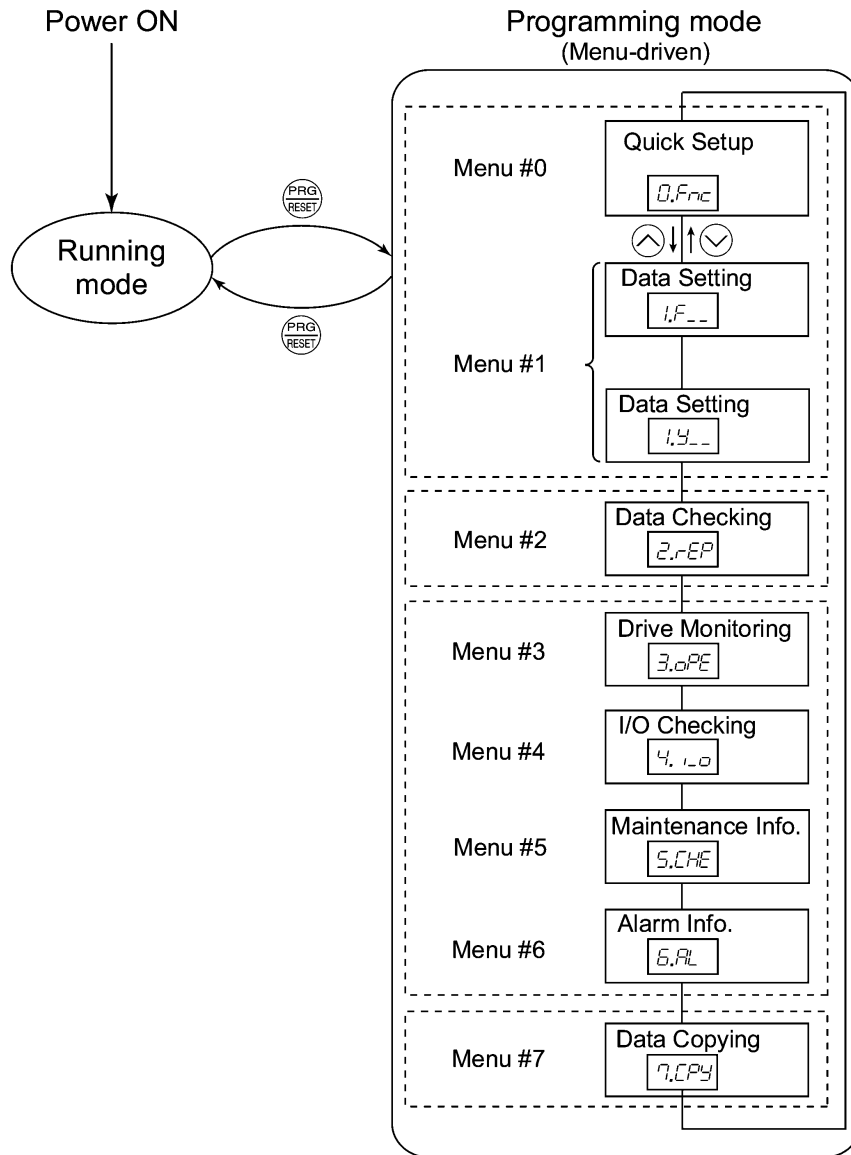





Figure 3.3 Menu Transition in the Programming Mode

■ Selecting menus to display

The menu-driven system has a limiter function (specified by function code E52) that limits menus to be displayed for the purpose of simple operation. The factory default (E52 = 0) is to display only three menus--Menu #0 "Quick Setup," Menu #1 "Data Setting" and Menu #7 "Data Copying," allowing no switching to any other menu.

Table 3.8 Keypad Display Mode Selection – Function Code E52

Data for E52	Mode	Menus selectable
0	Function code data editing mode (factory default)	Menu #0 "Quick Setup" Menu #1 "Data Setting" Menu #7 "Data Copying"
1	Function code data check mode	Menu #2 "Data Checking" Menu #7 "Data Copying"
2	Full-menu mode	Menu #0 through #7

 Pressing the  /  key will cycle through the menu. With the  key, you can select the desired menu item. Once the entire menu has been cycled through, the display will return to the first menu item.

3.3.1 Setting up basic function codes quickly

-- Menu #0 "Quick Setup" --

Menu #0 "Quick Setup" in Programming mode allows you to quickly display and set up a basic set of function codes specified in Chapter 9, Section 9.1, "Function Code Tables."

To use Menu #0 "Quick Setup," you need to set function code E52 to "0" (Function code data editing mode) or "2" (Full-menu mode).

The predefined set of function codes that are subject to quick setup are held in the inverter.

Listed below are the function codes (including those not subject to quick setup) available on the FRENIC-Eco. A function code is displayed on the LED monitor on the keypad in the following format:

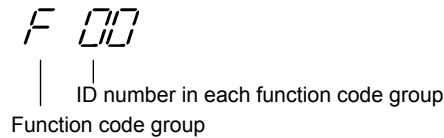

Table 3.9 Function Codes Available on FRENIC-Eco

Function Code Group	Function Codes	Function	Description
F codes	F00 to F44	Fundamental functions	Functions concerning basic motor running
E codes	E01 to E99	Extension terminal functions	Functions concerning the assignment of control circuit terminals Functions concerning the display of the LED monitor
C codes	C01 to C53	Control functions of frequency	Functions associated with frequency settings
P codes	P01 to P99	Motor parameters	Functions for setting up characteristics parameters (such as capacity) of the motor
H codes	H03 to H98	High performance functions	Highly added-value functions Functions for sophisticated control
J codes	J01 to J22	Application functions	Functions for applications such as PID control
y codes	y01 to y99	Link functions	Functions for controlling communication
o codes	o27 to o59	Optional functions	Functions for options (Note)

(Note) The o codes are displayed only when the corresponding option is mounted. For details of the o codes, refer to the Instruction Manual for the corresponding option.



For the list of function codes subject to quick setup and their descriptions, refer to Chapter 9, Section 9.1 "Function Code Tables."

■ **Function codes requiring simultaneous keying**

To modify the data for function code F00 (data protection), H03 (data initialization), or H97 (clear alarm data), simultaneous keying is needed, involving the $\text{STOP} + \text{^}$ keys or $\text{STOP} + \text{v}$ keys.

■ **Changing, validating, and saving function code data when the inverter is running**

Some function code data can be changed while the inverter is running, whereas others cannot. Further, depending on the function code, modifications may or may not validate immediately. For details, refer to the "Change when running" column in Chapter 9, Section 9.1 "Function Code Tables."



For details of function codes, refer to Chapter 9, Section 9.1 "Function Code Tables."

Figure 3.4 shows the menu transition in Menu #1 "Quick Setup."

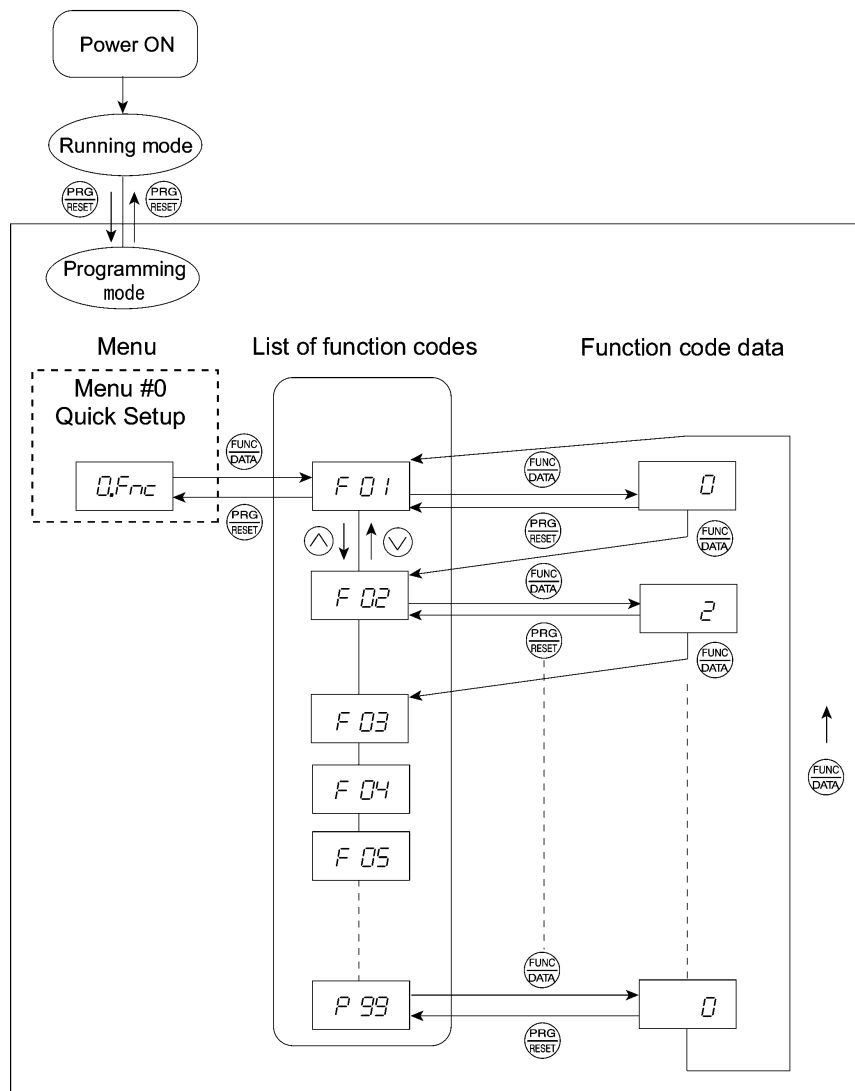

Figure 3.4 Menu Transition in Menu #0 "Quick Setup"



Through a multi-function keypad, you can add or delete function codes that are subject to Quick Setup. For details, refer to the "Multi-function Keypad Instruction Manual" (INR-SI47-0890-E).

Once you have added or deleted function codes for Quick Setup through a multi-function keypad, they will remain valid even after you switch to a standard keypad. To restore the function code settings subject to Quick Setup to their factory defaults, initialize the whole data using function code H03 (data = 1).

Basic key operation

This section gives a description of the basic key operation, following the example of the function code data changing procedure shown in Figure 3.5.

This example shows you how to change function code F01 data from the factory default "Enable (^) / (v) keys on keypad (F01 = 0)" to "Enable current input to terminal [C1] (4 to 20 mA DC) (F01 = 2)."

- (1) Turn the inverter on. It automatically enters Running mode. In that mode, press the (PRG RESET) key to switch to Programming mode. The function selection menu appears. (In this example, 0.Fnc is displayed.)
- (2) If anything other than 0.Fnc is displayed, use the (^) and (v) keys to display 0.Fnc.
- (3) Press the (FUNC DATA) key to proceed to a list of function codes.
- (4) Use the (^) and (v) keys to display the desired function code (F 01 in this example), then press the (FUNC DATA) key.
The data of this function code appears. (In this example, data 0 of F 01 appears.)
- (5) Change the function code data using the (^) and (v) keys. (In this example, press the (^) key two times to change data 0 to 2.)
- (6) Press the (FUNC DATA) key to establish the function code data.
The SAVE appears and the data will be saved in the memory inside the inverter. The display will return to the function code list, then move to the next function code. (In this example, F 02.)
Pressing the (PRG RESET) key instead of the (FUNC DATA) key cancels the change made to the data. The data reverts to the previous value, the display returns to the function code list, and the original function code reappears.
- (7) Press the (PRG RESET) key to return to the menu from the function code list.

Tip Cursor movement

You can move the cursor when changing function code data by holding down the (PRG RESET) key for 1 second or longer in the same way as with the frequency settings. This action is called "Cursor movement."

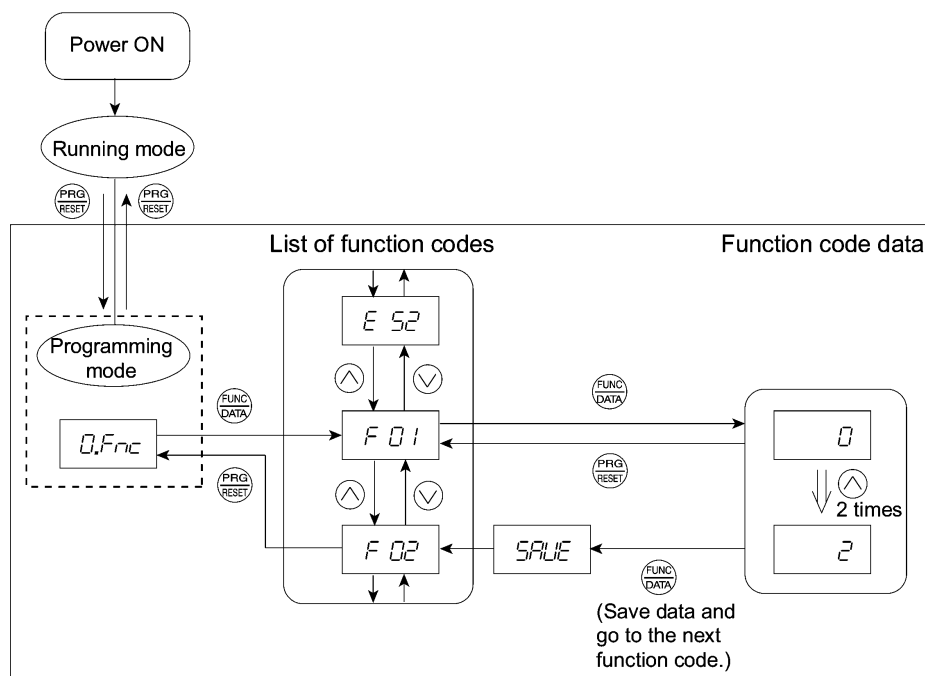

Figure 3.5 Example of Function Code Data Changing Procedure

3.3.2 Setting up function codes -- Menu #1 "Data Setting" --

Menu #1 "Data Setting" in Programming mode allows you to set up function codes for making the inverter functions match your needs.

To set function codes in this menu, it is necessary to set function code E52 to "0" (Function code data editing mode) or "2" (Full-menu mode).

Figure 3.6 shows the menu transition in Menu #1 "Data Setting."

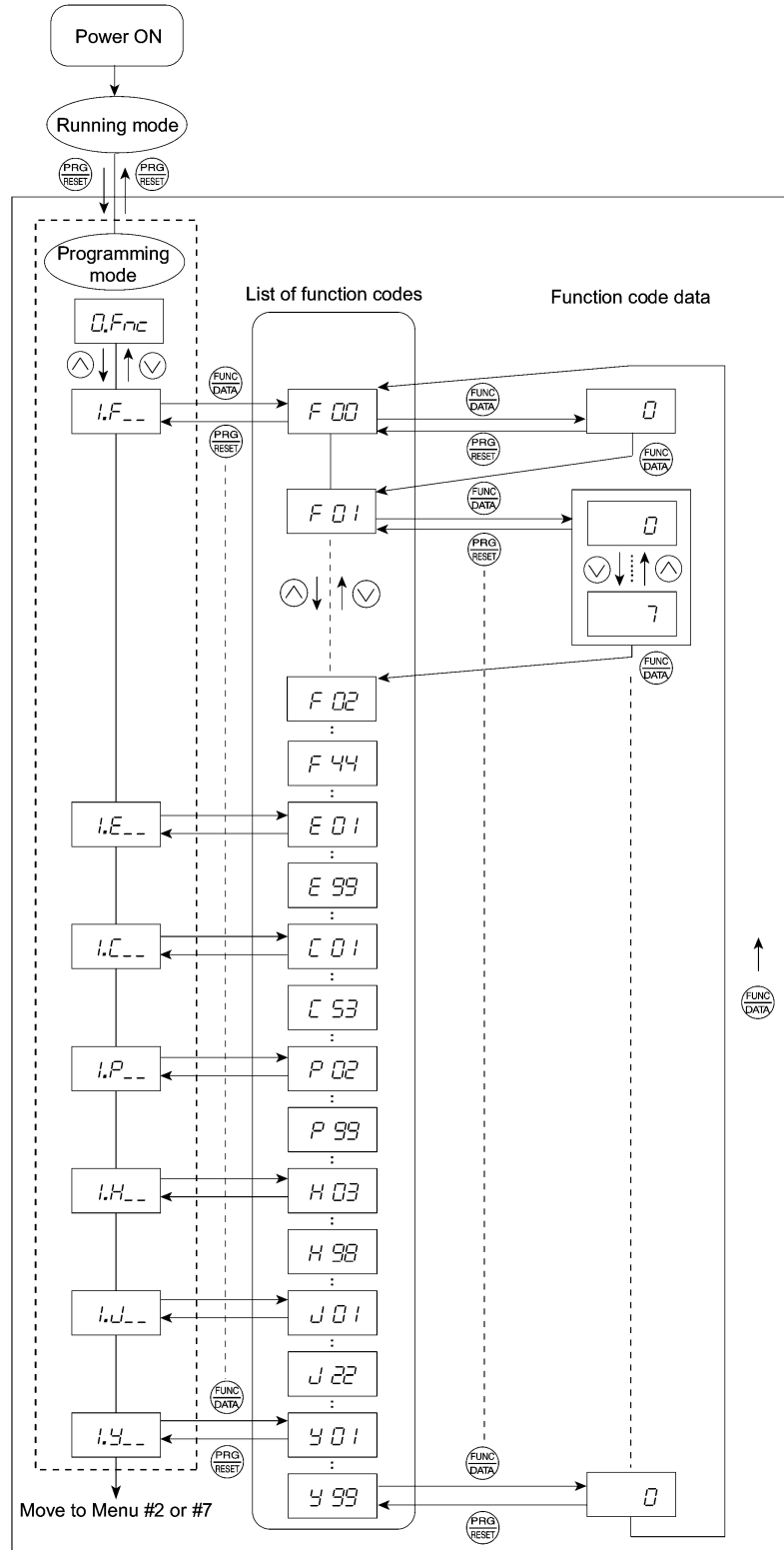

Figure 3.6 Menu Transition in Menu #1 "Data Setting"

Basic key operation

For details of the basic key operation, refer to Menu #0 "Quick Setup" in Section 3.3.1.

3.3.3 Checking changed function codes -- Menu #2 "Data Checking" --

Menu #2 "Data Checking" in Programming mode allows you to check function codes that have been changed. Only the function codes whose data has been changed from the factory defaults are displayed on the LED monitor. You can refer to the function code data and change it again if necessary. Figure 3.7 shows the menu transition in Menu #2 "Data Checking."

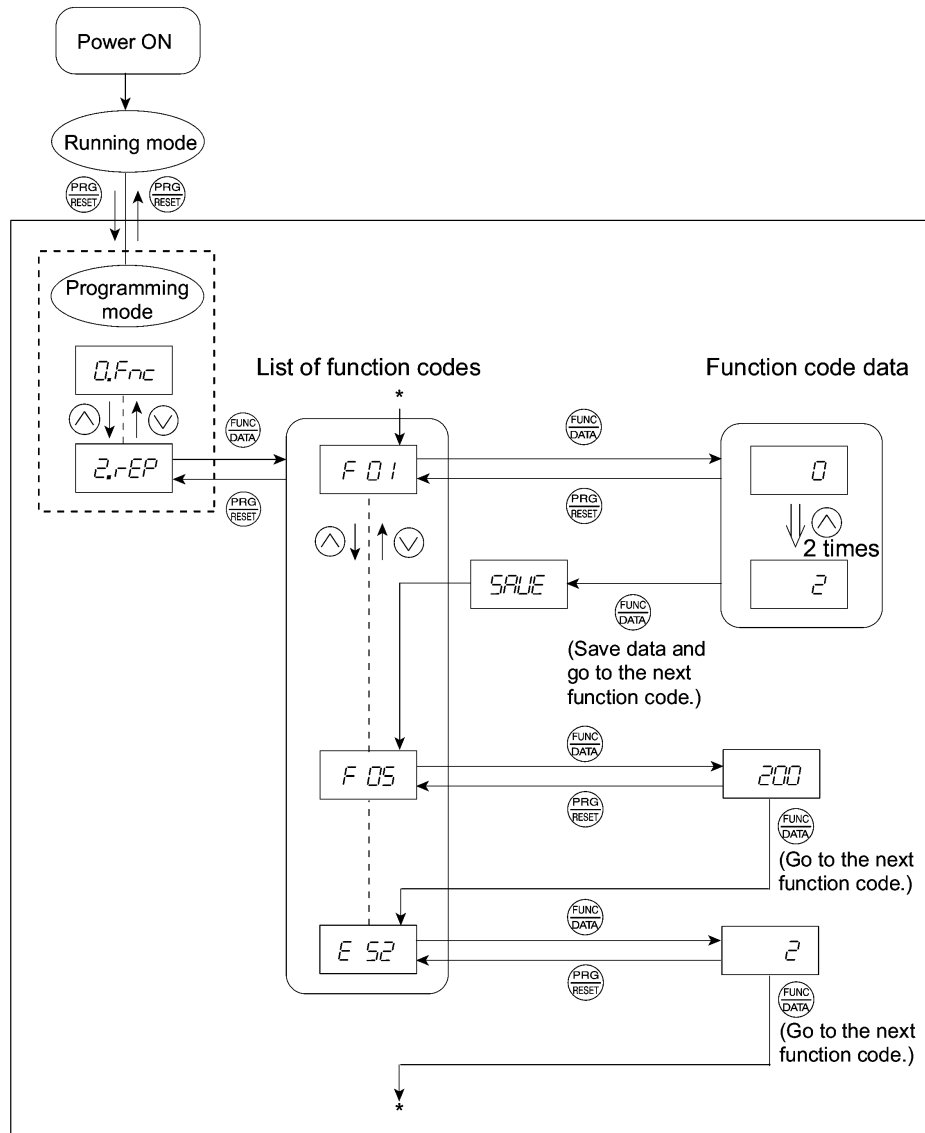

Figure 3.7 Menu Transition in Menu #2 "Data Checking" (Changing F01, F05 and E52 data only)

Basic key operation

For details of the basic key operation, refer to Menu #0 "Quick Setup" in Section 3.3.1.

Tip To check function codes in Menu #2 "Data Checking," it is necessary to set function code E52 to "1" (Function code data check mode) or "2" (Full-menu mode).

For details, refer to "■ Selecting menus to display" on page 3-13.

3.3.4 Monitoring the running status -- Menu #3 "Drive Monitoring" --

Menu #3 "Drive Monitoring" is used to monitor the running status during maintenance and trial running. The display items for "Drive Monitoring" are listed in Table 3.10. Figure 3.8 shows the menu transition in Menu #3 "Drive Monitoring."

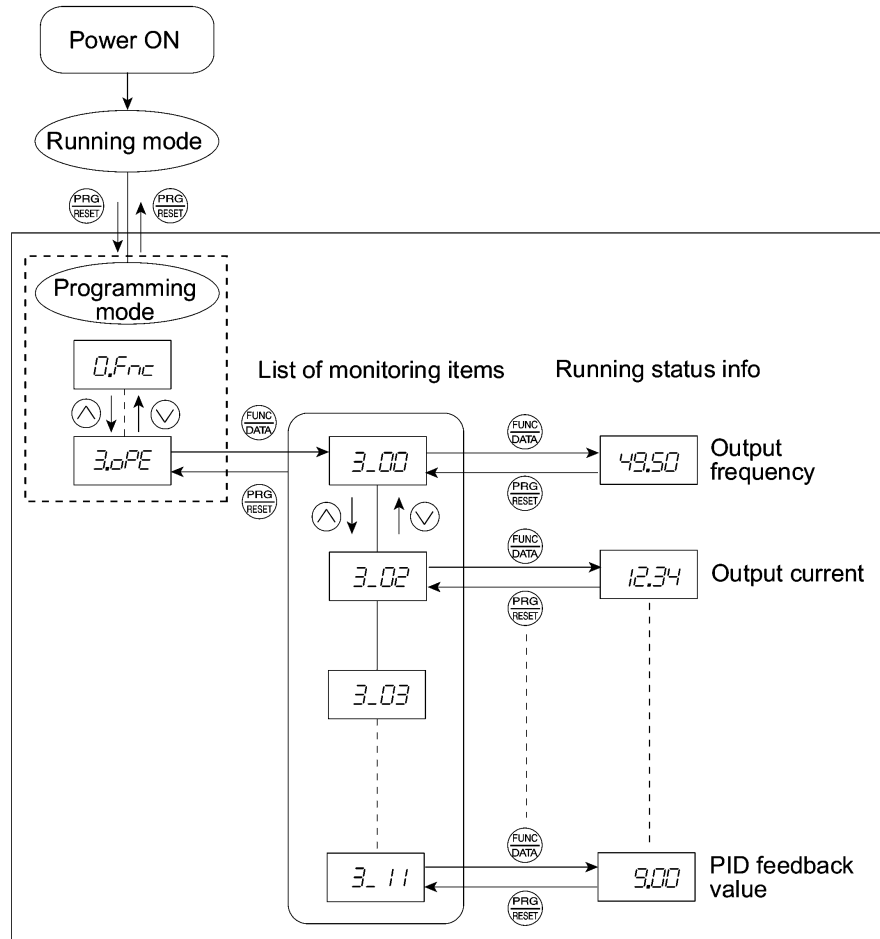

Figure 3.8 Menu Transition in Menu #3 "Drive Monitoring"

Basic key operation

To monitor the running status on the drive monitor, set function code E52 to "2" (Full-menu mode) beforehand.

- (1) Turn the inverter on. It automatically enters Running mode. In that mode, press the key to switch to Programming mode. The function selection menu appears.
- (2) Use the and keys to display "Drive Monitoring" (*3.0PE*).
- (3) Press the key to proceed to a list of monitoring items (e.g. *3.00*).
- (4) Use the and keys to display the desired monitoring item, then press the key. The running status information for the selected item appears.
- (5) Press the key to return to a list of monitoring items. Press the key again to return to the menu.

Table 3.10 Drive Monitor Display Items

LED monitor shows:	Item	Unit	Description
3.00	Output frequency	Hz	Output frequency
3.02	Output current	A	Output current
3.03	Output voltage	V	Output voltage
3.04	Calculated torque	%	Calculated output torque of the loaded motor in %
3.05	Reference frequency	Hz	Frequency specified by a frequency command
3.06	Rotational direction	N/A	Rotational direction being outputted F: forward; r: reverse, ----: stop
3.07	Running status	N/A	Running status in hexadecimal format Refer to " ■ Displaying running status " on the next page.
3.08	Motor speed	r/min	Display value = (Output frequency Hz) × $\frac{120}{\text{(Function code P01)}}$
3.09	Load shaft speed	r/min	Display value = (Output frequency Hz) × (Function code E50) The 7-segment letters E 3 appear for 10000 (r/min) or more. If E 3 appear, decrease function code E52 data so that the LED monitor displays 9999 or below, referring to the above equation.
3.10	PID process command	N/A	Virtual physical value (e.g., temperature or pressure) of the object to be controlled, which is converted from the PID process command using function code E40 and E41 data (PID display coefficients A and B) Display value = (PID process command) × (Coefficient A - B) + B If PID control is disabled, "----" appears.
3.11	PID feedback value	N/A	Virtual physical value (e.g., temperature or pressure) of the object to be controlled, which is converted from the PID process command using function code E40 and E41 data (PID display coefficients A and B) Display value = (PID feedback value) × (Coefficient A - B) + B If PID control is disabled, "----" appears.

■ Displaying running status

To display the running status in hexadecimal format, each state has been assigned to bits 0 to 15 as listed in Table 3.11. Table 3.12 shows the relationship between each of the status assignments and the LED monitor display. Table 3.13 gives the conversion table from 4-bit binary to hexadecimal.

Table 3.11 Running Status Bit Assignment

Bit	Notation	Content	Bit	Notation	Content
15	BUSY	1 when function code data is being written.	7	VL	1 under voltage limiting control.
14	WR	Always 0.	6	TL	Always 0.
13		Always 0.	5	NUV	1 when the DC link bus voltage is higher than the undervoltage level.
12	RL	1 when communication is enabled (when ready for run and frequency commands via communications link).	4	BRK	1 during braking.
11	ALM	1 when an alarm has occurred.	3	INT	1 when the inverter output is shut down.
10	DEC	1 during deceleration.	2	EXT	1 during DC braking.
9	ACC	1 during acceleration.	1	REV	1 during running in the reverse direction.
8	IL	1 under current limiting control.	0	FWD	1 during running in the forward direction.

Table 3.12 Running Status Display

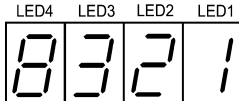
LED No.	LED4				LED3				LED2				LED1			
	15	14	13	12	11	10	9	8	7	6	5	4	3	2	1	0
Notation	BUSY	WR		RL	ALM	DEC	ACC	IL	VL	TL	NUV	BRK	INT	EXT	REV	FWD
Example	Binary	1	0	0	0	0	0	1	1	0	0	1	0	0	0	1
	Hexadecimal on the LED monitor	<div style="display: flex; justify-content: space-around; align-items: center;"> LED4 LED3 LED2 LED1 </div> 														

■ Hexadecimal expression

A 4-bit binary number can be expressed in hexadecimal format (1 hexadecimal digit). Table 3.13 shows the correspondence between the two notations. The hexadecimals are shown as they appear on the LED monitor.

Table 3.13 Binary and Hexadecimal Conversion

Binary				Hexadecimal	Binary				Hexadecimal
0	0	0	0	0	1	0	0	0	0
0	0	0	1	1	1	0	0	1	1
0	0	1	0	2	1	0	1	0	2
0	0	1	1	3	1	0	1	1	3
0	1	0	0	4	1	1	0	0	4
0	1	0	1	5	1	1	0	1	5
0	1	1	0	6	1	1	1	0	6
0	1	1	1	7	1	1	1	1	7

3.3.5 Checking I/O signal status -- Menu #4 "I/O Checking" --

Using Menu #4 "I/O Checking" displays the I/O status of external signals including digital and analog I/O signals without using a measuring instrument. Table 3.14 lists check items available. The menu transition in Menu #4 "I/O Checking" is shown in Figure 3.9.

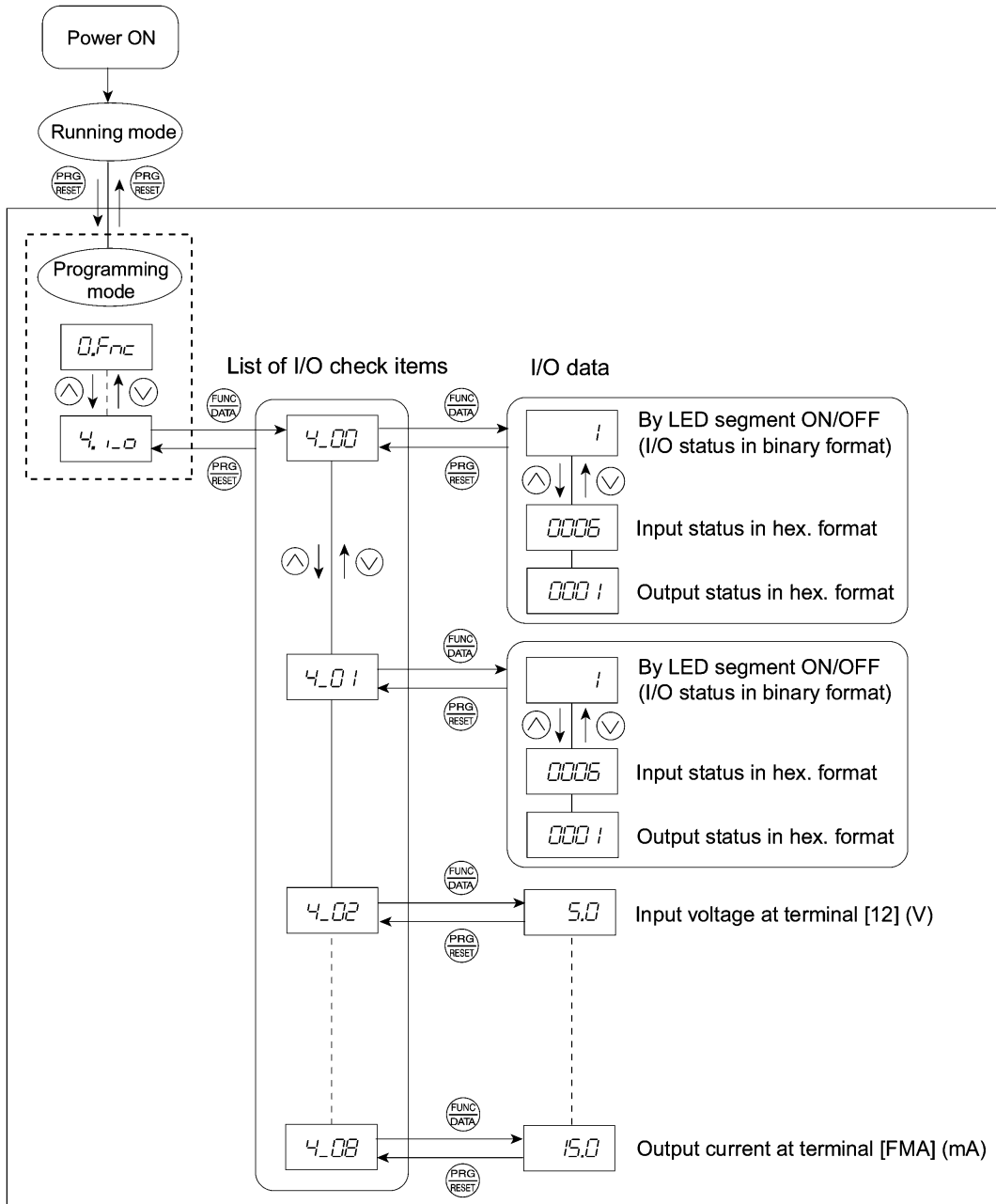

Figure 3.9 Menu Transition in Menu #4 "I/O Checking"

Basic key operation

To check the status of the I/O signals, set function code E52 to "2" (Full-menu mode) beforehand.











- (1) Turn the inverter on. It automatically enters Running mode. In that mode, press the  key to switch to Programming mode. The function selection menu appears.
- (2) Use the  and  keys to display "I/O Checking" (4_1_0).
- (3) Press the  key to proceed to a list of I/O check items (e.g. 4_00).
- (4) Use the  and  keys to display the desired I/O check item, then press the  key. The corresponding I/O check data appears. For the item 4_00 or 4_01, using the  and  keys switches the display method between the segment display (for external signal information in Table 3.15) and hexadecimal display (for I/O signal status in Table 3.16).
- (5) Press the  key to return to a list of I/O check items. Press the  key again to return to the menu.

Table 3.14 I/O Check Items

LED monitor shows:	Item	Description
4_00	I/O signals on the control circuit terminals	Shows the ON/OFF state of the digital I/O terminals. Refer to "■ Displaying control I/O signal terminals" on the next page for details.
4_01	I/O signals on the control circuit terminals under communications control	Shows the ON/OFF state for the digital I/O terminals that received a command via RS-485 and optional communications. Refer to "■ Displaying control I/O signal terminals" and "■ Displaying control I/O signal terminals under communications control" on the following pages for details.
4_02	Input voltage on terminal [12]	Shows the input voltage on terminal [12] in volts (V).
4_03	Input current on terminal [C1]	Shows the input current on terminal [C1] in milliamperes (mA).
4_04	Output voltage to analog meters [FMA]	Shows the output voltage on terminal [FMA] in volts (V).
4_05 *	Output voltage to digital meters [FMP]	Shows the output voltage on terminal [FMP] in volts (V).
4_06 *	Pulse rate of [FMP]	Shows the output pulse rate on terminal [FMP] in pulses per second (p/s).
4_07	Input voltage on terminal [V2]	Shows the input voltage on terminal [V2] in volts (V).
4_08	Output current to analog meters [FMA]	Shows the output current on terminal [FMA] in mA.
4_09 *	Output current to analog meters [FMI]	Shows the output current on terminal [FMI] in mA.

* The inverter has either [FMP] or [FMI] depending on the type of the control printed circuit board (control PCB).

The control PCB with a screw terminal block has [FMP] and it does not display 4_09; the one with a Europe type terminal block has [FMI] and it does not display 4_05 or 4_06.

■ Displaying control I/O signal terminals

The status of control I/O signal terminal may be displayed with ON/OFF of the LED segment or in hexadecimal display.

- Display I/O signal status with ON/OFF of each LED segment

As shown in Table 3.15 and the figure below, each of segments "a" to "g" on LED1 lights when the corresponding digital input terminal circuit ([FWD], [REV], [X1], [X2], [X3], [X4] or [X5]) is closed; it goes off when it is open (*1). Segment "a to c" and "e" on LED3 lights when the circuit between output terminal [Y1], [Y2], or [Y3] and terminal [CMY], or [Y5A] and [Y5C] is closed, and does not light when the circuit is open. Segment "a" and "e to g" on LED4 is for terminals [30A/B/C], and terminals [Y1A], [Y2A] and [Y3A] on the relay output option card. Segment "a" or "e to g" on LED4 lights when the circuit between terminals [30C] and [30A] or the relay terminal circuit of [Y1A], [Y2A] or [Y3A] is short-circuited (ON) respectively and does not light when it is open.

 **Tip** If all terminal input signals are OFF (open), segment "g" on all of LED1 to LED4 will blink ("-----").

Table 3.15 Segment Display for External Signal Information



Segment	LED4	LED3	LED2	LED1
a	30A/B/C	Y1-CMY	—	FWD (*1)
b	—	Y2-CMY	—	REV (*1)
c	—	Y3-CMY	—	X1 (*1)
d	—	—	—	X2 (*1)
e	Y1A	Y5A-Y5C	—	X3 (*1)
f	Y2A	—	(XF) (*2)	X4 (*1)
g	Y3A	—	(XR) (*2)	X5 (*1)
dp	—	—	(RST) (*2)	—

—: No corresponding control circuit terminal exists

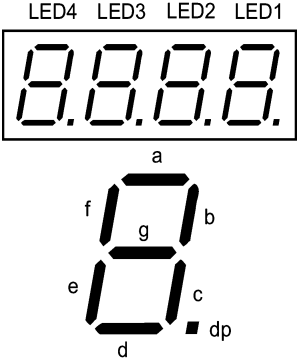
- (*1) For the open/close states of [FWD], [REV], [X1] through [X5] circuits, refer to the setting of the SINK/SOURCE slide switch in the FRENIC-Eco Instruction Manual (INR-SI47-1059-E), Chapter 2, Table 2.11 "Symbols, Names and Functions of the Control Circuit Terminals."
- (*2) (XF), (XR), and (RST) are assigned for communication. Refer to "■ Displaying control I/O signal terminals under communications control" on the next page.

• Displaying I/O signal status in hexadecimal format

Each I/O terminal is assigned to bit 15 through bit 0 as shown in Table 3.16. An unassigned bit is interpreted as "0." Allocated bit data is displayed on the LED monitor in 4 hexadecimal digits (LED4 to LED1 each).

With the FRENIC-Eco, digital input terminals [FWD] and [REV] are assigned to bit 0 and bit 1, respectively. Terminals [X1] through [X5] are assigned to bits 2 through 6. The bit is set to "1" when the corresponding input terminal is short-circuited (ON)*, and is set to "0" when it is open (OFF). For example, when [FWD] and [X1] are on (short-circuited) and all the others are off (open), 0005 is displayed on LED4 to LED1.

(*) For the open/close states of [FWD], [REV], [X1] through [X5] circuits, refer to the setting of the SINK/SOURCE slide switch in the FRENIC-Eco Instruction Manual (INR-SI47-1059-E), Chapter 2, Table 2.11 "Symbols, Names and Functions of the Control Circuit Terminals."

Digital output terminal [Y1] to [Y3] are assigned to bits 0 to 2. Each bit is set to "1" when the terminal is short-circuited with [CMY], and "0" when it is open. The status of the relay contact output [Y5A/C] is assigned to bit 4 and it is set to "1" when the circuit between [Y5A] and [Y5C] is closed.

The status of the relay contact output terminal [30A/B/C] is assigned to bit 8. It is set to "1" when the circuit between output terminals [30A] and [30C] is closed, and "0" when the circuit between [30B] and [30C] is closed.

The status of the relay contact output terminals [Y1A] to [Y3A] is assigned to bits 12 to 14. Each bit is set to "1" when the terminal circuits of [Y1A] to [Y1C] are closed, and "0" when they are open.

For example, if [Y1] is on, the circuit between [Y5A] and [Y5C] is open, the circuit between [30A] and [30C] is closed, and all [Y1A] to [Y3A] are open, then "0005" is displayed on the LED4 to LED1.

Table 3.16 presents an example of bit assignment and corresponding hexadecimal display on the 7-segment LED.

Table 3.16 Segment Display for I/O Signal Status in Hexadecimal Format

LED No.	LED4				LED3				LED2				LED1			
Bit	15	14	13	12	11	10	9	8	7	6	5	4	3	2	1	0
Input terminal	(RST)*	(XR)*	(XF)*	-	-	-	-	-	-	X5	X4	X3	X2	X1	REV	FWD
Output terminal	-	Y3A	Y2A	Y1A	-	-	-	30 A/B/C	-	-	-	Y5A/C	-	Y3	Y2	Y1
Example	Binary	0	0	0	0	0	0	0	0	0	0	0	0	1	0	1
	Hexadecimal on the LED monitor															

- No corresponding control terminal exists.

* (XF), (XR), and (RST) are assigned for communication. Refer to "**■ Displaying control I/O signal terminals under communications control**" below.

■ Displaying control I/O signal terminals under communications control

Under communications control, input commands (function code S06) sent via RS-485 or other optional communications can be displayed in two ways: "with ON/OFF of each LED segment" and "in hexadecimal format." The content to be displayed is basically the same as that for the control I/O signal terminal status display; however, (XF), (XR), and (RST) are added as inputs. Note that under communications control, the I/O display is in normal logic (using the original signals not inverted).

Refer to the RS-485 Communication User's Manual (MEH448) for details on input commands sent through RS-485 communications and the instruction manual of communication-related options as well.

3.3.6 Reading maintenance information

-- Menu #5 "Maintenance Information" --

Menu #5 "Maintenance Information" contains information necessary for performing maintenance on the inverter. Table 3.17 lists the maintenance information display items and Figure 3.10 shows the menu transition in Menu #5 "Maintenance information."

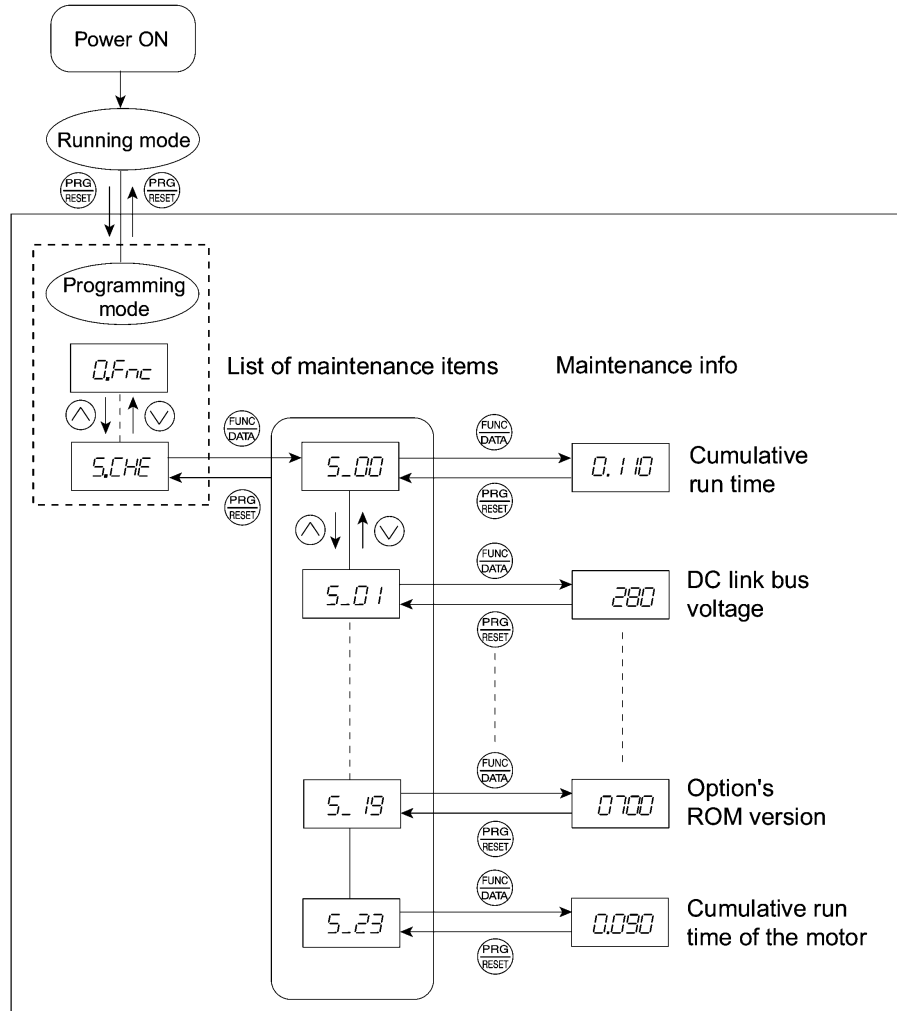

Figure 3.10 Menu Transition in Menu #5 "Maintenance Information"

Basic key operation

To view the maintenance information, set function code E52 to "2" (Full-menu mode) beforehand.

- (1) Turn the inverter on. It automatically enters Running mode. In that mode, press the key to switch to Programming mode. The function selection menu appears.
- (2) Use the and keys to display "Maintenance Information" (*S.CHE*).
- (3) Press the key to proceed to a list of maintenance item codes (e.g. *S.00*).
- (4) Use the and keys to display the desired maintenance item, then press the key. The data of the corresponding maintenance item appears.
- (5) Press the key to return to a list of maintenance items. Press the key again to return to the menu.

Table 3.17 Display Items for Maintenance Information

LED Monitor shows:	Item	Description
5.00	Cumulative run time	Shows the content of the cumulative power-ON time counter of the inverter. Unit: thousands of hours. (Display range: 0.001 to 9.999, 10.00 to 65.53) When the total ON-time is less than 10000 hours (display: 0.001 to 9.999), data is shown in units of one hour (0.001). When the total time is 10000 hours or more (display: 10.00 to 65.53), it is shown in units of 10 hours (0.01). When the total time exceeds 65535 hours, the counter will be reset to 0 and the count will start again.
5.01	DC link bus voltage	Shows the DC link bus voltage of the inverter main circuit. Unit: V (volts)
5.02	Max. temperature inside the inverter	Shows a maximum temperature inside the inverter for every hour. Unit: °C (Temperatures below 20°C are displayed as 20°C.)
5.03	Max. temperature of heat sink	Shows the maximum temperature of the heat sink for every hour. Unit: °C (Temperatures below 20°C are displayed as 20°C.)
5.04	Max. effective output current	Shows the maximum current in RMS for every hour. Unit: A (amperes)
5.05	Capacitance of the DC link bus capacitor	Shows the current capacitance of the DC link bus capacitor (reservoir capacitor) in %, based on the capacitance when shipping as 100%. Refer to the FRENIC-Eco Instruction Manual (INR-SI47-1059-E), Chapter 7 "MAINTENANCE AND INSPECTION" for details. Unit: %
5.06	Cumulative run time of electrolytic capacitors on the printed circuit boards	Shows the content of the cumulative run time counter of the electrolytic capacitor mounted on the printed circuit board. The display method is the same as for "Cumulative run time (5.00) above." However, when the total time exceeds 65535 hours, the count stops and the display remains at 65.53.
5.07	Cumulative run time of the cooling fan	Shows the content of the cumulative run time counter of the cooling fan. This counter does not work when the cooling fan ON/OFF control (function code H06) is enabled but the fan does not run. The display method is the same as for "Cumulative run time (5.00) above." However, when the total time exceeds 65535 hours, the count stops and the display remains at 65.53.
5.08	Number of startups	Shows the content of the cumulative counter of times the inverter is started up (i.e., the number of run commands issued). 1.000 indicates 1000 times. When any number from 0.001 to 9.999 is displayed, the counter increases by 0.001 per startup, and when any number from 10.00 to 65.53 is counted, the counter increases by 0.01 every 10 startups. When the counted number exceeds 65535, the counter will be reset to 0 and the count will start again.
5.09	Input watt-hour	Shows the input watt-hour of the inverter. Unit: 100 kWh (Display range: 0.001 to 9999) Depending on the value of integrated input watt-hour, the decimal point on the LED monitor shifts to show it within the LED monitors' resolution (e.g. the resolution varies between 0.001, 0.01, 0.1 or 1). To reset the integrated input watt-hour and its data, set function code E51 to "0.000." When the input watt-hour exceeds 1000000 kWh, it returns to "0."

Table 3.17 Continued

LED Monitor shows:	Item	Description
<i>S_10</i>	Input watt-hour data	Shows the value expressed by "input watt-hour (kWh) × E51 (whose data range is 0.000 to 9999)." Unit: None. (Display range: 0.001 to 9999. The data cannot exceed 9999. (It will be fixed at 9999 once the calculated value exceeds 9999.)) Depending on the value of integrated input watt-hour data, the decimal point on the LED monitor shifts to show it within the LED monitors' resolution. To reset the integrated input watt-hour data, set function code E51 to "0.000."
<i>S_11</i>	No. of RS-485 errors (standard)	Shows the total number of errors that have occurred in <i>standard</i> RS-485 communication (via the RJ-45 connector as standard) since the power is turned on. Once the number of errors exceeds 9999, the count returns to 0.
<i>S_12</i>	Content of RS-485 communications error (standard)	Shows the latest error that has occurred in <i>standard</i> RS-485 communication in decimal format. For error contents, refer to the RS-485 Communication User's Manual (MEH448).
<i>S_13</i>	No. of option errors	Shows the total number of optional communications card errors since the power is turned on. Once the number of errors exceeds 9999, the count returns to 0.
<i>S_14</i>	Inverter's ROM version	Shows the inverter's ROM version as a 4-digit code.
<i>S_15</i>	Keypad's ROM version	Shows the keypad's ROM version as a 4-digit code.
<i>S_17</i>	No. of RS-485 errors (option)	Shows the total number of errors that have occurred in <i>optional</i> RS-485 communication since the power is turned on. Once the number of errors exceeds 9999, the count returns to 0.
<i>S_18</i>	Content of RS-485 communications error (option)	Shows the latest error that has occurred in <i>optional</i> RS-485 communication in decimal format. For error contents, refer to the RS-485 Communication User's Manual (MEH448).
<i>S_19</i>	Option's ROM version	Shows the option's ROM version as a 4-digit code.
<i>S_23</i>	Cumulative motor run time	Shows the content of the cumulative power-ON time counter of the motor. The display method is the same as for "Cumulative run time (<i>S_00</i>)" above.

3.3.7 Reading alarm information -- Menu #6 "Alarm Information" --

Menu #6 "Alarm Information" shows the causes of the past 4 alarms in alarm code. Further, it is also possible to display alarm information that indicates the status of the inverter when the alarm occurred. Figure 3.11 shows the menu transition in Menu #6 "Alarm Information" and Table 3.18 lists the details of the alarm information.

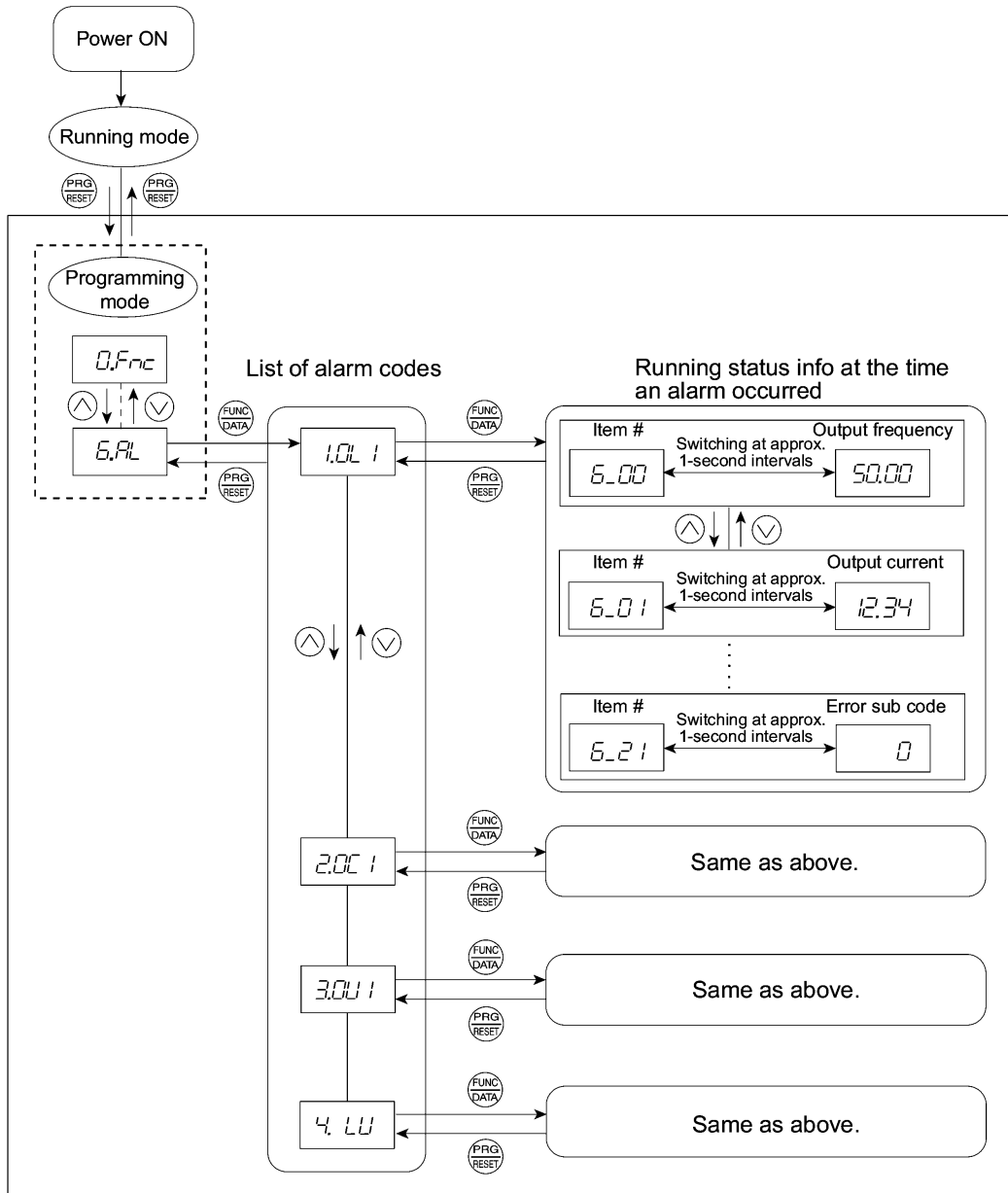

Figure 3.11 "Alarm Information" Menu Transition

Basic key operation

To view the alarm information, set function code E52 to "2" (Full-menu mode) beforehand.











- (1) Turn the inverter on. It automatically enters Running mode. In that mode, press the  key to switch to Programming mode. The function selection menu appears.
- (2) Use the  and  keys to display "Alarm Information" (E.AL).
- (3) Press the  key to proceed to a list of alarm codes (e.g. 1.01).
In the list of alarm codes, the alarm information for the last 4 alarms is saved as an alarm history.
- (4) Each time the  or  key is pressed, the last 4 alarms are displayed in order from the most recent one as 1, 2, 3 and 4.
- (5) While the alarm code is displayed, press the  key to have the corresponding alarm item number (e.g. E_01) and data (e.g. Output frequency) displayed alternately in intervals of approximately 1 second. You can also have the item number (e.g. E_01) and data (e.g. Output current) for any other item displayed using the  and  keys.
- (6) Press the  key to return to a list of alarm codes. Press the  key again to return to the menu.

Table 3.18 Alarm Information Displayed

LED monitor shows: (item No.)	Item displayed	Description
E_00	Output frequency	Output frequency
E_01	Output current	Output current
E_02	Output voltage	Output voltage
E_03	Calculated torque	Calculated motor output torque
E_04	Reference frequency	Frequency specified by frequency command
E_05	Rotational direction	This shows the rotational direction being output. F: forward; r: reverse; ----: stop
E_06	Running status	This shows the running status in hexadecimal. Refer to " ■ Displaying running status " in Section 3.3.4.
E_07	Cumulative run time	Shows the content of the cumulative power-ON time counter of the inverter. Unit: thousands of hours. (Display range: 0.001 to 9.999, 10.00 to 65.53) When the total ON-time is less than 10000 hours (display: 0.001 to 9.999), data is shown in units of one hour (0.001). When the total time is 10000 hours or more (display: 10.00 to 65.53), it is shown in units of 10 hours (0.01). When the total time exceeds 65535 hours, the counter will be reset to 0 and the count will start again.
E_08	No. of startups	Shows the content of the cumulative counter of times the inverter is started up (i.e., the number of run commands issued). 1.000 indicates 1000 times. When any number from 0.001 to 9.999 is displayed, the counter increases by 0.001 per startup, and when any number from 10.00 to 65.53 is counted, the counter increases by 0.01 every 10 startups. When the counted number exceeds 65535, the counter will be reset to 0 and the count will start again.
E_09	DC link bus voltage	Shows the DC link bus voltage of the inverter main circuit. Unit: V (volts)
E_10	Temperature inside the inverter	Shows the temperature inside the inverter when an alarm occurs. Unit: °C

Table 3.18 Continued

LED monitor shows: (item No.)	Item displayed	Description
<i>E_11</i>	Max. temperature of heat sink	Shows the temperature of the heat sink. Unit: °C
<i>E_12</i>	Terminal I/O signal status (displayed with the ON/OFF of LED segments)	Shows the ON/OFF status of the digital I/O terminals. Refer to " ■ Displaying control I/O signal terminals " in Section 3.3.5 "Checking I/O signal status" for details.
<i>E_13</i>	Terminal input signal status (in hexadecimal format)	
<i>E_14</i>	Terminal output signal status (in hexadecimal format)	
<i>E_15</i>	No. of consecutive occurrences	This is the number of times the same alarm occurs consecutively.
<i>E_16</i>	Multiple alarm 1	Simultaneously occurring alarm codes (1) ("----" is displayed if no alarms have occurred.)
<i>E_17</i>	Multiple alarm 2	Simultaneously occurring alarm codes (2) ("----" is displayed if no alarms have occurred.)
<i>E_18</i>	Terminal I/O signal status under communications control (displayed with the ON/OFF of LED segments)	Shows the ON/OFF status of the digital I/O terminals under RS-485 communications control. Refer to " ■ Displaying control I/O signal terminals under communications control " in Section 3.3.5 "Checking I/O signal status" for details.
<i>E_19</i>	Terminal input signal status under communications control (in hexadecimal format)	
<i>E_20</i>	Terminal output signal status under communications control (in hexadecimal format)	
<i>E_21</i>	Error sub code	Secondary error code for the alarm.



When the same alarm occurs repeatedly in succession, the alarm information for the first and last occurrences will be preserved and the information for other occurrences inbetween will be discarded. Only the number of consecutive occurrences will be updated.

3.3.8 Data copying information -- Menu #7 "Data Copying" --

Menu #7 "Data Copying" is used to read function code data out of an inverter for which function codes are already set up and then to write such function code data altogether into another inverter, or to verify the function code data stored in the keypad with the one registered in the inverter.

■ If data copying does not work

Check whether *Err* or *CPER* is blinking.

- (1) If *Err* is blinking (a write error), any of the following problems has arisen:
 - No data exists in the keypad memory. (No data read operation has been performed since shipment, or a data read operation has been aborted.)
 - Data stored in the keypad memory contains any error.
 - The models of copy source and destination inverters are different.
 - A data write operation has been performed while the inverter is running.
 - The copy destination inverter is data-protected. (function code F00=1)
 - In the copy destination inverter, the "Enable write from keypad" command (WE-KP) is off.
 - A read data operation has been performed for the inverter whose data protection was enabled.
- (2) If *CPER* is blinking, any of the following problems has arisen:
 - The function codes stored in the keypad and ones registered in the inverter are not compatible with each other. (Either of the two may have been revised or upgraded in a non-standard or incompatible manner. Contact your Fuji Electric representative.)

Figure 3.12 shows the menu transition in Menu #7 "Data Copying." Table 3.19 provides a detailed description of the Data Copying functions. The keypad can hold function codes for just one inverter.

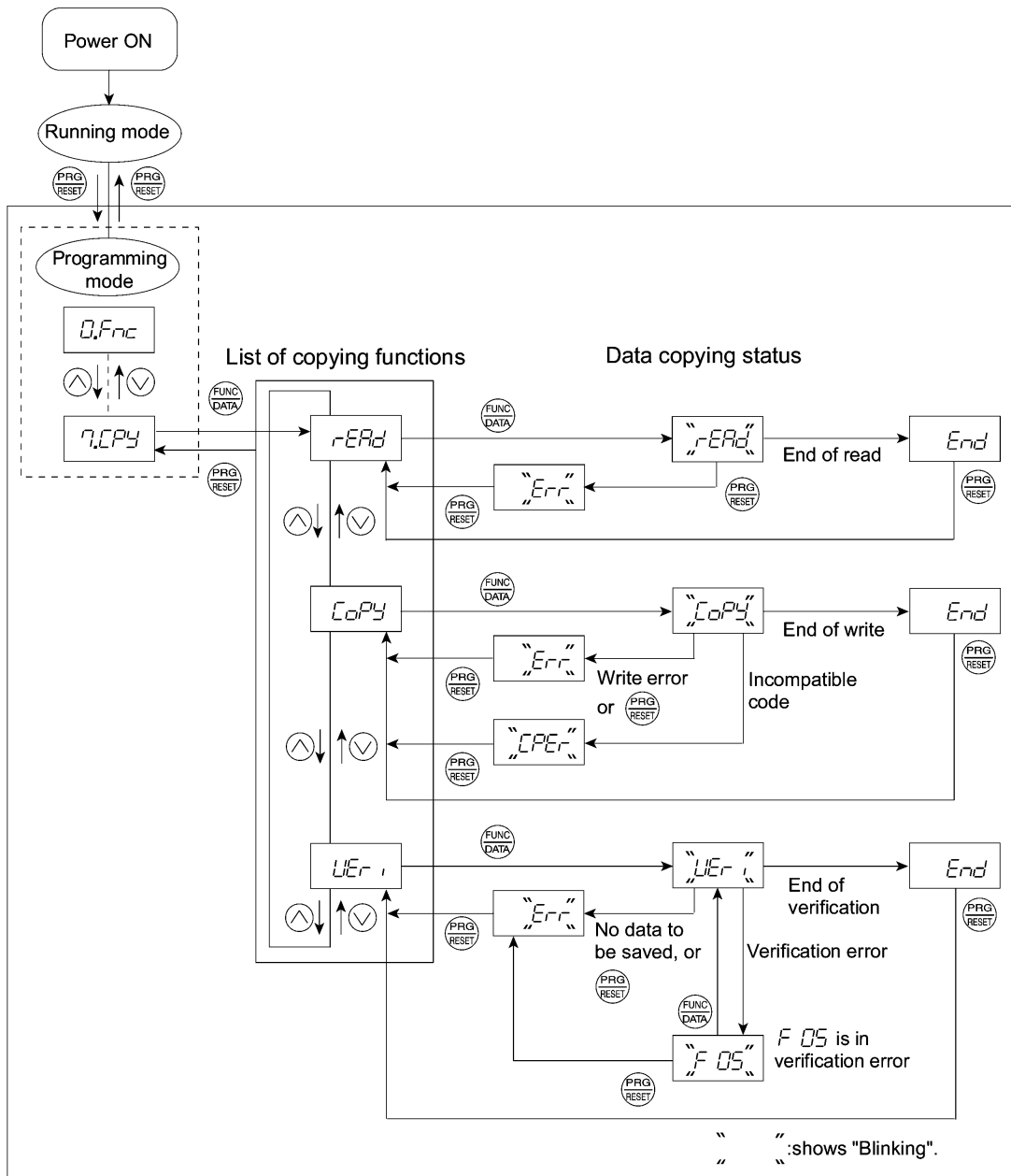











Figure 3.12 Menu Transition in Menu #7 "Data Copying"

Basic keying operation

- (1) Turn the inverter on. It automatically enters Running mode. In that mode, press the  key to switch to Programming mode. The function selection menu appears.
- (2) Use the  and  keys to display "Data Copying" (*COPY*).
- (3) Press the  key to proceed to a list of copying functions (e.g. *READ*).
- (4) Use the  and  keys to select the desired function, then press the  key to execute the selected function. (e.g. *READ* will blink.)
- (5) When the selected function has been executed, *END* appears. Press the  key to return to the data copying function list. Press the  key again to return to the menu.

■ Data protection

You can protect data saved in the keypad from unexpected modifications. Enabling the data protection that was disabled changes the display *READ* on the Data copying function list to *Prd*, and disables to read data from the inverter.

To enable or disable the data protection, follow the next steps.

- (1) Select the data copy *COPY* in the Program mode menu.
- (2) Holding the  key down for 5 seconds or more alternates data protection status between enabled or disabled.
 - Disabling the enabled Data protection

----- Hold  key down for 5 seconds. ----->

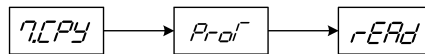

While running the Data copying (*COPY*) function, holding the  key down for 5 seconds displays *READ* after appearing *Prd* temporarily to complete disabling the Data protection.

- Enabling the disabled Data protection

----- Hold  key down for 5 seconds. ----->

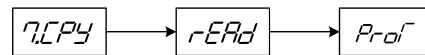







While running the Data copying (*COPY*) function, holding the  key down for 5 seconds displays *Prd* after appearing *READ* temporarily to complete disabling the Data protection.

Table 3.19 on the next page lists details of the Data copying function.

Table 3.19 List of Data Copying Functions



Display on LED Monitor	Function	Description
<i>r-ERd</i>	Read data	<p>Reads the function code data out of the inverter's memory and stores it into the keypad memory.</p> <p>Pressing the  key during a read operation (<i>r-ERd</i> blinking) immediately aborts the operation and displays <i>Err</i> (blinking). (*)</p> <p>If this happens, the entire contents of the memory of the keypad will be completely cleared.</p>
<i>CPY</i>	Write data	<p>Writes data stored in the keypad memory into the inverter's memory.</p> <p>Pressing the  key during a write operation (<i>CPY</i> blinking) immediately aborts the operation and displays <i>Err</i> (blinking). (*)</p> <p>The contents (function code data,) of the inverter's memory remain partly old and partly updated. If this happens, do not operate the inverter; instead, perform initialization or rewrite the entire data.</p> <p>If any incompatible code is about to be written, <i>PEr</i> appears blinking.</p> <p>If this function does not work, refer to "■ If data copying does not work" on page 3-32.</p>
<i>VER</i>	Verify data	<p>Verifies (collates) the data stored in the keypad memory with that in the inverter's memory.</p> <p>If any mismatch is detected, the verify operation will be aborted, with the function code in disagreement displayed blinking. Pressing the  key again causes the verification to continue from the next function code.</p> <p>Pressing the  key during a verify operation (<i>VER</i> blinking) immediately aborts the operation and displays <i>Err</i> (blinking). (*)</p> <p><i>Err</i> appears blinking(*) also when the keypad does not contain any valid data.</p>
<i>Prd</i>	Enable Data protection	<p>Enables the Data protection of data stored in the inverter's memory.</p> <p>In this state, you cannot read any data stored in the inverter's memory, but write data into the memory and verify data in the memory.</p> <p>Upon pressing the  key the inverter immediately displays <i>Err</i>.</p>

(*) To get out of the error state indicated by a blinking *Err* or *PEr*, press the  key.



3.4 Alarm Mode

If an abnormal condition arises, the protective function is invoked to issue an alarm, and the inverter automatically enters Alarm mode. At the same time, an alarm code appears on the LED monitor.

3.4.1 Releasing the alarm and switching to Running mode



Remove the cause of the alarm and press the  key to release the alarm and return to Running mode. The alarm can be removed using the  key only when the alarm code is displayed.

3.4.2 Displaying the alarm history



It is possible to display the most recent 3 alarm codes in addition to the one currently displayed. Previous alarm codes can be displayed by pressing the  /  key while the current alarm code is displayed.

3.4.3 Displaying the status of inverter at the time of alarm

When the alarm code is displayed, you may check various running status information (output frequency and output current, etc.) by pressing the  key. The item number and data for each running information will be displayed alternately.

Further, you can view various pieces of information on the running status of the inverter using the  /  key. The information displayed is the same as for Menu #6 "Alarm Information" in Programming mode. Refer to Table 3.18 in Section 3.3.7, "Reading alarm information."

Pressing the  key while the running status information is displayed returns the display to the alarm codes.

 **Note** When the running status information is displayed after removal of the alarm cause, pressing the  key twice returns to the alarm code display and releases the inverter from the alarm state. This means that the motor starts running if a run command has been received by this time.

3.4.4 Switching to Programming mode



You can also switch to Programming mode by pressing  +  keys simultaneously with the alarm displayed, and modify the function code data.

Figure 3.13 summarizes the possible transitions between different menu items.

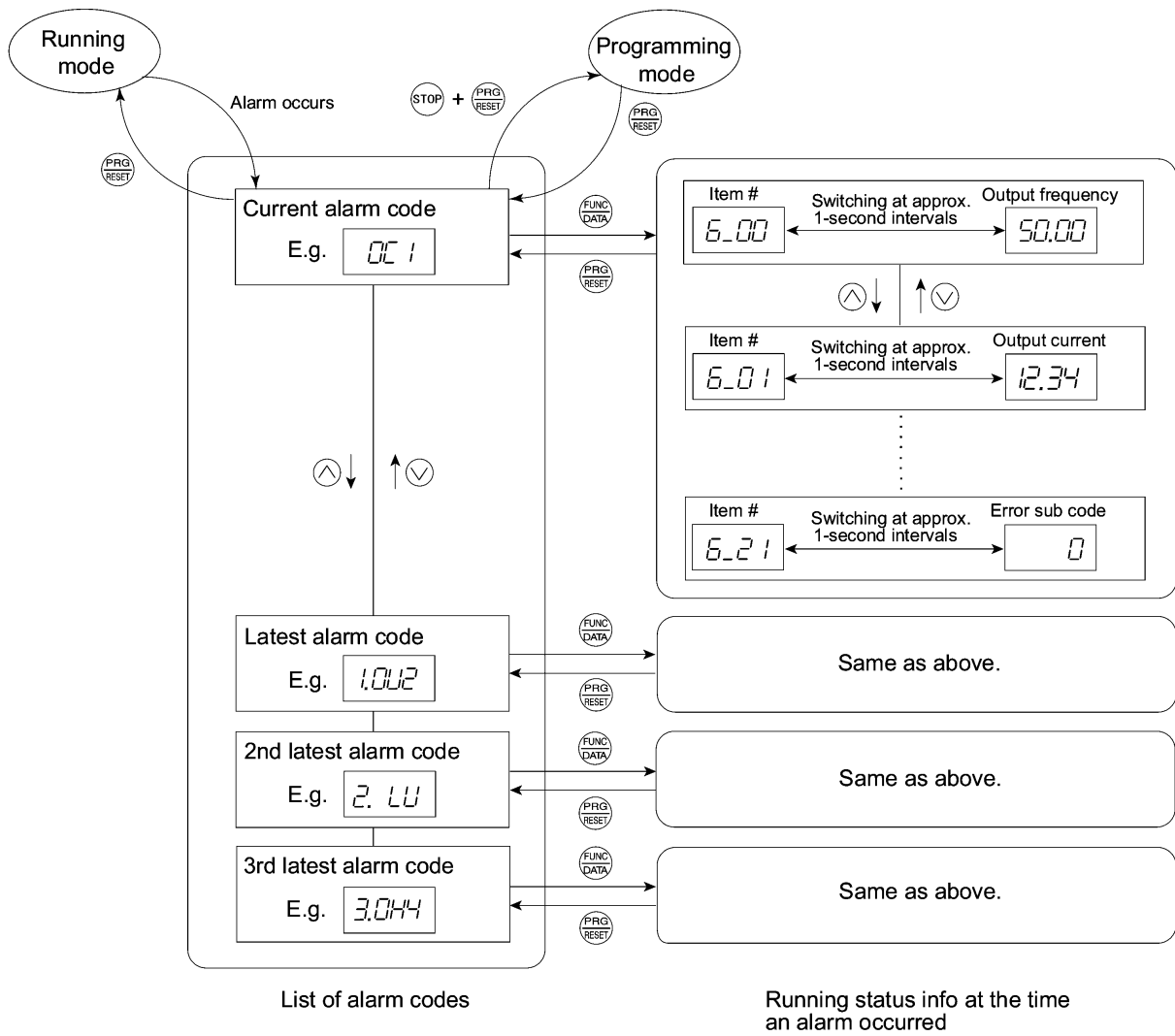

Figure 3.13 Menu Transition in Alarm Mode

Part 2 Driving the Motor



Chapter 4 BLOCK DIAGRAMS FOR CONTROL LOGIC

Chapter 5 RUNNING THROUGH RS-485 COMMUNICATION

Chapter 4

BLOCK DIAGRAMS FOR CONTROL LOGIC

This chapter describes the main block diagrams for the control logic of the FRENIC-Eco series of inverters.

Contents

4.1	Symbols Used in Block Diagrams and their Meanings	4-1
4.2	Drive Frequency Command Generator	4-2
4.3	Drive Command Generator	4-4
4.4	Digital Terminal Command Decoder	4-6
4.4.1	Terminals and related function codes	4-6
4.4.2	Functions assigned to digital control input terminals	4-7
4.4.3	Block diagrams for digital control input terminals	4-8
[1]	Digital control input block (General)	4-8
[2]	Digital control input block (Only for terminals)	4-9
[3]	Digital control input block (ORing the signals on terminals and the communications link).....	4-9
[4]	Digital control input block (Forced to turn off the signals on terminals during (LE) being turned on).....	4-10
[5]	Assigning terminal functions via the communications link (Access to function code S06 exclusively reserved for the communications link).....	4-11
4.5	Digital Output Selector	4-12
4.5.1	Digital output components (Internal block)	4-12
4.5.2	Universal DO (Access to the function code S07 exclusively reserved for the communications link).....	4-15
4.6	Analog Output (FMA and FMI) Selector.....	4-16
4.7	Drive Command Controller.....	4-17
4.8	PID Frequency Command Generator.....	4-19

FRENIC-Eco series of inverters for variable torque loads increasing in proportion to the square of speed such as fans and pumps are equipped with a number of function codes to match a variety of motor operations required in your system. Refer to Chapter 9 "FUNCTION CODES" for details of the function codes.

The function codes have functional relationship each other. Several special function codes also work with execution priority each other depending on their functions or data settings.







This chapter explains the main block diagrams for control logic in the inverter. You are requested to fully understand the inverter's control logic together with the function codes in order to set the function code data correctly.

The block diagrams contained in this chapter show only function codes having mutual relationship. For the function codes that work independently and for detailed explanation of each function code, refer to Chapter 9 "FUNCTION CODES."

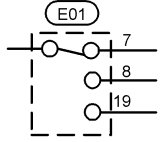
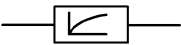
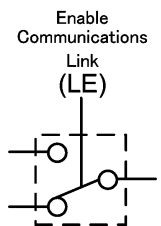
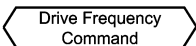
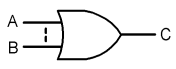
4.1 Symbols Used in Block Diagrams and their Meanings

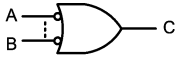
Table 4.1 lists symbols commonly used in block diagrams and their meanings with some examples.

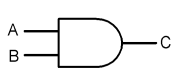
Table 4.1 Symbols and Meanings

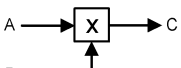
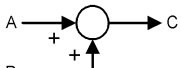
Symbol	Meaning	Symbol	Meaning
[FWD], [Y1] etc.	Digital inputs/outputs to/from the inverter's control terminal block.	(F01)	Function code.
(FWD), (REV) etc.	Terminal commands assigned to digital inputs/outputs.		Switch controlled by a function code. Numbers assigned to the terminals express the function code data.
	Low-pass filter: Features appropriate characteristics by changing the time constant through the function code data.		Switch controlled by a terminal command. In the example shown on the left, the enable communications link command (LE) assigned to one of the digital input terminals from [X1] to [X5] controls the switch.
	Internal control command for inverter logic.		OR logic: In normal logic, if any input is ON, then C = ON. Only if all inputs are OFF, then C = OFF.
	High limiter: Limits the upper value by a constant or data set to a function code.		NOR (Not-OR) logic: In normal logic, if any input is OFF, then C = ON. If all inputs are ON, C = OFF.
	Low limiter: Limits the lower value by a constant or data set to a function code.		AND logic: In normal logic, only if A = ON and B = ON, then C = ON. Otherwise, C = OFF.
	Zero limiter: Prevents data from dropping to a negative value.		NOT logic: In normal logic, if A = ON, then B = OFF, and vice versa.
	Gain multiplier for reference frequencies given by current and/or voltage input or for analog output signals. $C = A \times B$		
	Adder for 2 signals or values. $C = A + B$ If B is negative then $C = A - B$ (acting as a subtracter).		

4.2 Drive Frequency Command Generator

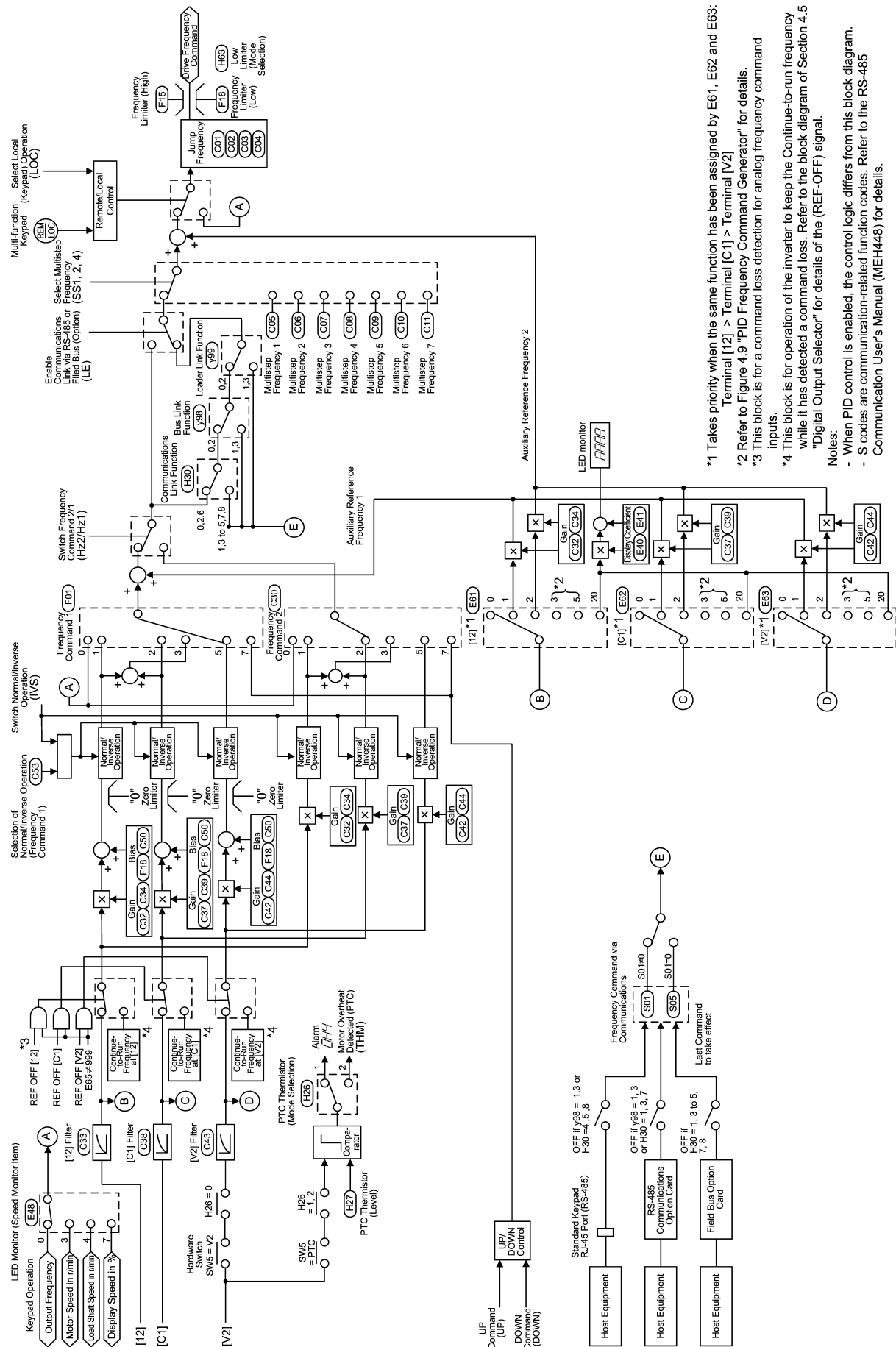

- *1 Takes priority when the same function has been assigned by E61, E62 and E63: Terminal [12] > Terminal [C1] > Terminal [V2]
 - *2 Refer to Figure 4.9 "PID Frequency Command Generator" for details.
 - *3 This block is for a command loss detection for analog frequency command inputs.
 - *4 This block is for operation of the inverter to keep the Continue-to-run frequency while it has detected a command loss. Refer to the block diagram of Section 4.5 "Digital Output Selector" for details of the (REF-OFF) signal.
- Notes:
- When PID control is enabled, the control logic differs from this block diagram.
 - S codes are communication-related function codes. Refer to the RS-485 Communication User's Manual (MEH448) for details.

Figure 4.1 Block Diagram of Drive Frequency Command Generator

Figure 4.1 shows the processes that generate the internal drive frequency command through the various frequency command and switching steps by means of function codes. If PID process control takes effect (J01=1 or 2), the drive frequency command generator will differ from that shown in this diagram. (Refer to Section 4.8 "PID Frequency Command Generator.")

Additional and supplemental information is given below.

- Frequency command sources using the \wedge / \vee key on the keypad may take different formats such as motor speed in r/min, load shaft speed in r/min or speed in % by means of the data setup of function code E48. Refer to the function code E48 in Chapter 9 "FUNCTION CODES" for details.
- If the voltage input terminal [V2] is specified to the PTC thermistor input (i.e. setting the slide switch SW5 on the control printed circuit board (control PCB) to the PTC side and setup of function code H26 data at 1 or 2), then the frequency command input signal on the terminal [V2] will always be interpreted as "0."
- Case that data setup for both the gain and bias will take effect concurrently is only available for the frequency command source 1 (F01). For the frequency command source 2 (C30) and auxiliary frequency command sources 1 and 2 (E61 to E63), only setup of the gain will take effect.
- Switching between normal and inverse operation is only effective for the reference frequency from the analog frequency command input signal (terminal [12], [C1] or [V2]). Note that the frequency command source set up by using the \wedge / \vee key is only valid for normal operation.
- Frequency commands by S01 and S05 for the communications link facility take different command formats as follows.
 - S01: the setting range is -32768 to $+32767$, where the maximum frequency is obtained at ± 20000
 - S05: the setting range is 0.00 to 655.35 Hz in increments of 0.01 Hz
 - Basically, priority level for the command in S01 is higher than that in S05. If a value other than "0" is set in S01, the data set in S01 will take effect. If S01 is set at "0", data in S05 will take effect.
 - Refer to the RS-485 Communication User's Manual (MEH448) for details.
- The frequency limiter (Low) (F16) helps user select the inverter operation for either the output frequency is held at data of the frequency limiter (lower), or the inverter decelerates to stop the motor with reference frequency data of "0", by specifying the lower limiter (select) (H63.)

4.3 Drive Command Generator

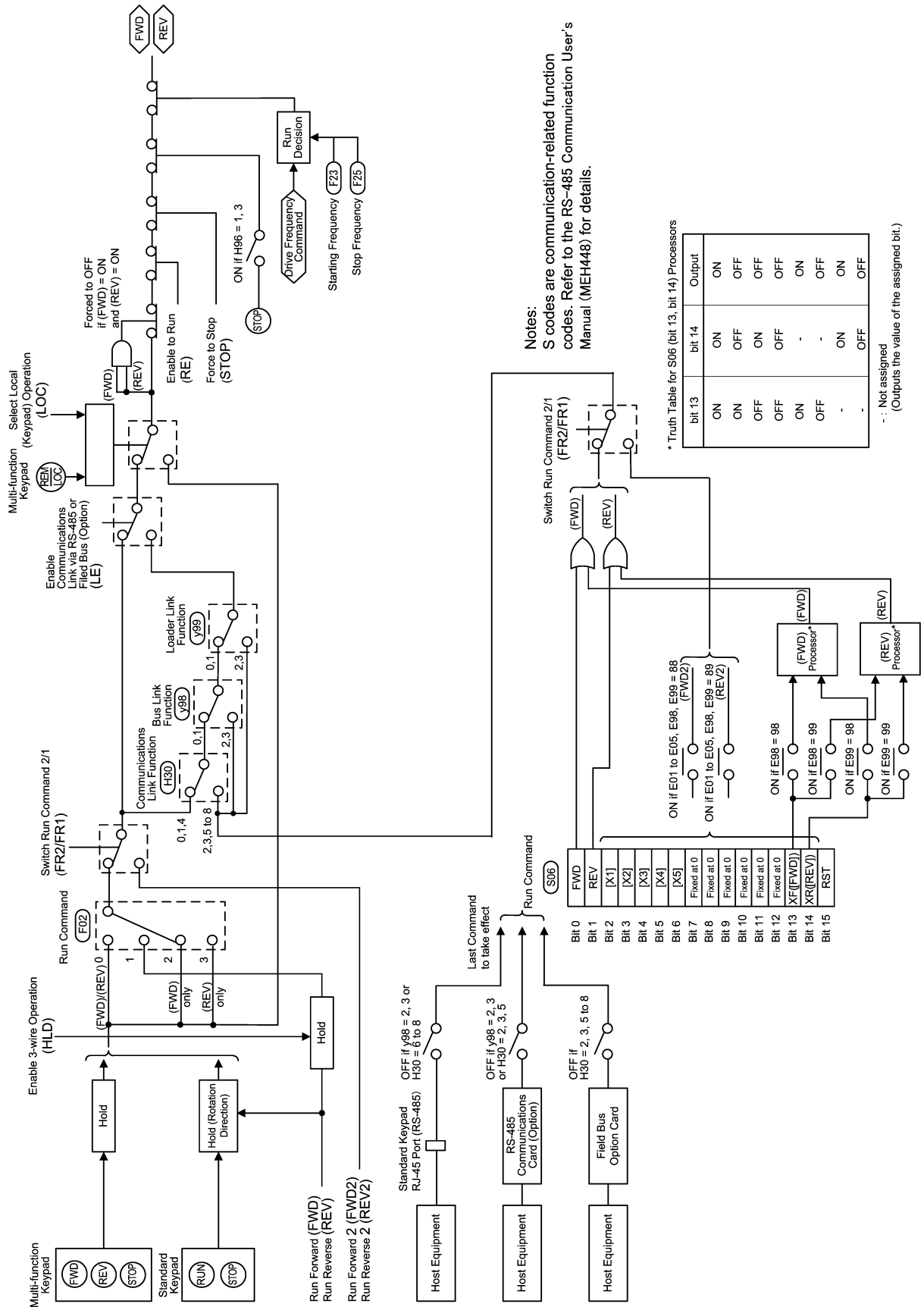

Figure 4.2 Block Diagram of Drive Command Generator

Figure 4.2 shows the processes that generate the final drive commands (FWD: Drive the motor in the forward direction and REV: Drive the motor in reverse direction) through the various run commands and switching steps by means of function codes.

Additional and supplemental information is given below.

- For the inverter operation given by the RUN / STOP key on the standard keypad, the generator holds the run command ON upon depression of the RUN key, decides the motor rotation direction according to the run forward command (FWD) or the run reverse command (REV), and releases the hold state upon depression of the STOP key.

For the inverter operation given by the $\text{FWD} / \text{REV} / \text{STOP}$ key on the multi-function keypad, the generator holds the command ON upon depression of the FWD / REV key, and releases the hold state upon depression of the STOP key.

- The 3-wire operation terminal command (HLD) holds the run forward terminal command (FWD) and the run reverse terminal command (REV). This allows you to run the inverter in "3-Wire Operation." Refer to the function code E01 in Chapter 9 "FUNCTION CODES" for details.

If you do not assign the 3-wire operation command (HLD) to any digital input terminals, the "2-Wire Operation" using the commands (FWD) and (REV) will take effect. Note that the (HLD) function does not apply to the run forward 2 (FWD2) and run reverse 2 (REV2) commands.

- S06 (2-byte data of bit 15 through bit 0, programmable bitwise), the operation command via the communications link, includes:
 - Bit 0: assigned to (FWD)
 - Bit 1: assigned to (REV)
 - Bit 13 (XF) and bit 14 (XR): Programmable bits equivalent to the terminal inputs [FWD] and [REV]

In the block diagram, all of these are denoted as operation commands. The data setting for function code E98 to select the function of terminal [FWD] and E99 of [REV] determine which bit value should be selected as the run command. If bits 13 and 14 have the same setting to select the function of (FWD) or (REV), the output of bit 13-14 processor logic will follow the truth table listed in Figure 4.2.

If either one of bits 13 and 14 is ON (= 1 as a logic value), the OR logic output will make the enable communications link command (LE) turn on. This is the same as with bit 0 and 1.

- If run commands (FWD) and (REV) are concurrently turned on, then logic forcibly makes the internal run command <FWD> or <REV> turn off.
- If you set data, 1 or 3, up to the function code H96 (STOP key priority/Start Check) to make the STOP key priority effective, then depressing the STOP key forcibly turns off the internal run commands <FWD> and <REV>. In this case, the generator automatically replaces deceleration characteristics of the inverter for that of the linear deceleration regardless of the setting of H07 (Acceleration/deceleration pattern).
- If the reference frequency is lower than the starting frequency (F23) or the stop frequency (F25), then the internal run commands will be finally turned off according to the output of run decision logic, and the inverter decelerates to stop the motor. (Refer to the final stage of the block diagram.)
- If you have assigned the "enable to run" terminal command (RE), giving any RUN command cannot start the motor unless turning (RE) on in advance.
- Upon giving the "select local (keypad) mode" terminal command (LOC) to select the keypad for a command source, or holding down the REM / LOC key on the multi-function keypad, the generator disables the command sources such as:
 - The run command source selected by the function code F02
 - The "switch run command 2/run command 1 (FR2/FR1)" and
 - The operation selection by the "enable communications link" command (LE)

The inverter operation is switched to the local run command issued by the RUN / STOP key on the standard keypad or the $\text{FWD} / \text{REV} / \text{STOP}$ key on the multi-function keypad. This command source switching operation also involves the frequency command source selected by the local keypad (E48). (Refer to Figure 4.1 "Block Diagram of Drive Frequency Command Generator.")

4.4 Digital Terminal Command Decoder

4.4.1 Terminals and related function codes

Table 4.2 shows a summary of relationship between digital control input terminals, those defined by a control string of the link command S06, and function codes to characterize them.

Table 4.2 Terminals and Related Function Codes

Terminal symbol	Bit assignment in the link command S06 (Control string)	Function code to characterize a digital input terminal
[X1]	Bit 2	E01
[X2]	Bit 3	E02
[X3]	Bit 4	E03
[X4]	Bit 5	E04
[X5]	Bit 6	E05
[FWD]	Bit 13	E98
[REV]	Bit 14	E99

Refer to the table on the next page for functions assigned to each terminal, and settings of function codes. Also refer to Chapter 9 "FUNCTION CODES" for details of function codes.

4.4.2 Functions assigned to digital control input terminals

Table 4.3 shows a summary of functions assigned to digital control input terminals. Refer to Chapter 9 "FUNCTION CODES" for details of the function code setting. Block diagrams shown on the succeeding pages differ with each other for every functional block.

Table 4.3 Functions Assigned to Digital Control Input Terminals

Function code data		Command assignment to terminals	Symbol
Active ON	Active OFF		
0	1000	Select multistep frequency	(SS1)
1	1001		(SS2)
2	1002		(SS4)
6	1006	Enable 3-wire operation	(HLD)
7	1007	Coast to a stop	(BX)
8	1008	Reset alarm	(RST)
1009	9	Enable external alarm trip	(THR)
11	1011	Switch frequency command 2/1	(Hz2/Hz1)
13	—	Enable DC brake	(DCBRK)
15	—	Switch to commercial power (50 Hz)	(SW50)
16	—	Switch to commercial power (60 Hz)	(SW60)
17	1017	UP (Increase output frequency)	(UP)
18	1018	DOWN (Decrease output frequency)	(DOWN)
19	1019	Enable write from keypad (Data changeable)	(WE-KP)
20	1020	Cancel PID control	(Hz/PID)
21	1021	Switch normal/inverse operation	(IVS)
22	1022	Interlock	(IL)
24	1024	Enable communications link via RS-485 or field bus (option)	(LE)
25	1025	Universal DI	(U-DI)
26	1026	Select starting characteristics	(STM)
1030	30	Force to stop	(STOP)
33	1033	Reset PID integral and differential components	(PID-RST)
34	1034	Hold PID integral component	(PID-HLD)
35	1035	Select local (keypad) operation	(LOC)
38	1038	Enable to run	(RE)
39	—	Protect motor from dew condensation	(DWP)
40	—	Enable integrated sequence to switch to commercial power (50 Hz)	(ISW50)
41	—	Enable integrated sequence to switch to commercial power (60 Hz)	(ISW60)
87	1087	Switch run command 2/1	(FR2/FR1)
88	—	Run forward 2	(FWD2)
89	—	Run reverse 2	(REV2)

4.4.3 Block diagrams for digital control input terminals

In the block diagrams for digital control input terminals, A [Terminal] should be replaced by [X1], [X2], [X3], [X4], [X5], [FWD] or [REV] depending on the function to be assigned.

Assign a function to a terminal by setting data of function codes E01 to E05, E98, and E99. Once a function is assigned to a terminal, "Select Input Terminal" shown in each block diagram is turned on.

If one and the same function is assigned to more than one terminals, the decoder logic ORs them so that if any of the input signal is turned on, the function signal output is turned on.

[1] Digital control input block (General)

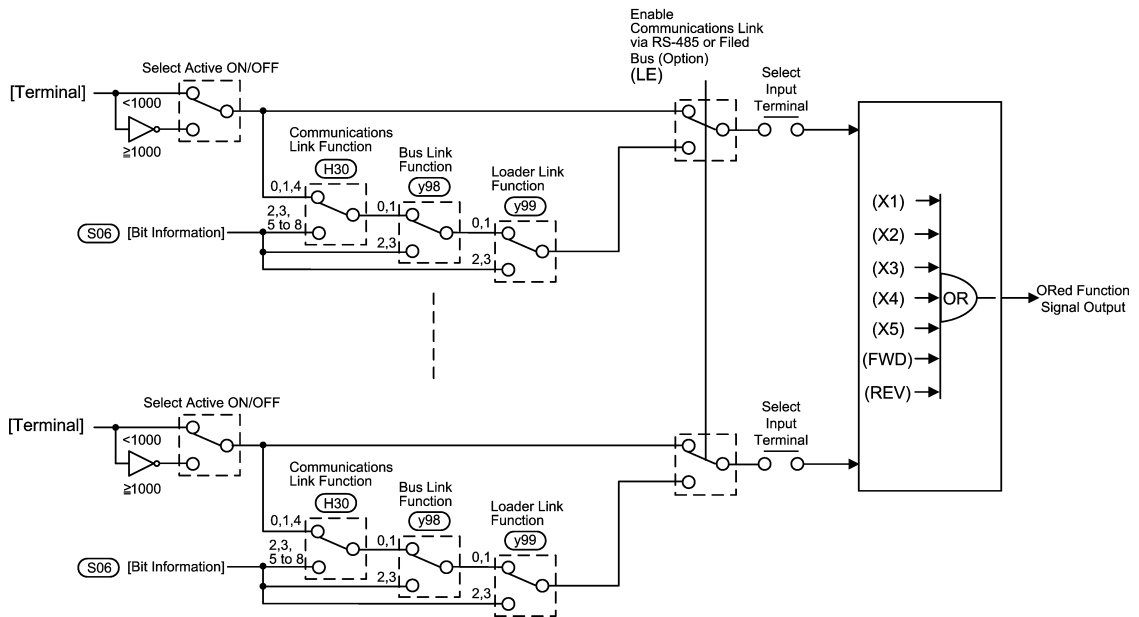

Figure 4.3 (a) Block Diagram of Digital Control Input Block (General)

Figure 4.3 (a) Digital Control Input Block (General) is a block diagram indicating the functions that switch external control signals between the digital input terminals and the control string (bit information) in S06 from the communications link.

[2] Digital control input block (Only for terminals)



Figure 4.3 (b) Block Diagram of Digital Control Input Block (Only for terminals)

Figure 4.3 (b) is a block diagram of the Digital Control Input Block (Only for terminals) that applies only to the digital terminal input functional block, which cannot use any control string from the communications link.

[3] Digital control input block (ORing the signals on terminals and the communications link)

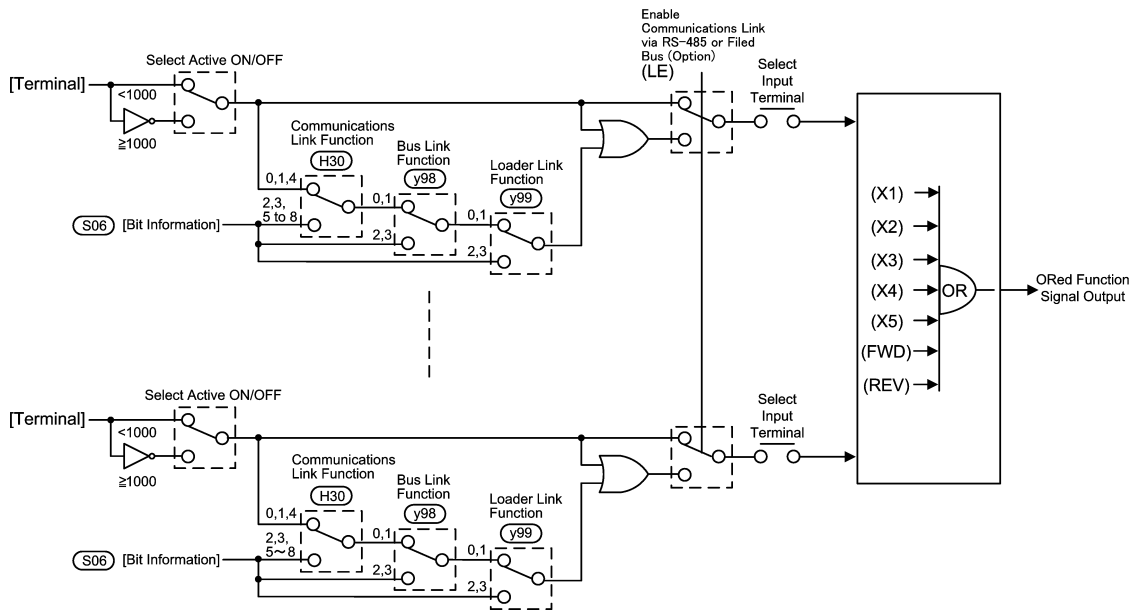

Figure 4.3 (c) Block Diagram of Digital Control Input Block (ORing the signals on terminals and communications link)

Figure 4.3 (c) is a block diagram of Digital Control Input Block (ORing the signals on terminals and communications link) that applies to the functional block of ORing (if any one signal being ON, the output turning ON) the input signals on terminals and the communications link.

[4] Digital control input block (Forced to turn off the signals on terminals during (LE) being turned on)

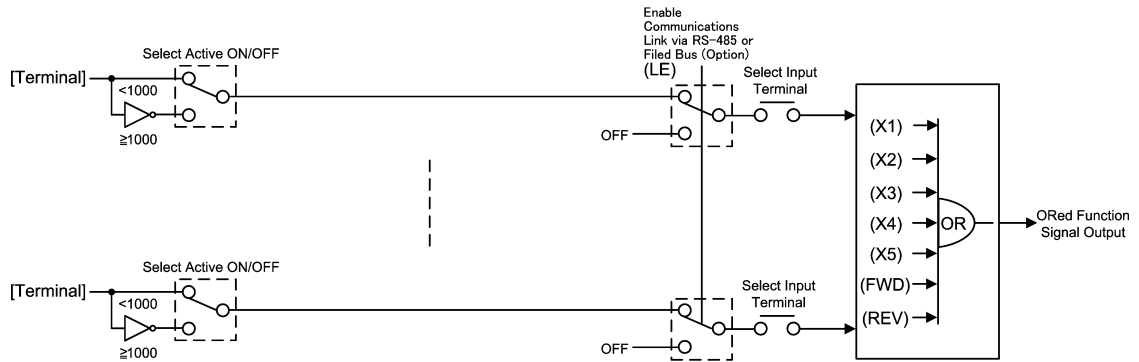

Figure 4.3 (d) Block Diagram of Digital Control Input Block (Forced to turn off the signals on terminals during (LE) being turned on)

Figure 4.3 (d) is a block diagram of the Digital Control Input Block (Forced to turn off the signals on terminals during the enable communications link command (LE) being turned on) that forces to turn off any signals on the digital input terminals during the communications link is activated ((LE) being turned on). Upon the "enable communications link" being disabled, the signals on the digital input terminals directly become the signal output for control.

[5] Assigning terminal functions via the communications link (Access to function code S06 exclusively reserved for the communications link)

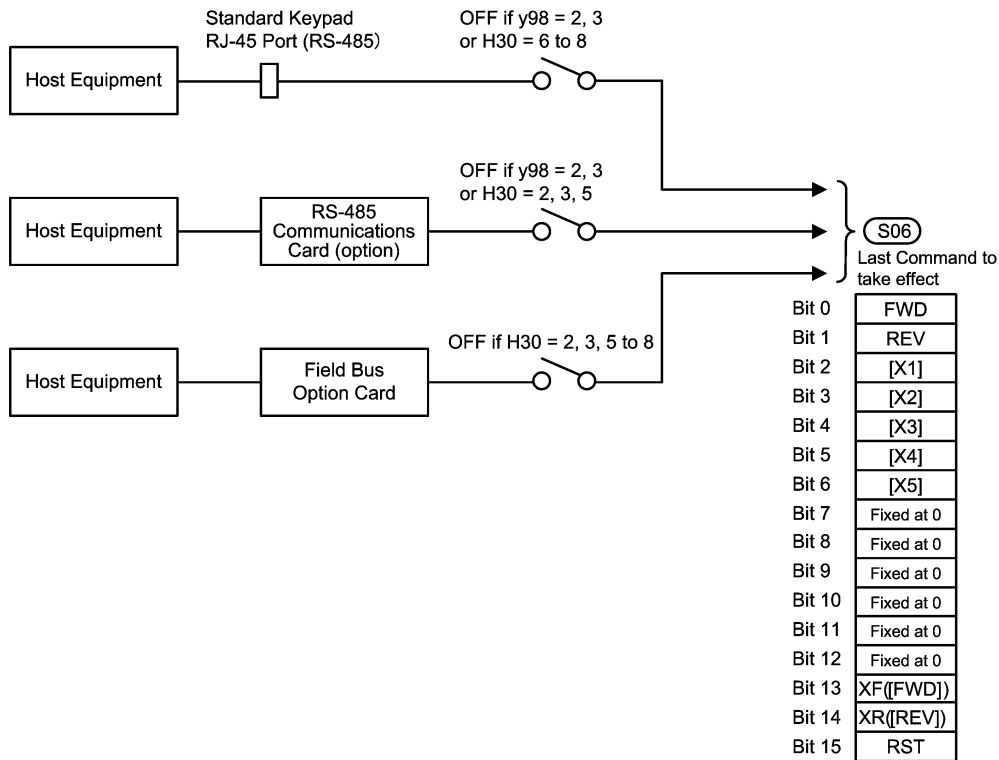

Figure 4.3 (e) Block Diagram of Digital Control Input Block (Commanding via communications link)

Similar to the Drive Command Generator explained in the Section 4.3, the command from the communications link is also available for characterizing the terminal functions. Any inverter can communicate with host equipment such as a personal computer and PLC (programmable logic controller), via the standard communications port for the keypad or the RS-485 card (option), using RS-485 communications protocol. Inverters can also communicate with host equipment via the field bus (option) using the FA protocol like DeviceNet.

As shown in Figure 4.3 (e), the terminal function is assigned to each bit of 16-bit string in S06 bitwise. Bit 2 to bit 6 (functionally equivalent to E01 to E05), bit 13 (equivalent to E98) and bit 14 (equivalent to E99) are available for characterizing of terminal functions. To enable the communications link for host equipment, use the function codes H30 and y98. For the field bus option, however, only use H30 to activate the communications link because the bus option does not support y98.

For details of communications, refer to Chapter 5 "RUNNING THROUGH RS-485 COMMUNICATION."

4.5 Digital Output Selector

4.5.1 Digital output components (Internal block)

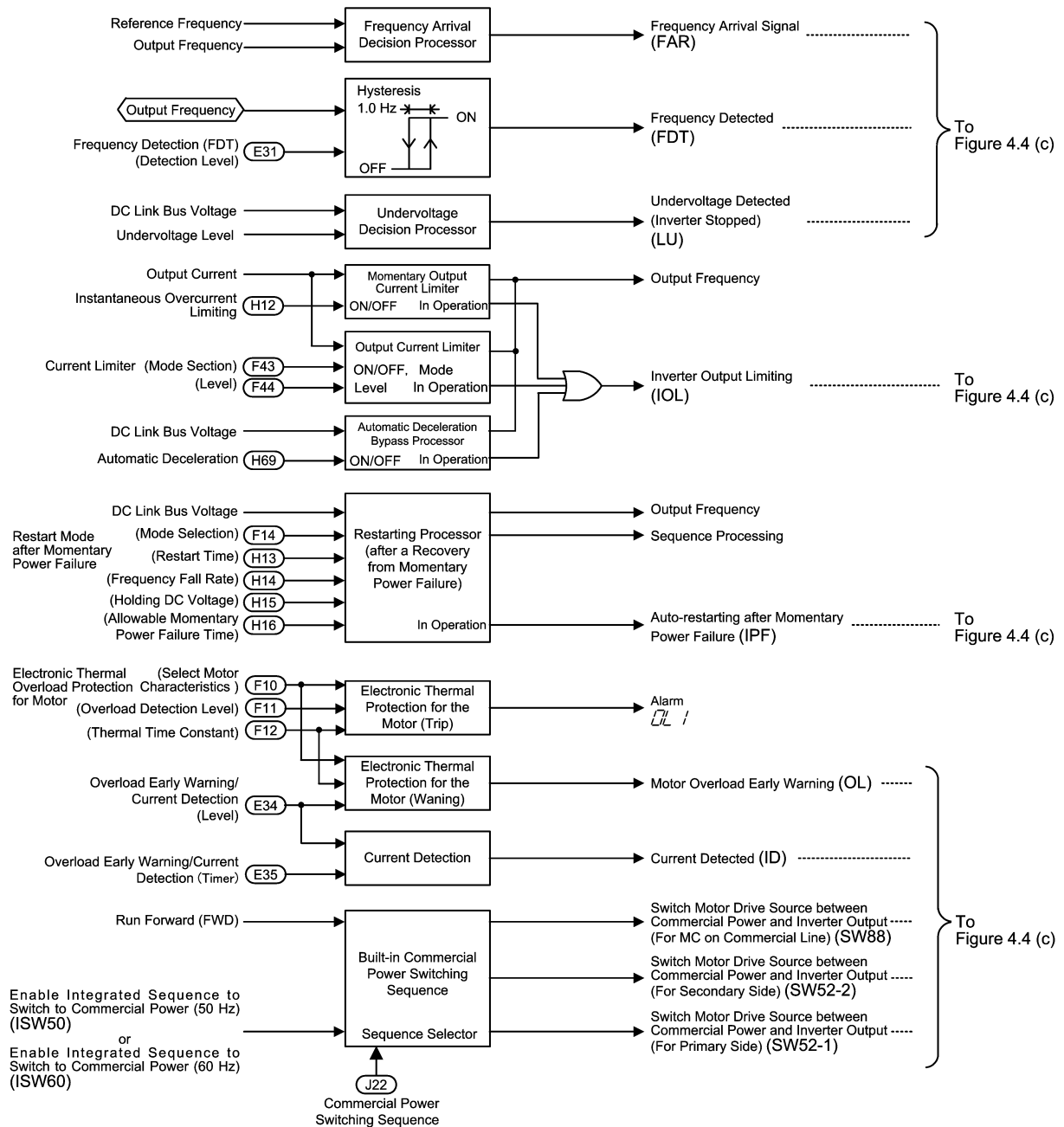

Figure 4.4 (a) Block Diagram of Digital Output Components (Internal block)

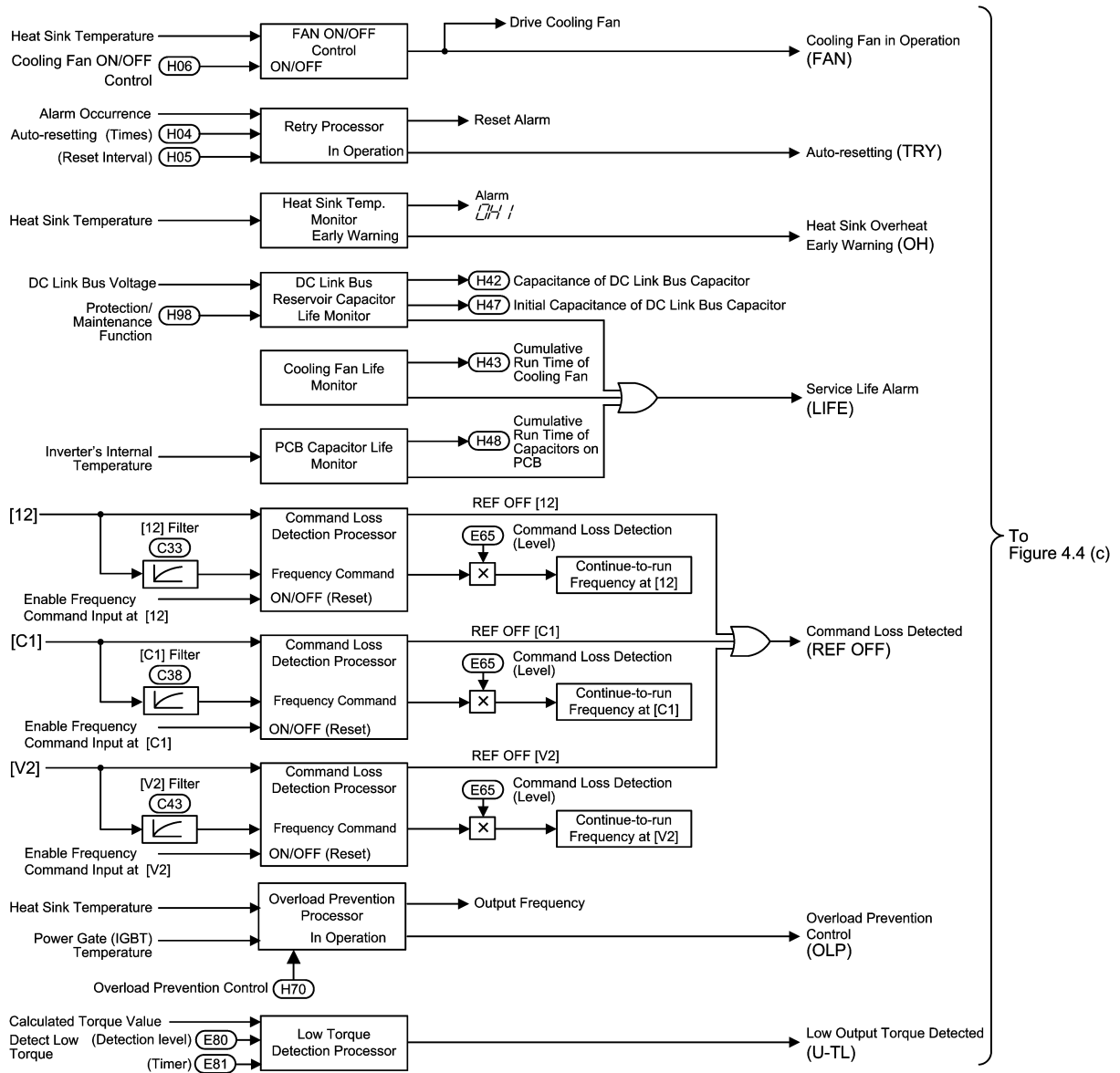

Figure 4.4 (b) Block Diagram of Digital Output Components (Internal block)

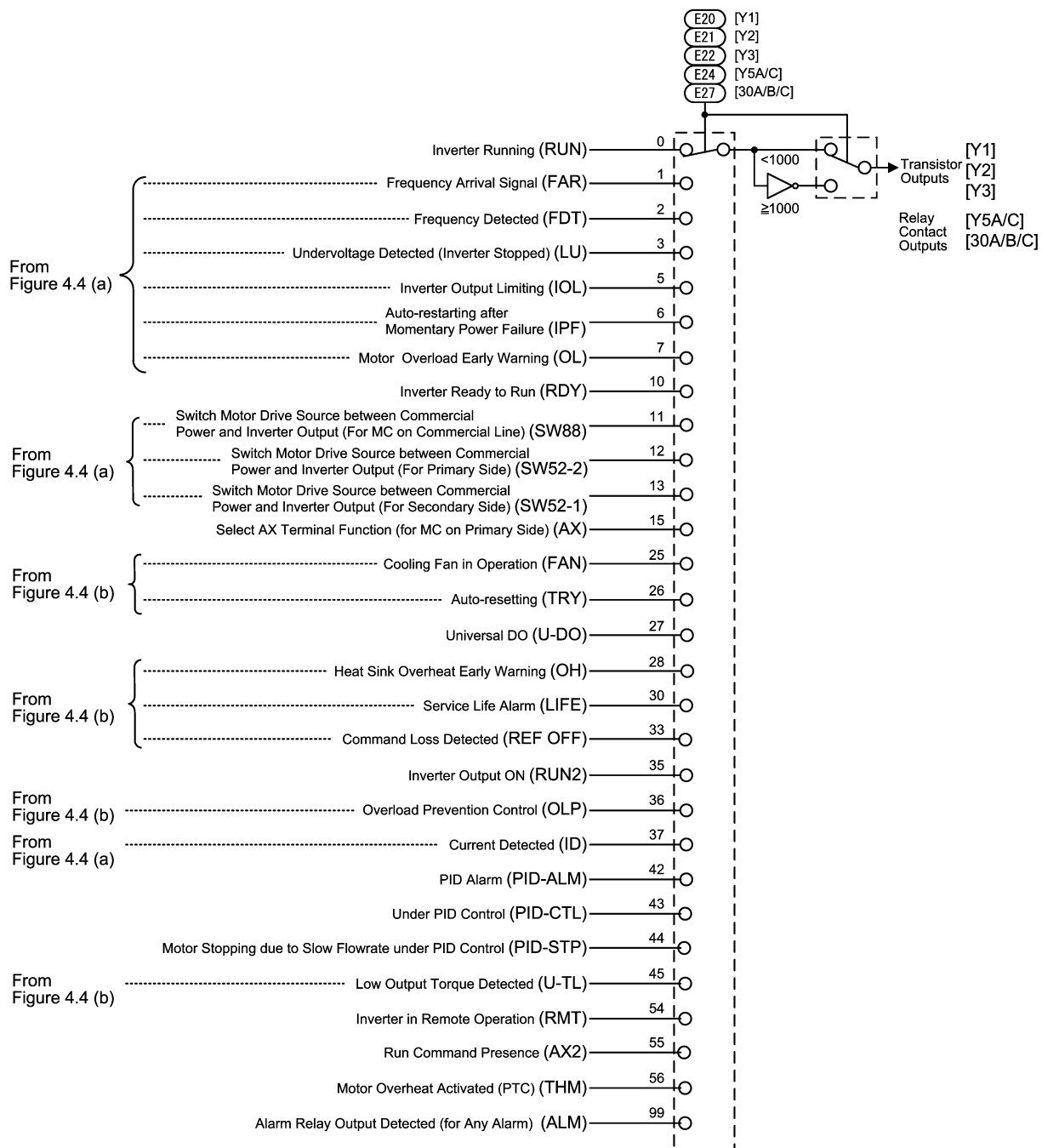

Figure 4.4 (c) Block Diagram of Digital Output Components (Final stage block)

The block diagrams shown in Figures 4.4 (a) to 4.4 (c) show you the processes to select the internal logic signals to generate five digital output signals at [Y1], [Y2], [Y3], [Y5A/C] and [30A/B/C]. Output terminals [Y1] to [Y3] (transistor outputs), [Y5A/C] and [30A/B/C] (mechanical relay contact outputs) are programmable terminals. You can assign various functions to these terminals using function codes E20 to E22, E24 and E27. Setting data of 1000s to the function code allows you to use these terminals for a negative logic system.

4.5.2 Universal DO (Access to the function code S07 exclusively reserved for the communications link)

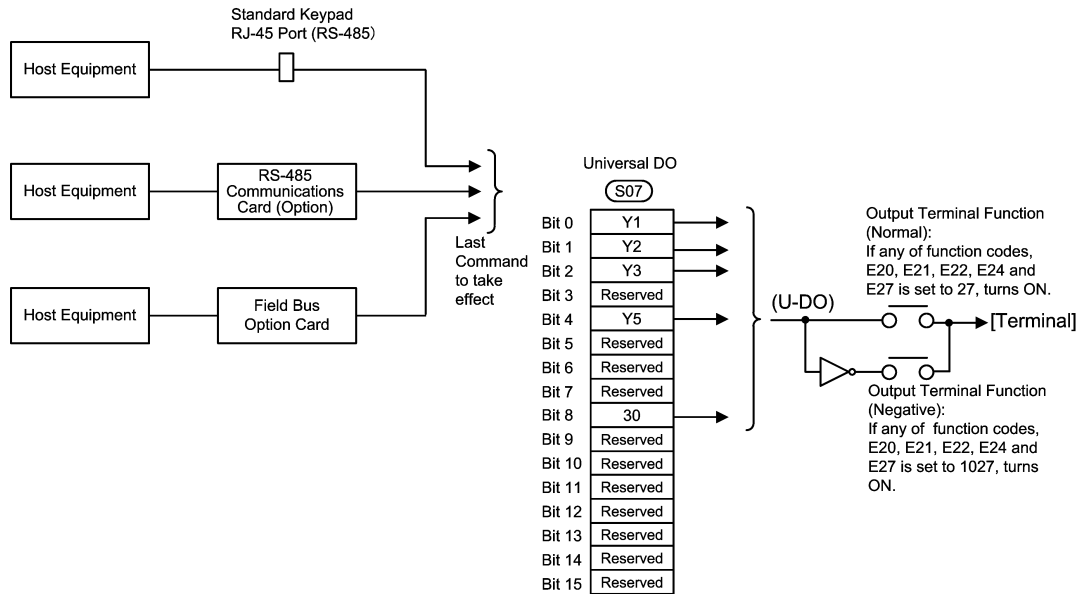

Figure 4.4 (d) Block Diagram of Universal DO

The universal DO is a feature that receives a signal from the host equipment via the communications link and outputs commands in ON/OFF format to the equipment connected to the inverter via the inverter's output terminals. To enable the feature, assign data "27" to one of function codes E20 to E22, E24 and E27 (for a negative logic system, set "1027"). For the 16-bit command string via the communications link, terminal and bit assignments are:

Bit 0 to bit 2 for output terminals [Y1] to [Y3] (transistor outputs) respectively

Bit 4 and bit 8 for output terminals [Y5A/C] and [30A/B/C] (relay contact outputs) respectively

4.6 Analog Output (FMA and FMI) Selector

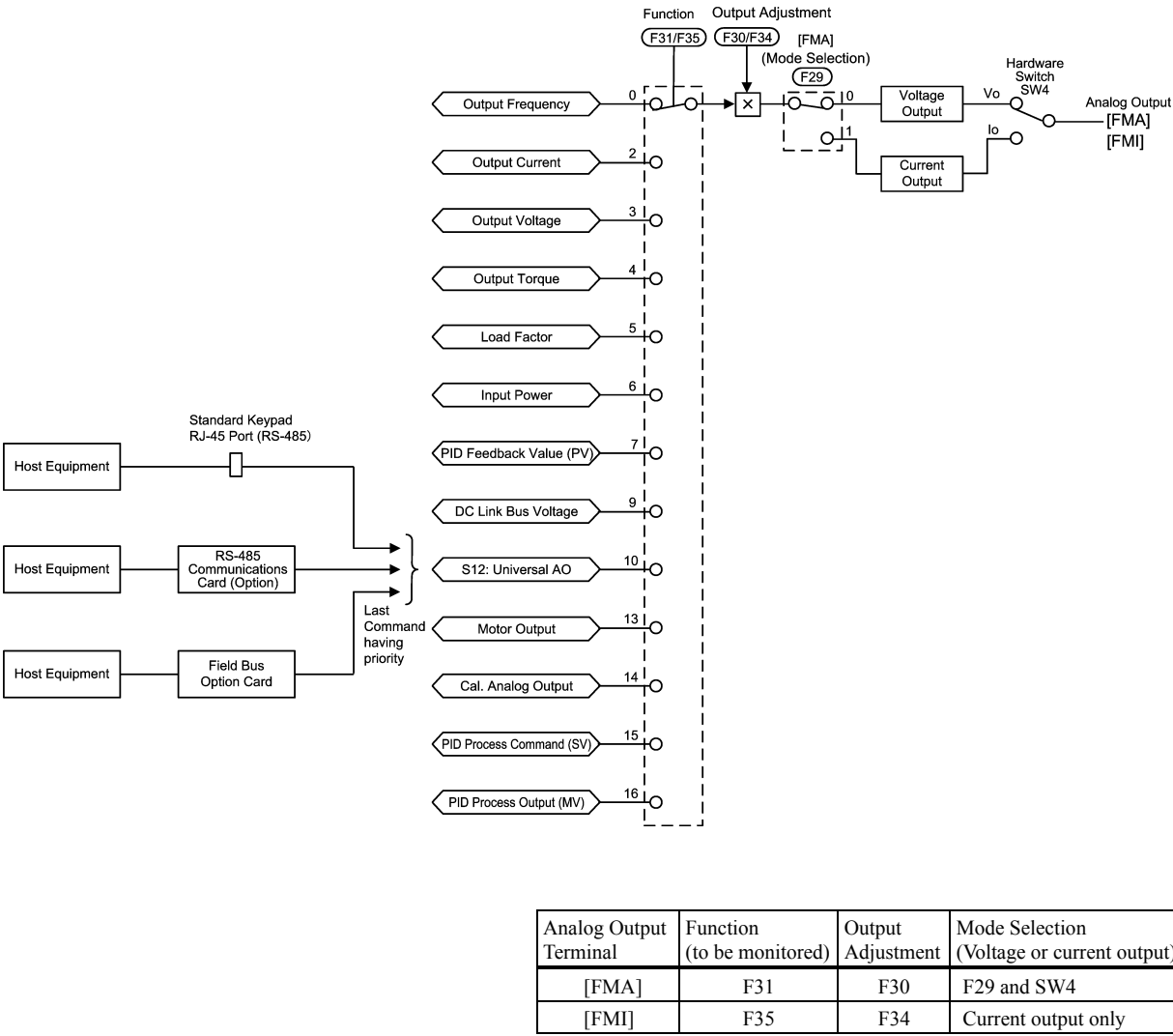

Figure 4.5 Block Diagram of Analog Output (FMA and FMI) Selector

The block diagram in Figure 4.5 shows the process for selecting and processing the internal signals to be output to analog output terminals [FMA] and [FMI]. Function code F31 or F35 determines what is output to [FMA] or [FMI], respectively. Function code F30 or F34 specifies the output value (%) for adjusting the full-scale of output signals to a level suitable for the indication of a meter connected to [FMA] or [FMI], respectively. Function code F29 and slide switch SW4 on the control PCB select the voltage or current output for [FMA].

Setting function code F31 or F35 to "10: Universal AO" enables data output from the host equipment via the communications link on [FMA] or [FMI], respectively.

The voltage output range is 0 to +10 V DC and the maximum allowable load current is 2 mA, so the inverter can drive up to two analog voltmeters with 10 V, 1 mA rating.

The current output range is +4 mA to +20 mA DC and the allowable load resistance is 500Ω or less.

The calibration analog output (F31 or F35 = 14) refers to an output of the [FMA]'s or [FMI]'s full-scale voltage or current that adjusts the scale of the connected meter.

4.7 Drive Command Controller

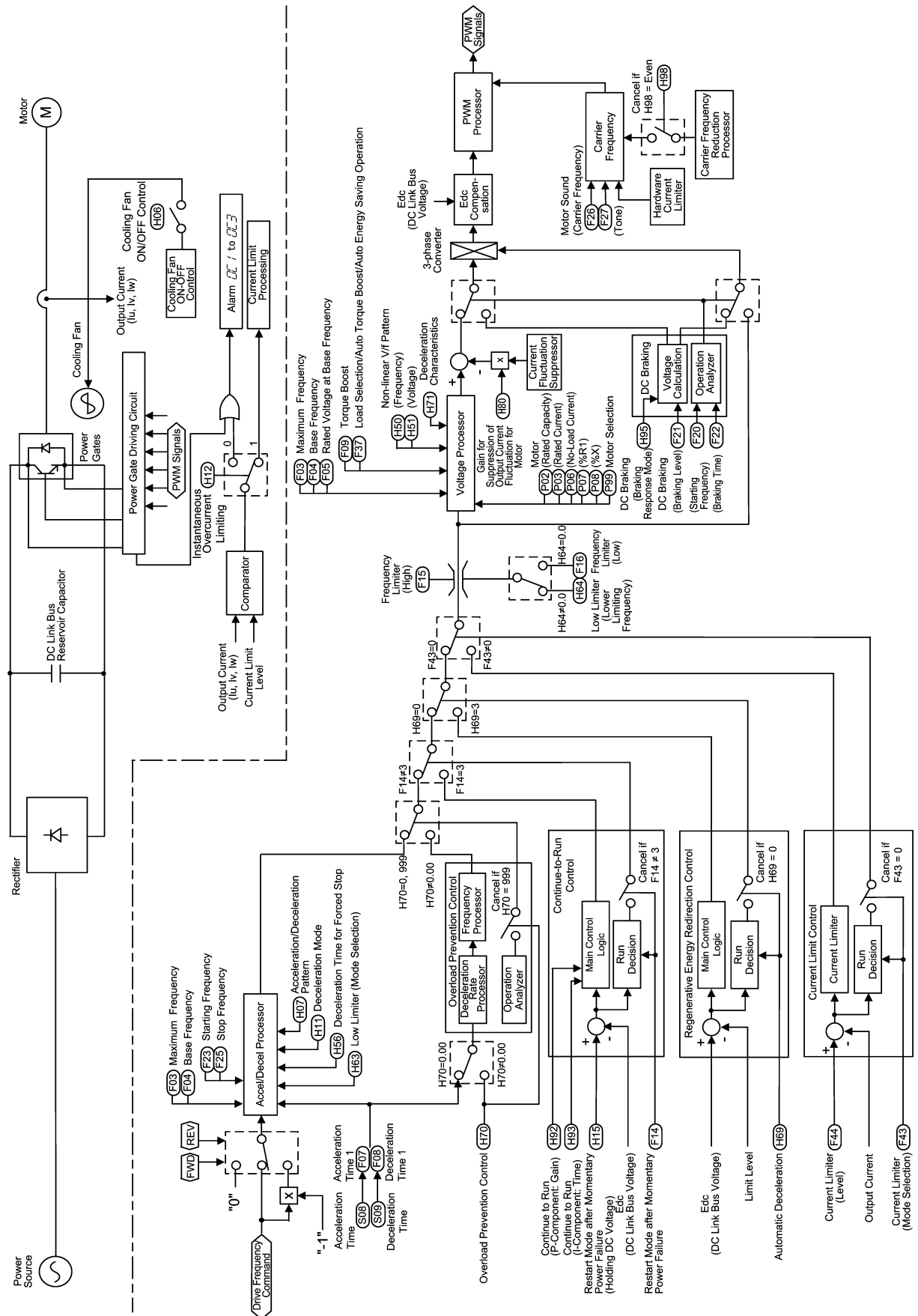

Figure 4.6 Block Diagram of Drive Command Controller and Related Part of the Inverter

Figure 4.6 is a schematic block diagram that explains the processes in which the inverter drives the motor according to the final run command <FWD> or <REV> and the <Drive Frequency Command> sent from the drive frequency command generator or the PID frequency command generator block.

Additional and supplemental information is given below.

- The logic shown in the upper left part of the block diagram processes the final reference frequency so that it is inverted ($\times(-1)$) for reverse rotation of the motor or is replaced with 0 (zero) for stopping the motor.
- The acceleration/deceleration processor determines the output frequency of the inverter by referring to data of related function codes. If the output frequency exceeds the upper limit given by the frequency limiter (High) (F15), the controller automatically limits the output frequency at the upper limit.
- If the overload prevention control is enabled, the logic automatically switches the output frequency to the enabled side of overload suppression control and controls the output frequency accordingly.
- If the current limiter is enabled ($F43 \neq 0$ and $H12 = 1$), the logic automatically switches the output frequency to the enabled side of the current limiting.
- The voltage processor determines the output voltage of the inverter. The processor adjusts the output voltage to control the motor output torque.
- If the DC braking control is enabled, the logic switches the voltage and frequency control components to the ones determined by the DC braking block to feed the proper DC current to the motor for the DC braking.
- If regenerative energy redirection control is enabled, the logic automatically controls the output frequency at the higher level, consequently prolongs the deceleration time (automatic deceleration).

4.8 PID Frequency Command Generator

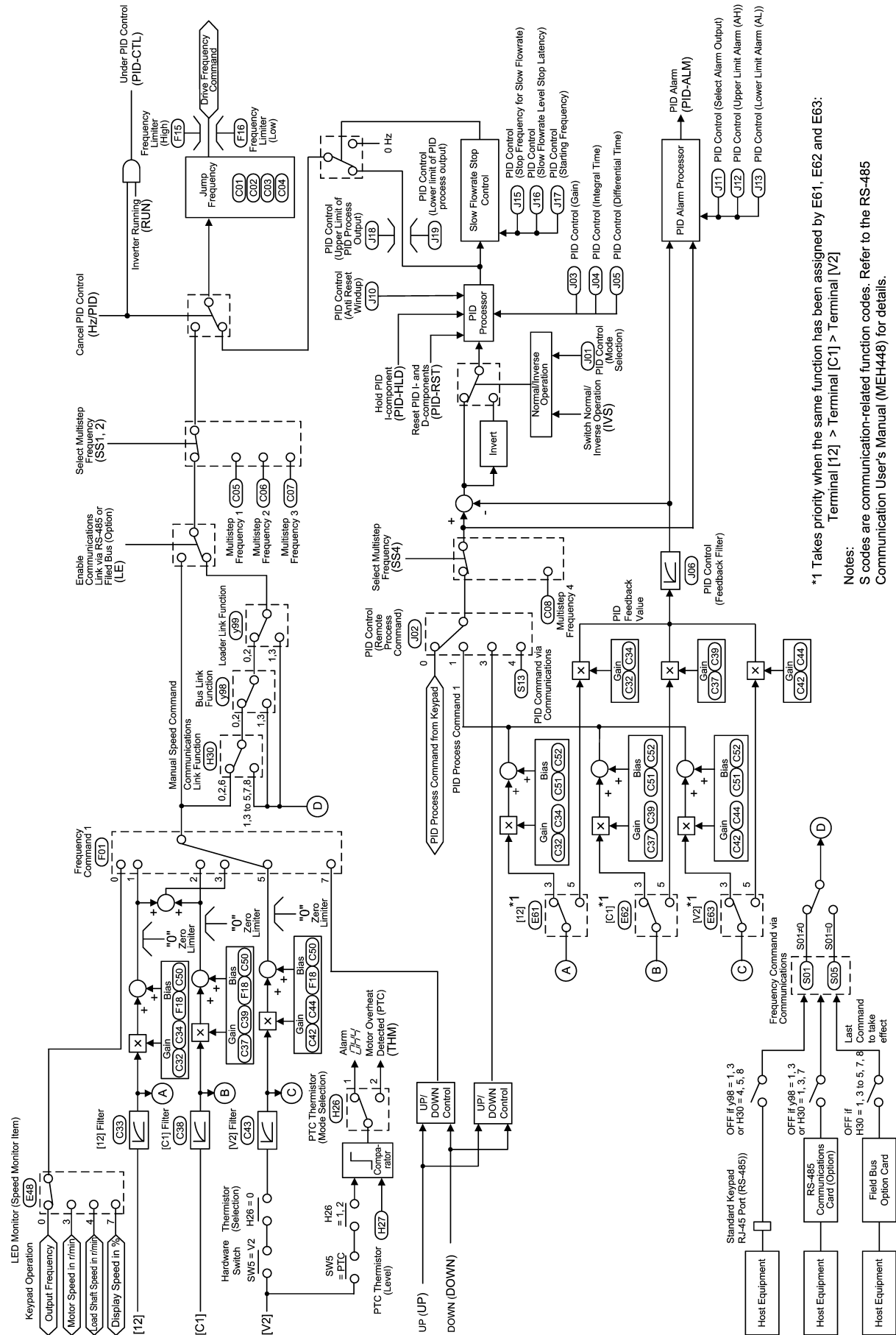

Figure 4.7 Block diagram of PID Frequency Command Generator

*1 Takes priority when the same function has been assigned by E61, E62 and E63:
Terminal [12] > Terminal [C1] > Terminal [V2]

Notes:
S codes are communication-related function codes. Refer to the RS-485 Communication User's Manual (MEH448) for details.

Figure 4.7 shows a block diagram of the PID frequency command generator when the PID control is enabled (J01= 1 or 2). The logic shown generates the <drive frequency command> according to the PID process command source and PID feedback source, PID conditioner, and the selected frequency command source for a manual speed command.

Additional and supplemental information is given below.

- Selection of the frequency command source 2 (C30) and the auxiliary frequency command source 1 and 2 (E61 to E63) as a manual speed command are disabled under the PID control.
- The multistep frequency commands 1 and 2 are only applicable to the manual speed command.
- For selecting analog input (terminal [12], [C1], or [V2]) as the PID process command source, you need to set data up for function codes E61 to E62 and J02.
- The multistep frequency command 4 (C08) selected by (SS4) is only applicable to PID process command.
- To switch the operation between normal and inverse, the logic inverses the polarity of difference between the PID command and its feedback (turning the (INV) command on/off, or setting data J01 at 1 or 2).
- Refer to Section 4.2 " Drive Frequency Command Generator" for explanations of common items.
- When the inverter has entered the process of stopping the motor due to slow flowrate under PID control, if any of conditions determined by function codes J15, J16 and J17 is taken, the slow flowrate stop control logic forces to switch the PID output (<drive frequency command>) to 0 Hz to stop the inverter output. For details, refer to function codes J15, J16 and J17 in Chapter 9, Section 9.2.6 "J codes (Application functions)."

Chapter 5

RUNNING THROUGH RS-485 COMMUNICATION

This chapter describes an overview of inverter operation through the RS-485 communications facility. Refer to the RS-485 Communication User's Manual (MEH448) for details.

Contents

5.1	Overview on RS-485 Communication	5-1
5.1.1	RS-485 common specifications (standard and optional)	5-2
5.1.2	RJ-45 connector pin assignment for standard RS-485 communications port.....	5-3
5.1.3	Pin assignment for optional RS-485 Communications Card	5-4
5.1.4	Cable for RS-485 communications port.....	5-4
5.1.5	Communications support devices	5-5
5.2	Overview of FRENIC Loader	5-6
5.2.1	Specifications	5-6
5.2.2	Connection	5-7
5.2.3	Function overview.....	5-7
5.2.3.1	Setting of function code.....	5-7
5.2.3.2	Multi-monitor	5-8
5.2.3.3	Running status monitor.....	5-9
5.2.3.4	Test-running.....	5-10
5.2.3.5	Real-time trace—Displaying running status of an inverter in waveforms	5-11

5.1 Overview on RS-485 Communication

Removing the built-in keypad from your FRENIC-Eco inverter and using the standard RJ-45 connector (modular jack) for it as an RS-485 communications port brings about the following enhancements in functionality and operation:

■ Operation from a keypad at the remote location

You can use your built-in keypad or an optional multi-function keypad as a remote keypad by connecting it to the RJ-45 port by means of an extension cable. You may mount it on a panel of the conveniently located control panel for easy access. The maximum length of the extension cable is 20 m.

■ Operation by FRENIC Loader

The Windows-based PC can be connected to the standard RS-485 communications port via a suitable converter. Through the RS-485 communications facility, you may run FRENIC Loader on the PC to edit the function code data and monitor the running status information of the inverter.

■ Control via a host equipment

You can use a personal computer (PC) or a PLC as host (higher-level) equipment and through it control the inverter as its subordinate device.

Protocols for managing a network including inverters include the Modbus RTU protocol (compliant to the protocol established by Modicon Inc.) that is widely used in FA markets and the Fuji general-purpose inverter protocol that supports the FRENIC-Eco and conventional series of inverters.

 When you use a remote keypad, the inverter automatically recognizes it and adopts the keypad protocol; there is no need to modify the function code setting.

When using FRENIC Loader, which requires a special protocol for handling Loader commands, you need to set up some communication function codes accordingly.

For details, refer to the FRENIC Loader Instruction Manual (INR-SI47-0903-E).

Further, you can add another RS-485 communications port by installing an optional RS-485 Communications Card onto the printed circuit board inside your FRENIC-Eco inverter. This additional communications link can be used only as the port for host equipment; you cannot use it as the communications port for a remote keypad or FRENIC Loader.

 For details of RS-485 communication, refer to the RS-485 Communication User's Manual (MEH448).

5.1.1 RS-485 common specifications (standard and optional)

Items	Specifications		
Protocol	FGI-BUS	Modbus RTU	Loader commands (supported only on the standard version)
Compliance	Fuji general-purpose inverter protocol	Modicon Modbus RTU-compliant (only in RTU mode)	Dedicated protocol (Not disclosed)
No. of supporting stations	Host device: 1 Inverters: Up to 31		
Electrical specifications	EIA RS-485		
Connection to RS-485	8-pin RJ-45 connector (standard) or terminal block (optional)		
Synchronization	Asynchronous start-stop system		
Transmission mode	Half-duplex		
Transmission speed	2400, 4800, 9600 19200 or 38400 bps		
Max. transmission cable length	500 m		
No. of logical station addresses available	1 to 31	1 to 247	1 to 255
Message frame format	FGI-BUS	Modbus RTU	FRENIC loader
Frame synchronization	Detection SOH (Start Of Header) character	Detection of no-data transmission time for 3-byte period	Start code 96H detection
Frame length	Normal transmission: 16 bytes (fixed) High-speed transmission: 8 or 12 bytes	Variable length	Variable length
Max. transfer data	Write: 1 word Read: 1 word	Write: 50 words Read: 50 words	Write: 41 words Read: 41 words
Messaging system	Polling/Selecting/Broadcast		Command message
Transmission character format	ASCII	Binary	Binary
Character length	8 or 7 bits (selectable by the function code)	8 bits (fixed)	8 bits (fixed)
Parity	Even, Odd, or None (selectable by the function code)		Even (fixed)
Stop bit length	1 or 2 bits (selectable by the function code)	No parity: 2 bits Even or Odd parity: 1 bit	1 bit (fixed)
Error checking	Sum-check	CRC-16	Sum-check

5.1.2 RJ-45 connector pin assignment for standard RS-485 communications port

The port designed for a standard keypad uses an RJ-45 connector having the following pin assignment:

Pin	Signal name	Function	Remarks
1 and 8	Vcc	Power source for the keypad	5V power lines
2 and 7	GND	Reference voltage level	Grounding pins
3 and 6	NC	Not used.	No connection
4	DX-	RS-485 data (-)	Built-in terminator: 112Ω
5	DX+	RS-485 data (+)	Open/close by SW3*

* For details about SW3, refer to "[Setting up the slide switches](#)" in Section 8.3.1 "Terminal functions."

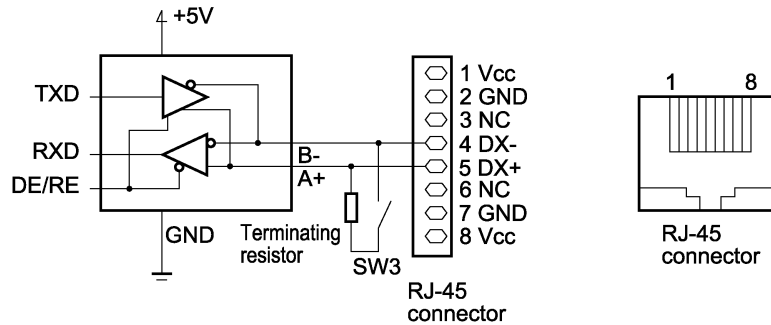

Pins 1, 2, 7, and 8 on the RJ-45 connector are exclusively assigned to power supply and grounding for keypads. When connecting other devices to the RJ-45 connector, take care not to use those pins. Failure to do so may cause a short-circuit hazard.

5.1.3 Pin assignment for optional RS-485 Communications Card

The RS-485 Communications Card has two sets of pins for multi-drop connection as listed below.

Terminal symbol	Terminal name	Function description	
1 (standard)	DX+	RS-485 communications data (+) terminal	This is the (+) terminal of RS-485 communications data.
	DX-	RS-485 communications data (-) terminal	This is the (-) terminal of RS-485 communications data.
	SD	Communications cable shield terminal	This is the terminal for relaying the shield of the shielded cable, insulated from other circuits.
2 (for relay)	DX+	DX+ relay terminal	This is the relay terminal of RS-485 communications data (+).
	DX-	DX- relay terminal	This is the relay terminal of RS-485 communications data (-).
	SD	SD relay terminal	This is the terminal for relaying the shield of the shielded cable, insulated from other circuits.

SW103 is provided on the RS-485 Communications Card for connecting or disconnecting the terminating resistor (112Ω). For the location of SW103, refer to the RS-485 Communications Card "OPC-F1-RS" Installation Manual (INR-SI47-0872).

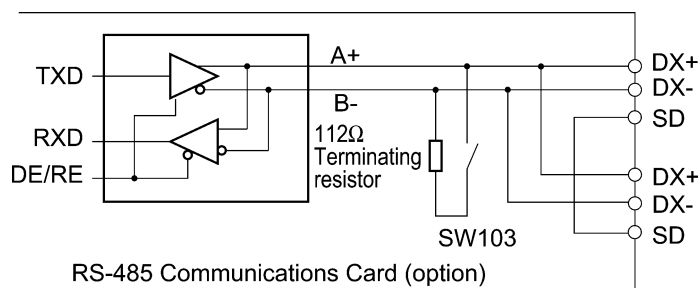

5.1.4 Cable for RS-485 communications port

For connection with the RS-485 communications port, be sure to use an appropriate cable and a converter that meet the applicable specifications.

 For details, refer to the RS-485 Communication User's Manual (MEH448).

5.1.5 Communications support devices

This section provides information necessary for connection of the inverter to host equipment having no RS-485 communications port such as a PC or for configuring a multi-drop connection.

[1] Communications level converter

Most personal computers (PC) are not equipped with an RS-485 communications port but RS-232C and USB ports. To connect a FRENIC-Eco inverter to a PC, therefore, you need to use an RS-232C–RS-485 communications level converter or a USB–RS-485 interface converter. For correct running of the communications facility to support FRENIC-Eco series of inverters, be sure to use one of the recommended converters listed below.

Recommended converters

KS-485PTI (RS-232C–RS-485 communications level converter)

USB-485I RJ45-T4P (USB–RS-485 interface converter)

Supplied by SYSTEM SACOM Corporation.

[2] Requirements for the cable

Use an off-the-shelf 10BASE-T/100BASE-TX LAN cable (ANSI/TIA/EIA-568A category 5 compliant, straight type).



The RJ-45 connector has power source pins (pins 1, 2, 7 and 8) exclusively assigned for keypads. When connecting other devices to the RJ-45 connector, take care not to use those pins. Failure to do so may cause a short-circuit hazard.

[3] Multi-drop adapter

To connect a FRENIC-Eco inverter to a network in a multi-drop configuration with a LAN cable that has RJ-45 as the communications connector, use a multi-drop adapter for the RJ-45 connector.

Recommended multi-drop adapter

Model MS8-BA-JJJ made by SK KOHKI Co., Ltd.

[4] RS-485 Communications Card

To equip your inverter with another RS-485 communications port in addition to the standard RS-485 communications port, you need to install this optional card. Note that you cannot use FRENIC Loader through the optional RS-485 communications port.

RS-485 Communications Card (option)

For details, refer to the RS-485 Communications Card Option "OPC-F1-RS" Installation Manual (INR-SI47-0872).



For more details through Section 5.1.5, refer to the RS-485 Communication User's Manual (MEH448).

5.2 Overview of FRENIC Loader

FRENIC Loader is a software tool that supports the operation of the inverter via an RS-485 communications link. It allows you to remotely run or stop the inverter, edit, set, or manage the function codes, monitor key parameters and values during operation, as well as monitor the running status (including alarm information) of the inverters on the RS-485 communications network.

 For details, refer to the FRENIC Loader Instruction Manual (INR-SI47-0903-E).

5.2.1 Specifications

Item		Specifications (White on black indicates factory default)	Remarks
Name of software		FRENIC Loader Ver. 2.0.1.0 or later	
Supported inverter		FRENIC-Eco series FRENIC-Mini series	(Note 1)
No. of supported inverters		Up to 31	
Recommended cable		10BASE-T cable with RJ-45 connectors compliant with EIA568	
Operating environment	CPU	Intel Pentium 200 MHz with MMX or later	(Note 2)
	OS	Microsoft Windows 98 Microsoft Windows 2000 Microsoft Windows XP	
	Memory	32 MB or more RAM	64 MB or more is recommended
	Hard disk	5 MB or more free space	
	COM port	RS-232C or USB	Conversion to RS-485 communication required to connect inverters
	Monitor resolution	SVGA (800 x 600) or higher	1024 x 768, 16-bit color or higher is recommended
Transmission requirements	COM port	, COM2, COM3, COM4, COM5, COM6, COM7, COM8	PC COM ports assigned to Loader
	Transmission rate	38400, , 9600, 4800 and 2400 bps	19200 bps or more is recommended. (Note 3)
	Character length		Prefixed
	Stop bit length		Prefixed
	Parity		Prefixed
	No. of retries	None or to 10	No. of retry times before detecting communications error
Timeout setting	(100 ms, 300 ms, 500 ms), (to 9.0 s) or (10.0 to 60.0 s)	This setting should be longer than the response interval time set by function code y09 of the inverter.	

(Note 1) FRENIC Loader cannot be used with inverters that do not support SX protocol (protocol for handling Loader commands).

With special order-made inverters, FRENIC Loader may not be able to display some function codes normally.

To use FRENIC Loader on FRENIC-Mini series of inverters, an RS-485 Communications Card (Option: OPC-C1-RS) is required.

- (Note 2) Use a PC with as high a performance as possible, since some slow PCs may not properly refresh the operation status monitor and Test-run windows.
- (Note 3) To use FRENIC Loader on a network where a FRENIC-Mini inverter is also configured, choose 19200 bps or below.

5.2.2 Connection

By connecting a number of inverters to one PC, you can control one inverter at a time or a number of inverters simultaneously through multiple windows on the PC. You can also simultaneously monitor multiple inverters on a single screen.

 For how to connect a PC to one or more inverters, refer to the RS-485 Communication User's Manual (MEH448).

5.2.3 Function overview

5.2.3.1 Setting of function code

You can set, edit, and checkout the setting of the inverter's function code data.

Function code edit (List and Edit)

In List and edit, you can list and edit function codes with function code No., name, set value, set range, and factory default.

You can also list function codes by any of the following groups according to your needs:

- Function code group
- Function codes that have been modified from their factory defaults
- Result of comparison with the settings of the inverter
- Result of search by function code name
- User-specified function code set

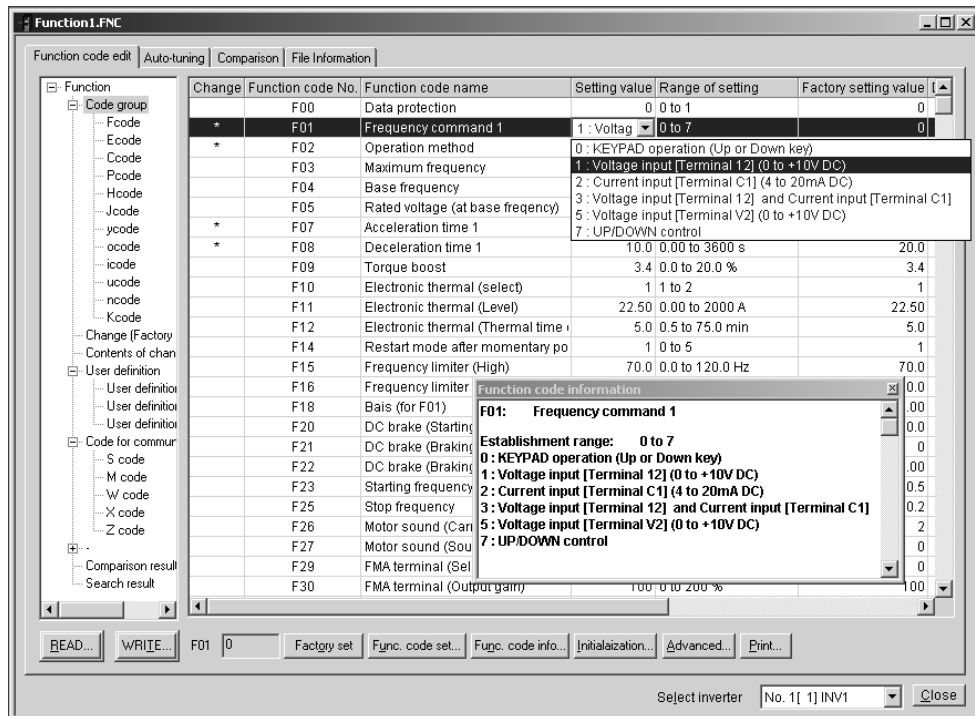

Comparison

You can compare the function code data currently being edited with that saved in a file or stored in the inverter.

To perform a comparison and review the result displayed, click the **Comparison** tab and then click the **Compared with inverter** tab or click the **Compared with file** tab, and specify the file name.

The result of the comparison will be displayed also in the Comparison Result column of the list.

File information

Clicking the **File information** tab displays the property and comments for identifying the function code editing file.

(1) Property

Shows file name, inverter model, inverter's capacity, date of readout, etc.

(2) Comments

Displays the comments you have entered. You can write any comments necessary for identifying the file.

5.2.3.2 Multi-monitor

This feature lists the status of all the inverters that are marked "connected" in the configuration table.

Multi-monitor

Allows you to monitor the status of more than one inverter in a list format.

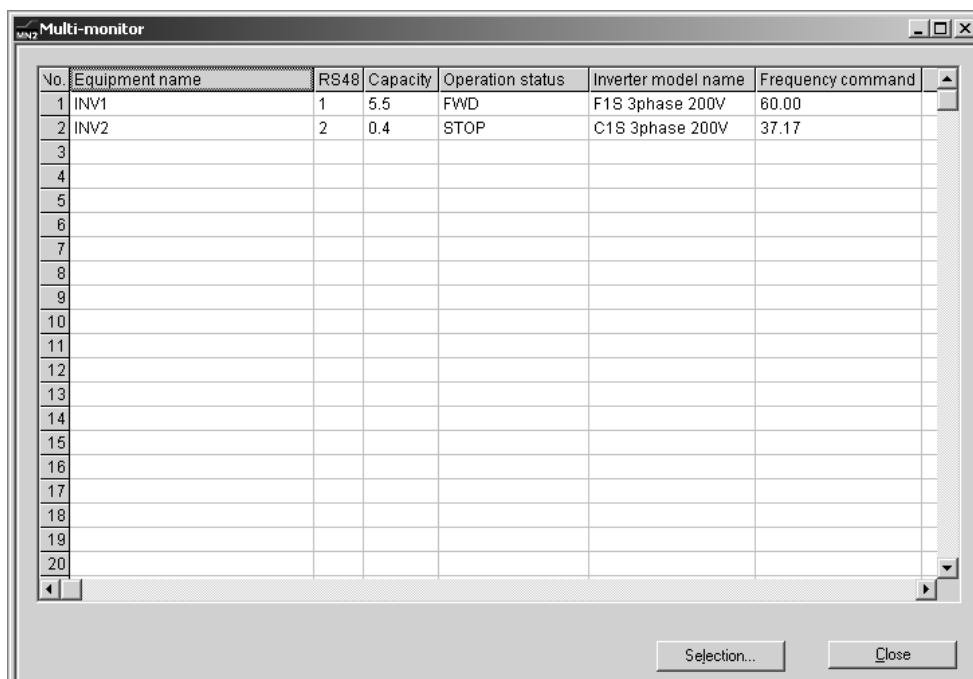

The screenshot shows a window titled "Multi-monitor" with a table containing the following data:

No.	Equipment name	RS48	Capacity	Operation status	Inverter model name	Frequency command
1	INV1	1	5.5	FWD	F1S 3phase 200V	60.00
2	INV2	2	0.4	STOP	C1S 3phase 200V	37.17
3						
4						
5						
6						
7						
8						
9						
10						
11						
12						
13						
14						
15						
16						
17						
18						
19						
20						

At the bottom of the window, there are two buttons: "Selection..." and "Close".

5.2.3.3 Running status monitor

The running status monitor offers four monitor functions: I/O monitor, System monitor, Alarm monitor, and Meter display. You can choose an appropriate monitoring format according to the purpose and situation.

I/O monitor

Allows you to monitor the ON/OFF states of the digital input signals to the inverter and the transistor output signals.

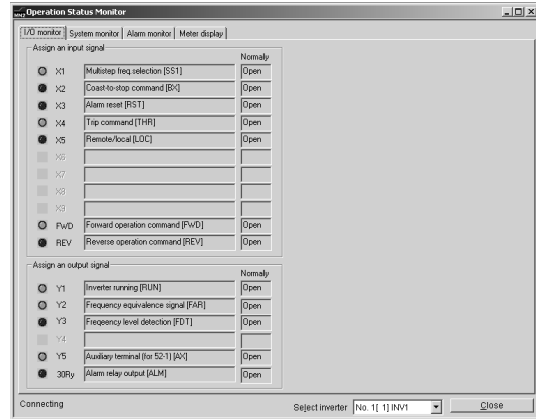

System monitor

Allows you to check the inverter’s system information (version, model, maintenance information, etc.).

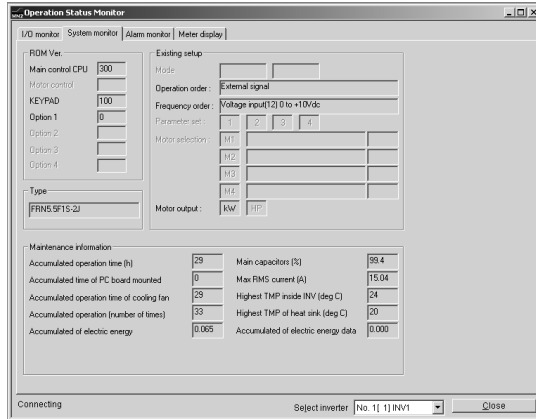

Alarm monitor

The alarm monitor shows the alarm status of the selected inverter. In this window you can check the details of the alarm currently occurs and related information.

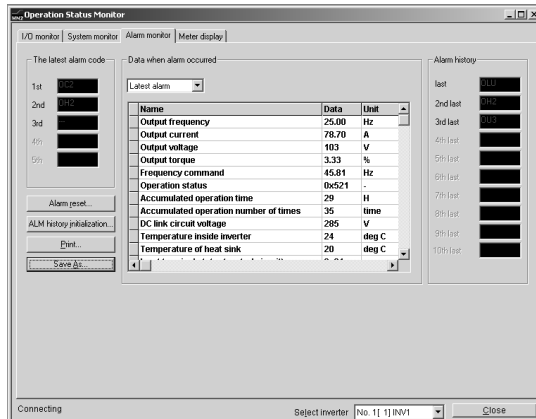

Meter display

Displays analog readouts of the selected inverter (such as output frequency) on analog meters. The example on the right displays the reference frequency and the output frequency.

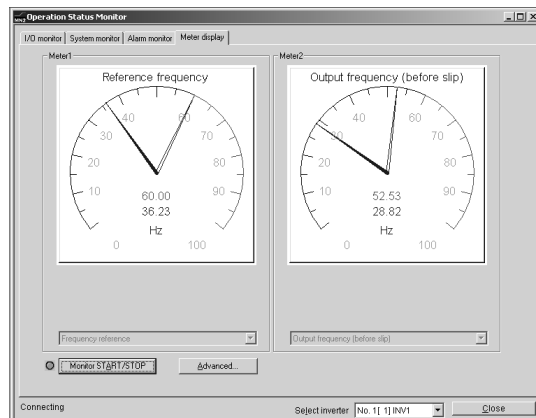

5.2.3.4 Test-running

The Test-running feature allows you to test-run the motor in "Run forward" or "Run reverse" while monitoring the running status of the selected inverter.

Select monitor item

Select what is to be displayed here from output frequency, current, etc.

Setting frequency command

Enter or select the set frequency command to write it into the inverter. Click **Apply** to make it effective.

I/O terminal status

Shows status of the programmable I/O terminals of the inverter.

Indicating Operation status

Shows FWD, REV, STOP and Alarm codes.

Operation buttons*

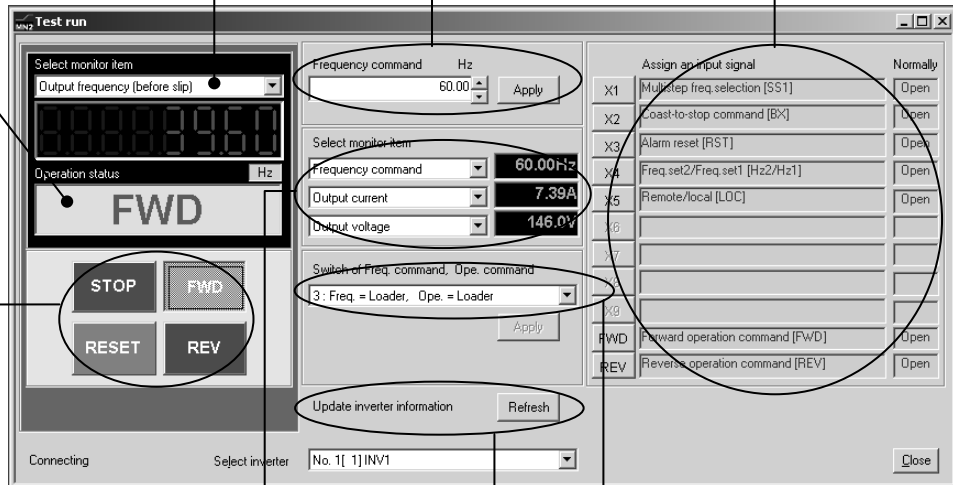

Selecting monitor item

Select the operation status information to be monitored real-time.

Update the inverter info for the latest ones

Click the Refresh button to update running status of the inverter shown on the Loader screen. Loader will become to show the latest inverter status.

Switching frequency and run command sources

Select the frequency and run command sources and apply them by clicking **Apply**.

* Refer to the table shown below for details of the operation buttons. The indented appearance of the **FWD** button as shown in the figure above indicates that it is active for running the motor forward, while that of the **REV** button is same for running reverse.

Button	Description
STOP	Stops the motor.
FWD	Run the motor forward.
REV	Run the motor reverse.
RESET	Resets all alarm information saved in the selected inverter.

5.2.3.5 Real-time trace—Displaying running status of an inverter in waveforms

This function allows you to monitor up to 4 analog readouts and up to 8 digital ON/OFF signals (a combined total of 8 channels), measured at fixed sampling intervals of 200 ms, which represent the running status of a selected inverter. These quantities are displayed in real-time waveforms on a time trace.

Waveform capturing capability: Max. 15,360 samples/channel

Sub-panes

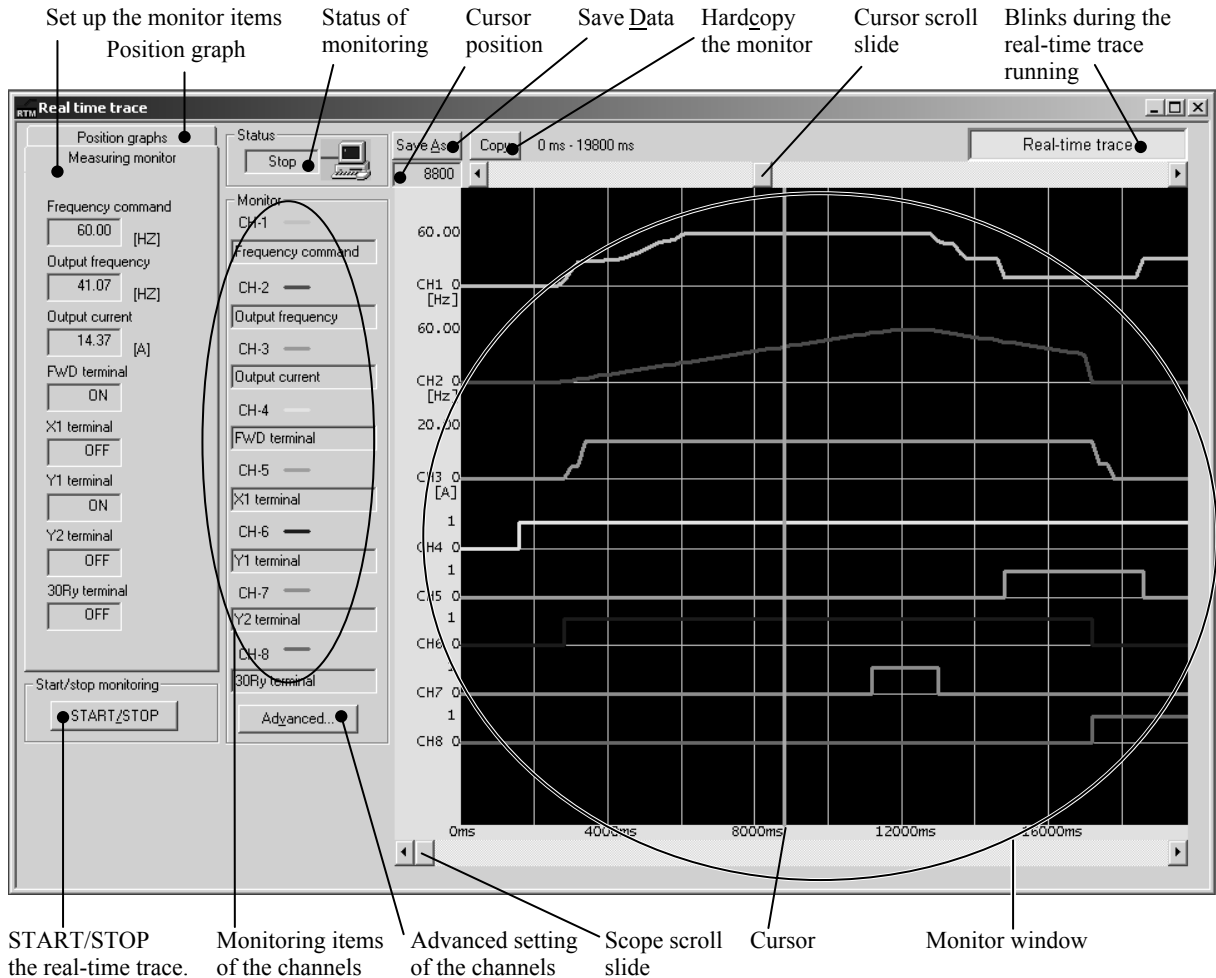

- Note** During the trace in progress you cannot:
- Change the RS-485 station address,
 - Change the advanced waveform settings, or
 - Scroll the real-time trace screen or move the cursor.

Resizing the real-time trace window automatically changes the monitor window size.

Part 3 Peripheral Equipment and Options



Chapter 6 SELECTING PERIPHERAL EQUIPMENT

CHAPTER 6

SELECTING PERIPHERAL EQUIPMENT

This chapter describes how to use a range of peripheral equipment and options, FRENIC-Eco's configuration with them, and requirements and precautions for selecting wires and crimp terminals.

Contents

6.1	Configuring the FRENIC-Eco	6-1
6.2	Selecting Wires and Crimp Terminals.....	6-2
6.2.1	Recommended wires	6-4
6.3	Peripheral Equipment.....	6-8
[1]	Molded case circuit breaker (MCCB), residual-current-operated protective device (RCD)/ earth leakage circuit breaker (ELCB) and magnetic contactor (MC)	6-8
[2]	Surge killers	6-12
[3]	Arresters.....	6-12
[4]	Surge absorbers.....	6-13
6.4	Selecting Options	6-14
6.4.1	Peripheral equipment options.....	6-14
[1]	DC reactors (DCRs)	6-14
[2]	AC reactors (ACRs)	6-16
[3]	Output circuit filters (OFLs).....	6-18
[4]	Ferrite ring reactors for reducing radio noise (ACL)	6-20
6.4.2	Options for operation and communications	6-21
[1]	External potentiometer for frequency setting.....	6-21
[2]	Multi-function keypad	6-22
[3]	Extension cable for remote operation.....	6-22
[4]	RS-485 communications card.....	6-23
[5]	Relay output card.....	6-24
[6]	DeviceNet interface card	6-25
[7]	PROFIBUS DP interface card	6-26
[8]	LonWorks interface card	6-27
[9]	Inverter support loader software.....	6-28
6.4.3	Extended installation kit options	6-29
[1]	Panel-mount Adapter	6-29
[2]	Mounting Adapter for External Cooling	6-30
6.4.4	Meter options.....	6-31
[1]	Frequency meters.....	6-31

6.1 Configuring the FRENIC-Eco

This section lists the names and features of peripheral equipment and options for the FRENIC-Eco series of inverters and includes a configuration example for reference. Refer to Figure 6.1 for a quick overview of available options.

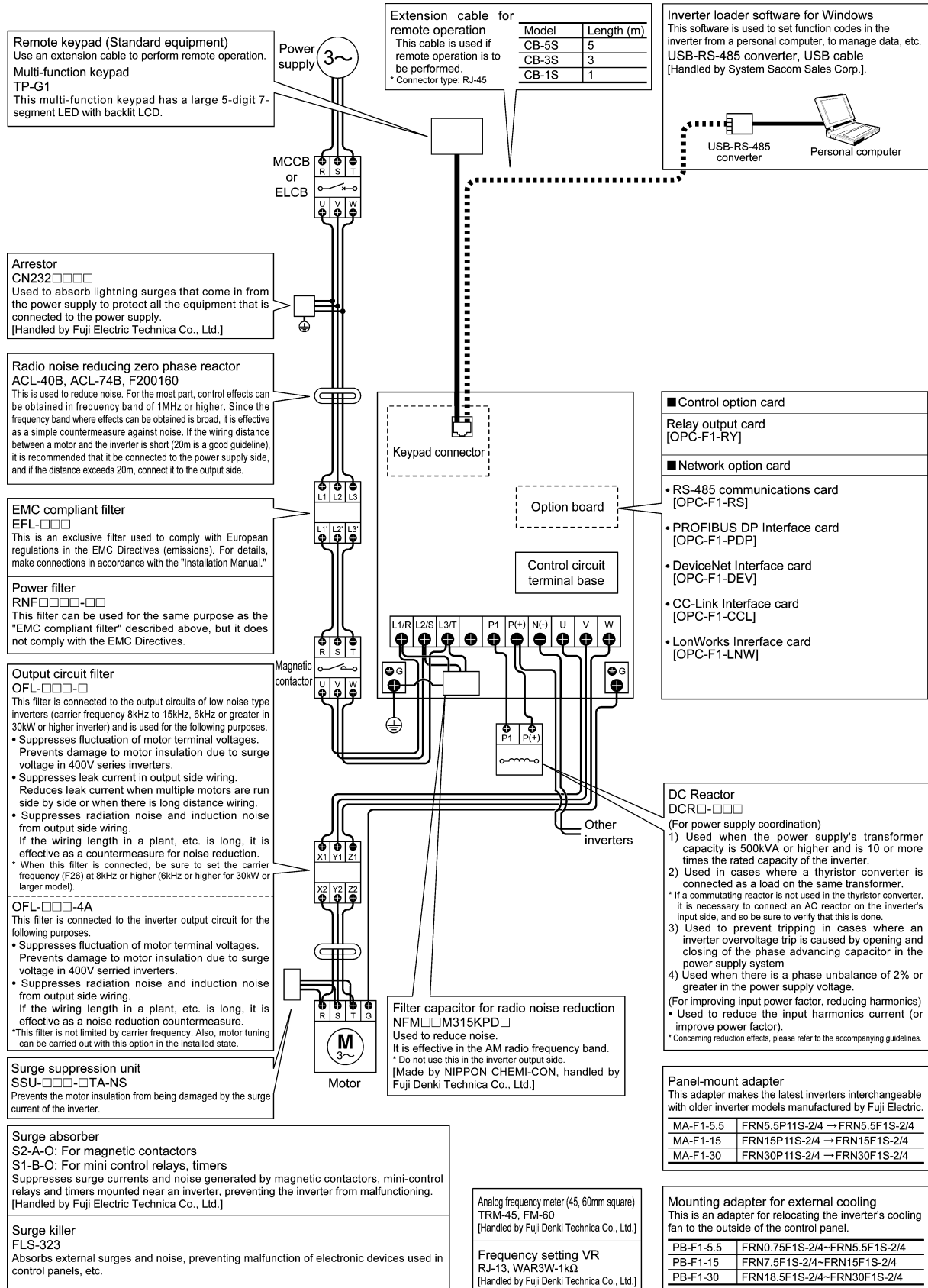

Figure 6.1 Quick Overview of Options

6.2 Selecting Wires and Crimp Terminals

This section contains information needed to select wires for connecting the inverter to commercial power lines, motor or any of the optional/peripheral equipment. The level of electric noise issued from the inverter or received by the inverter from external sources may vary depending upon wiring and routing. To solve such noise-related problems, refer to Appendices App. A "Advantageous Use of Inverters (Notes on electrical noise)."

Select wires that satisfy the following requirements:

- Sufficient capacity to flow the rated current (allowable current capacity).
- Protective device coordination with an overcurrent circuit breaker such as an MCCB in the overcurrent zone for overcurrent protection.
- Voltage drop due to the wire length is within the allowable range.
- Suitable for the type and size of terminals of the inverter and optional equipment to be used.

Recommended wires are listed below. Use these wires unless otherwise specified.

■ 600V indoor PVC insulated wires (IV wires)

Use this class of wire for the indoor power circuits. This class of wire is hard to twist, so using it for the control signal circuits is not recommended. Maximum ambient temperature for this wire is 60°C.

■ 600V heat-resistant PVC insulated wires or 600V polyethylene insulated wires (HIV wires)

As wires in this class are smaller in diameter and more flexible than IV wires and can be used at a higher ambient temperature (75°C), they can be used for both of the main power and control signal circuits. To use this class of wire for the control circuits, you need to correctly twist the wires and keep the wiring length for equipment being connected as short as possible.

■ 600V cross-link polyethylene-insulated wires (FSLC wires)

Use this class of wire mainly for power and grounding circuits. These wires are smaller in diameter and more flexible than those of the IV and HIV classes of wires, meaning that these wires can be used to save on space and on wiring cost of your power system, even in high temperature environments. The maximum allowable ambient temperature for this class of wires is 90°C. The (Boardlex) wire range available from Furukawa Electric Co., Ltd. satisfies these requirements.

■ Shielded-twisted cables for internal wiring of electronic/electric equipment

Use this category of cables for the control circuits of the inverter so as to prevent the signal lines from being affected by radiation or induction noises from external sources, including the power input/output lines of the inverter themselves. Even if the signal lines are inside the power control panel, always use this category of cables when the length of wiring is longer than normal. Cables satisfying these requirements are the Furukawa's BEAMEX S shielded cables of the XEBV and XEWW ranges.

Currents flowing through components of the inverter

Table 6.1 summarizes average (effective) electric currents flowing across each component of the inverter for ease of reference when selecting peripheral equipment, options and electric wires for each inverter--including supplied power voltage and applicable motor rating.

Table 6.1 Currents Flowing through Components of the Inverter

Power supply voltage	Applicable motor rating (kW)	Inverter type	50Hz, 200V/400V (380V)			60Hz, 220V (200V)/400V (440V)			
			Input RMS current (A)		DC link circuit current (A)	Input RMS current (A)		DC link bus current (A)	
			DC reactor (DCR)			DC reactor (DCR)			
			w/ DCR	w/o DCR	w/ DCR	w/o DCR			
Three-phase 200 V	0.75	FRN0.75F1■-2□	3.2	5.3	4.0	3.0 (3.2)	4.9 (5.3)	3.7 (4.0)	
	1.5	FRN1.5F1■-2□	6.1	9.5	7.5	5.6 (6.1)	8.7 (9.5)	6.9 (7.5)	
	2.2	FRN2.2F1■-2□	8.9	13.2	11.0	8.1 (8.9)	12.0 (13.1)	10.0 (11.0)	
	3.7	FRN3.7F1■-2□	15.0	22.2	18.4	13.6 (14.9)	20.0 (22.0)	16.7 (18.3)	
	5.5	FRN5.5F1■-2□	21.1	31.5	25.9	19.0 (20.9)	28.4 (31.2)	23.3 (25.6)	
	7.5	FRN7.5F1■-2□	28.8	42.7	35.3	26.0 (28.6)	38.5 (42.3)	31.9 (35.1)	
	11	FRN11F1■-2□	42.2	60.7	51.7	38.0 (41.8)	54.7 (60.1)	46.6 (51.2)	
	15	FRN15F1■-2□	57.6	80.1	70.6	52.0 (57.1)	72.2 (79.4)	63.7 (70.0)	
	18.5	FRN18.5F1■-2□	71.0	97.0	87.0	64.0 (70.3)	87.4 (96.1)	78.4 (86.1)	
	22	FRN22F1■-2□	84.4	112	103	76.0 (83.6)	101 (111)	93.1 (102)	
	30	FRN30F1■-2□	114	151	140	103 113	136 150	126 (138)	
	37	FRN37F1■-2□	138	185	169	124 137	167 183	152 (168)	
	45	FRN45F1■-2□	167	225	205	150 165	203 223	184 (203)	
	55	FRN55F1■-2□	203	270	249	183 201	243 267	224 (246)	
75	FRN75F1■-2□	282	-	345	254 279	-	311 (342)		
90	FRN90F1■-2□	334	-	409	301 331	-	368 (405)		
110	FRN110F1■-2□	410	-	502	369 406	-	452 (497)		
Three-phase 400 V	0.75	FRN0.75F1S-4E	1.6 (1.7)	3.1 (3.3)	2.0 (2.1)	1.6 (1.5)	3.1 (2.9)	2.0 (1.9)	
	1.5	FRN1.5F1S-4E	3.0 (3.2)	5.9 (6.3)	3.7 (4.0)	3.0 (2.8)	5.9 (5.4)	3.7 (3.5)	
	2.2	FRN2.2F1S-4E	4.5 (4.8)	8.2 (8.7)	5.6 (5.9)	4.5 (4.1)	8.2 (7.5)	5.6 (5.1)	
	4.0	FRN4.0F1S-4E	7.5 (7.9)	13 (13.7)	9.2 (9.7)	7.5 (6.9)	12.9 (11.8)	9.2 (8.5)	
	5.5	FRN5.5F1S-4E	10.6 (11.2)	17.3 (18.3)	13.0 (13.8)	10.5 (9.6)	17.2 (15.7)	12.9 (11.8)	
	7.5	FRN7.5F1S-4E	14.4 (15.2)	23.2 (24.5)	17.7 (18.7)	14.3 (13.0)	23.0 (21.0)	17.6 (16.0)	
	11	FRN11F1S-4E	21.1 (22.3)	33.0 (34.8)	25.9 (27.4)	20.9 (19.0)	32.7 (29.8)	25.6 (23.3)	
	15	FRN15F1S-4E	28.8 (30.4)	43.8 (46.2)	35.3 (37.3)	28.6 (26.0)	43.4 (39.5)	35.1 (31.9)	
	18.5	FRN18.5F1S-4E	35.5 (37.4)	52.3 (55.1)	43.5 (45.9)	35.2 (32.0)	51.8 (47.1)	43.2 (39.2)	
	22	FRN22F1S-4E	42.2 (44.5)	60.6 (63.8)	51.7 (54.6)	41.8 (38.0)	60.0 (54.6)	51.2 (46.6)	
	30	FRN30F1S-4E	57.0 (60.0)	77.9 (82.0)	69.9 (73.5)	56.5 (51.4)	77.2 (70.2)	69.2 (63.0)	
	37	FRN37F1S-4E	68.5 (72.2)	94.3 (99.3)	83.9 (88.5)	67.9 (61.8)	93.4 (85.0)	83.2 (75.7)	
	45	FRN45F1S-4E	83.2 (87.6)	114 (120)	102 (107)	82.4 (75.0)	113 (103)	101.0 (92)	
	55	FRN55F1S-4E	102 (107)	140 (147)	125 (132)	101.0 (92)	139 (126)	124 (113)	
	75	FRN75F1S-4E	138 (145)	-	169 (178)	137 (124)	-	168 (152)	
	90	FRN90F1S-4E	164 (173)	-	201 (212)	162 (148)	-	199 (181)	
	110	FRN110F1S-4E	201 (212)	-	246 (259)	199 (181)	-	244 (222)	
	132	FRN132F1S-4E	238 (251)	-	292 (307)	236 (214)	-	289 (263)	
	160	FRN160F1S-4E	286 (301)	-	350 (369)	283 (258)	-	347 (315)	
	200	FRN200F1S-4E	357 (376)	-	437 (460)	354 (321)	-	433 (394)	
220	FRN220F1S-4E	390 (411)	-	478 (503)	386 (351)	-	473 (430)		
280	FRN280F1S-4E	500 (526)	-	612 (645)	495 (450)	-	606 (551)		
315	FRN315F1S-4E	559 (589)	-	685 (721)	554 (503)	-	678 (616)		
355	FRN355F1S-4E	628 (661)	-	769 (810)	622 (565)	-	762 (692)		
400	FRN400F1S-4E	705 (742)	-	864 (909)	698 (635)	-	855 (777)		
450	FRN450F1S-4E	789 (831)	-	966 (1017)	781 (710)	-	957 (870)		
500	FRN500F1S-4E	881 (927)	-	1079 (1136)	872 (793)	-	1068 (971)		
560	FRN560F1S-4E	990 (1042)	-	1213 (1277)	980 (891)	-	1201 (1091)		

- Inverter efficiency is calculated using values suitable for each inverter model. The input route mean square (RMS) current is calculated under the following conditions:

Power supply capacity: 500 kVA; power supply impedance: 5%

- The RMS current listed in the above table will vary in inverse proportion to the power supply voltage, such as 230 VAC and 380 VAC.

- Note 1) A box (■) in the above table replaces S (Standard type), E (EMC filter built-in type), H (DCR built-in type), or B or D/L (Waterproof type) depending on the product specifications.
 2) A box (□) in the above table replaces A, C, E, or J depending on the shipping destination.

6.2.1 Recommended wires

Tables 6.2 and 6.3 list the recommended wires according to the internal temperature of the panel, for ease of reference to wiring of each inverter model.

■ If the internal temperature of the panel is 50°C or below

Table 6.2 Wire Size (for main circuit power input and inverter output)

Power supply voltage	Applicable motor rating (kW)	Inverter type	Recommended wire size (mm ²)											
			Main circuit power input [L1/R, L2/S, L3/T]								Inverter output [U, V, W]			
			w/ DC reactor (DCR)				w/o DC reactor (DCR)				w/o DC reactor (DCR)			
			Allowable temp. *1			Current (A)	Allowable temp. *1			Current (A)	Allowable temp. *1			Current (A)
60°C	75°C	90°C	60°C	75°C	90°C		60°C	75°C	90°C					
Three-phase 200 V	0.75	FRN0.75F1■-2□	2.0	2.0	2.0	3.2	2.0	2.0	2.0	5.3	2.0	2.0	2.0	4.2
	1.5	FRN1.5F1■-2□	2.0	2.0	2.0	6.1	2.0	2.0	2.0	9.5	2.0	2.0	2.0	7.0
	2.2	FRN2.2F1■-2□	2.0	2.0	2.0	8.9	2.0	2.0	2.0	13.2	2.0	2.0	2.0	10.6
	3.7	FRN3.7F1■-2□	2.0	2.0	2.0	15.0	5.5	2.0	2.0	22.2	3.5	2.0	2.0	16.7
	5.5	FRN5.5F1■-2□	5.5	2.0	2.0	21.1	8.0	3.5	3.5	31.5	5.5	2.0	2	22.5
	7.5	FRN7.5F1■-2□	8.0	3.5	2.0	28.8	14.0	5.5	5.5	42.7	8.0	3.5	2	29.0
	11	FRN11F1■-2□	14.0	5.5	5.5	42.2	22.0	14.0	8.0	60.7	14.0	5.5	3.5	42.0
	15	FRN15F1■-2□	22.0	14.0	8.0	57.6	38.0	22.0	14.0	80.1	22.0	8.0	5.5	55.0
	18.5	FRN18.5F1■-2□	38.0	14.0	14.0	71.0	60.0	22.0	14.0	97.0	38.0	14.0	8.0	68.0
	22	FRN22F1■-2□	38.0	22.0	14.0	84.4	60.0	38.0	22.0	112	38.0	14.0	14.0	80.0
	30	FRN30F1■-2□	60.0	38.0	22.0	114	100	60.0	38.0	151	60.0	38.0	22.0	107
	37	FRN37F1■-2□	100 *2	38.0	38.0	138	60*2	60.0	38.0	185	100 *2	38.0	22.0	130
	45	FRN45F1■-2□	100	60.0	38.0	167	100*2	100	60.0	225	100	60.0	38.0	156
	55	FRN55F1■-2□	60*2	100	60.0	203	100*2	100	100	270	60*2	100	60.0	198
75	FRN75F1■-2□	100*2	150 *3	100	282	-	-	-	-	100*2	100	100	270	
90	FRN90F1■-2□	-	150	100	334	-	-	-	-	-	150	100	320	
110	FRN110F1■-2□	-	200	150	410	-	-	-	-	-	200	150	384	
Three-phase 400 V	0.75	FRN0.75F1S-4E	2.0	2.0	2.0	1.6	2.0	2.0	2.0	3.1	2.0	2.0	2.0	2.5
	1.5	FRN1.5F1S-4E	2.0	2.0	2.0	3.0	2.0	2.0	2.0	5.9	2.0	2.0	2.0	3.7
	2.2	FRN2.2F1S-4E	2.0	2.0	2.0	4.5	2.0	2.0	2.0	8.2	2.0	2.0	2.0	5.5
	4.0	FRN4.0F1S-4E	2.0	2.0	2.0	7.5	2.0	2.0	2.0	13.0	2.0	2.0	2.0	9.0
	5.5	FRN5.5F1S-4E	2.0	2.0	2.0	10.6	3.5	2.0	2.0	17.3	2.0	2.0	2.0	12.5
	7.5	FRN7.5F1S-4E	2.0	2.0	2.0	14.4	5.5	2.0	2.0	23.2	3.5	2.0	2.0	16.5
	11	FRN11F1S-4E	5.5	2.0	2.0	21.1	8.0	3.5	3.5	33.0	5.5	2.0	2.0	23.0
	15	FRN15F1S-4E	8.0	3.5	2.0	28.8	14.0	5.5	5.5	43.8	8.0	3.5	2.0	30.0
	18.5	FRN18.5F1S-4E	14.0	5.5	3.5	35.5	22.0	8.0	5.5	52.3	14.0	5.5	3.5	37.0
	22	FRN22F1S-4E	14.0	5.5	5.5	42.2	22.0	14.0	8.0	60.6	14.0	5.5	5.5	44.0
	30	FRN30F1S-4E	22.0	14.0	8.0	57.0	38.0	14.0	14.0	77.9	22.0	14.0	8.0	58.0
	37	FRN37F1S-4E	38.0	14.0	8.0	68.5	60.0	22.0	14.0	94.3	38.0	14.0	14.0	71.0
	45	FRN45F1S-4E	38.0	22.0	14.0	83.2	60.0	38.0	22.0	114	38.0	22.0	14.0	84.0
	55	FRN55F1S-4E	60.0	22.0	22.0	102	100 *2	38.0	38.0	140	60.0	22.0	22.0	102
	75	FRN75F1S-4E	100 *2	38.0	38.0	138	-	-	-	-	100 *2	38.0	38.0	139
	90	FRN90F1S-4E	100	60.0	38.0	164	-	-	-	-	100	60.0	38.0	168
	110	FRN110F1S-4E	60*2	100	60.0	201	-	-	-	-	60*2	100	60.0	203
	132	FRN132F1S-4E	100*2	100	60.0	238	-	-	-	-	100*2	100	60.0	240
	160	FRN160F1S-4E	-	150	100	286	-	-	-	-	100*2	150	100	290
	200	FRN200F1S-4E	-	150	150	357	-	-	-	-	-	200	150	360
220	FRN220F1S-4E	-	200	150	390	-	-	-	-	-	200	150	415	
280	FRN280F1S-4E	-	250	200	500	-	-	-	-	-	325	200	520	
315	FRN315F1S-4E	-	325	250	559	-	-	-	-	-	325	250	585	
355	FRN355F1S-4E	-	200*2	250	628	-	-	-	-	-	200*2	325	650	
400	FRN400F1S-4E	-	200*2	325	705	-	-	-	-	-	250*2	325	740	
450	FRN450F1S-4E	-	250*2	200*2	789	-	-	-	-	-	250*2	200*2	840	
500	FRN500F1S-4E	-	325*2	200*2	881	-	-	-	-	-	325*2	250*2	960	
560	FRN560F1S-4E	-	250*3	250*2	990	-	-	-	-	-	250*3	250*2	1040	

*1 Assuming the use of aerial wiring (without rack or duct): 600V indoor PVC insulated wires (IV wires) for up to 60°C, 600V heat-resisting PVC insulated wires or 600V class polyethylene insulated wires (HIV wires) for up to 75°C, and 600V cross-link polyethylene-insulated wires (FSLC wires) for up to 90°C.

*2 Use crimp terminals for low voltage devices, CB100-8 (JEM 1399) compliant.

*3 Use crimp terminals for low voltage devices, CB150-10 (JEM 1399) compliant.

Note 1) A box (■) in the above table replaces S (Standard type), E (EMC filter built-in type), H (DCR built-in type), or B or D/L (Waterproof type) depending on the product specifications.

2) A box (□) in the above table replaces A, C, E, or J depending on the shipping destination.



If environmental requirements such as power supply voltage and ambient temperature differ from those recommendations listed above, select wires suitable for your system by referring to Table 6.1 and Appendices, App. F "Allowable Current of Insulated Wires."

Table 6.2 Cont. (for DC reactor, control circuits, auxiliary power input (for the control circuit and fans) and inverter grounding)

Power supply voltage	Applicable motor rating (kW)	Inverter type	Recommended wire size (mm ²)														
			DC reactor [P1, P(+)]				Control circuit			Aux. power input (Ctrl. Cct.) [R0,T0]			Aux. power input (Fans) [R1,T1]			Inverter grounding [EG]	
			Allowable temp. *1			Current (A)	Allowable temp. *1			Allowable temp. *1			Allowable temp. *1			Allowable temp. *1	
			60°C	75°C	90°C		60°C	75°C	90°C	60°C	75°C	90°C	60°C	75°C	90°C	60°C	75°C
Three-phase 200 V	0.75	FRN0.75F1■-2□	2.0	2.0	2.0	4.0	0.75 to 1.25	0.75 to 1.25	0.75 to 1.25	2.0	2.0	2.0	-	-	-	2.0	
	1.5	FRN1.5F1■-2□	2.0	2.0	2.0	7.5											2.0
	2.2	FRN2.2F1■-2□	2.0	2.0	2.0	11.0											
	3.7	FRN3.7F1■-2□	3.5	2.0	2.0	18.4											
	5.5	FRN5.5F1■-2□	5.5	3.5	2.0	25.9											
	7.5	FRN7.5F1■-2□	14.0	5.5	3.5	35.3											
	11	FRN11F1■-2□	22.0	8.0	5.5	51.7											
	15	FRN15F1■-2□	38.0	14.0	14.0	70.6											
	18.5	FRN18.5F1■-2□	38.0	22.0	14.0	87.0											
	22	FRN22F1■-2□	60.0	22.0	22.0	104											
	30	FRN30F1■-2□	100	38.0	38.0	140											
	37	FRN37F1■-2□	100 *2	60.0	38.0	170											
	45	FRN45F1■-2□	-	100	60.0	205											
	55	FRN55F1■-2□	-	100	60.0	249											
75	FRN75F1■-2□	-	150	150	346												
90	FRN90F1■-2□	-	250	150	409												
110	FRN110F1■-2□	-	325	200	502												
Three-phase 400 V	0.75	FRN0.75F1S-4E	2.0	2.0	2.0	2.1	0.75 to 1.25	0.75 to 1.25	0.75 to 1.25	2.0	2.0	2.0	-	-	-	2.0	
	1.5	FRN1.5F1S-4E	2.0	2.0	2.0	4.0											
	2.2	FRN2.2F1S-4E	2.0	2.0	2.0	5.9											
	4.0	FRN4.0F1S-4E	2.0	2.0	2.0	9.7											
	5.5	FRN5.5F1S-4E	2.0	2.0	2.0	13.8											
	7.5	FRN7.5F1S-4E	3.5	2.0	2.0	18.7											
	11	FRN11F1S-4E	5.5	3.5	2.0	27.4											
	15	FRN15F1S-4E	14.0	5.5	3.5	37.3											
	18.5	FRN18.5F1S-4E	14.0	8.0	5.5	45.9											
	22	FRN22F1S-4E	22.0	8.0	5.5	54.6											
	30	FRN30F1S-4E	38.0	14.0	14.0	73.5											
	37	FRN37F1S-4E	38.0	22.0	14.0	88.5											
	45	FRN45F1S-4E	60.0	38.0	22.0	108											
	55	FRN55F1S-4E	100 *2	38.0	22.0	132											
	75	FRN75F1S-4E	60*2	60.0	38.0	178											
	90	FRN90F1S-4E	-	100	60.0	212											
	110	FRN110F1S-4E	-	100	100	260											
	132	FRN132F1S-4E	-	150	100	307											
	160	FRN160F1S-4E	-	200	150	369											
	200	FRN200F1S-4E	-	250	200	461											
	220	FRN220F1S-4E	-	250	200	503											
	280	FRN280F1S-4E	-	200*2	325	645											
	315	FRN315F1S-4E	-	250*2	150*2	721											
	355	FRN355F1S-4E	-	250*2	200*2	810											
400	FRN400F1S-4E	-	325*2	250*2	909												
450	FRN450F1S-4E	-	250*3	250*2	1017												
500	FRN500F1S-4E	-	325*3	325*2	1136												
560	FRN560F1S-4E	-	325*3	250*3	1277												

*1 Assuming the use of aerial wiring (without rack or duct): 600V indoor PVC insulated wires (IV wires) for up to 60°C, 600V heat-resisting PVC insulated wires or 600V class polyethylene insulated wires (HIV wires) for up to 75°C, and 600V cross-link polyethylene-insulated wires (FSLC wires) for up to 90°C.

*2 Use crimp terminals for low voltage devices, CB100-8 (JEM 1399) compliant.

Note 1) A box (■) in the above table replaces S (Standard type), E (EMC filter built-in type), H (DCR built-in type), or B or D/L (Waterproof type) depending on the product specifications.
 2) A box (□) in the above table replaces A, C, E, or J depending on the shipping destination.

 If environmental requirements such as power supply voltage and ambient temperature differ from those recommendations listed above, select wires suitable for your system by referring to Table 6.1 and Appendices, App. F "Allowable Current of Insulated Wires."

■ If the internal temperature of the panel is 40°C or below

Table 6.3 Wire Size (for main circuit power input and inverter output)

Power supply voltage	Applicable motor rating (kW)	Inverter type	Recommended wire size (mm ²)											
			Main circuit power input [L1/R, L2/S, L3/T]							Inverter output [U, V, W]				
			w/ DC reactor (DCR)			w/o DC reactor (DCR)				Inverter output [U, V, W]				
			Allowable temp. *1			Current (A)	Allowable temp. *1			Current (A)	Allowable temp. *1			Current (A)
60°C	75°C	90°C	60°C	75°C	90°C		60°C	75°C	90°C					
Three-phase 200 V	0.75	FRN0.75F1■-2□	2.0	2.0	2.0	3.2	2.0	2.0	2.0	5.3	2.0	2.0	2.0	4.2
	1.5	FRN1.5F1■-2□	2.0	2.0	2.0	6.1	2.0	2.0	2.0	9.5	2.0	2.0	2.0	7.0
	2.2	FRN2.2F1■-2□	2.0	2.0	2.0	8.9	2.0	2.0	2.0	13.2	2.0	2.0	2.0	10.6
	3.7	FRN3.7F1■-2□	2.0	2.0	2.0	15.0	3.5	2.0	2.0	22.2	2.0	2.0	2.0	16.7
	5.5	FRN5.5F1■-2□	2.0	2.0	2.0	21.1	5.5	3.5	2.0	31.5	3.5	2.0	2.0	22.5
	7.5	FRN7.5F1■-2□	3.5	2.0	2.0	28.8	8.0	5.5	3.5	42.7	3.5	2.0	2.0	29.0
	11	FRN11F1■-2□	8.0	5.5	3.5	42.2	14.0	8.0	5.5	60.7	8.0	5.5	3.5	42.0
	15	FRN15F1■-2□	14.0	8.0	5.5	57.6	22.0	14.0	14.0	80.1	14.0	8.0	5.5	55.0
	18.5	FRN18.5F1■-2□	14.0	14.0	8.0	71.0	38.0	22.0	14.0	97.0	14.0	14.0	8.0	68.0
	22	FRN22F1■-2□	22.0	14.0	14.0	84.4	38.0	22.0	14.0	112	22.0	14.0	14.0	80.0
	30	FRN30F1■-2□	38.0	22.0	22.0	114	60.0	38.0	38.0	151	38.0	22.0	14.0	107
	37	FRN37F1■-2□	60.0	38.0	22.0	138	100 *2	60.0	38.0	185	38.0	38.0	22.0	130
	45	FRN45F1■-2□	60.0	38.0	38.0	167	100	60.0	60.0	225	60.0	38.0	38.0	156
	55	FRN55F1■-2□	100	60.0	38.0	203	60×2	100	60.0	270	100	60.0	38.0	198
	75	FRN75F1■-2□	60×2	100	100	282	-	-	-	-	60×2	100	60.0	270
90	FRN75F1■-2□	-	150	100	334	-	-	-	-	-	100	100	320	
110	FRN75F1■-2□	-	150	150	410	-	-	-	-	-	150	100	384	
Three-phase 400 V	0.75	FRN0.75F1S-4E	2.0	2.0	2.0	1.6	2.0	2.0	2.0	3.1	2.0	2.0	2.0	2.5
	1.5	FRN1.5F1S-4E	2.0	2.0	2.0	3.0	2.0	2.0	2.0	5.9	2.0	2.0	2.0	3.7
	2.2	FRN2.2F1S-4E	2.0	2.0	2.0	4.5	2.0	2.0	2.0	8.2	2.0	2.0	2.0	5.5
	4.0	FRN4.0F1S-4E	2.0	2.0	2.0	7.5	2.0	2.0	2.0	13.0	2.0	2.0	2.0	9.0
	5.5	FRN5.5F1S-4E	2.0	2.0	2.0	10.6	2.0	2.0	2.0	17.3	2.0	2.0	2.0	12.5
	7.5	FRN7.5F1S-4E	2.0	2.0	2.0	14.4	3.5	2.0	2.0	23.2	2.0	2.0	2.0	16.5
	11	FRN11F1S-4E	2.0	2.0	2.0	21.1	5.5	3.5	2.0	33.0	3.5	2.0	2.0	23.0
	15	FRN15F1S-4E	3.5	2.0	2.0	28.8	8.0	5.5	3.5	43.8	3.5	3.5	2.0	30.0
	18.5	FRN18.5F1S-4E	5.5	3.5	3.5	35.5	14.0	8.0	5.5	52.3	5.5	3.5	3.5	37.0
	22	FRN22F1S-4E	8.0	5.5	3.5	42.2	14.0	8.0	5.5	60.6	8.0	5.5	3.5	44.0
	30	FRN30F1S-4E	14.0	8.0	5.5	57.0	22.0	14.0	8.0	77.9	14.0	8.0	5.5	58.0
	37	FRN37F1S-4E	14.0	14.0	8.0	68.5	22.0	14.0	14.0	94.3	14.0	14.0	8.0	71.0
	45	FRN45F1S-4E	22.0	14.0	14.0	83.2	38.0	22.0	14.0	114	22.0	14.0	14.0	84.0
	55	FRN55F1S-4E	38.0	22.0	14.0	102	60.0	38.0	22.0	140	38.0	22.0	14.0	102
	75	FRN75F1S-4E	60.0	38.0	22.0	138	-	-	-	-	60.0	38.0	22.0	139
	90	FRN90F1S-4E	60	38.0	38	164	-	-	-	-	60	38.0	38.0	168
	110	FRN110F1S-4E	100	60.0	38.0	201	-	-	-	-	100	60	38.0	203
	132	FRN132F1S-4E	100	100	60.0	238	-	-	-	-	100	100	60.0	240
	160	FRN160F1S-4E	60×2	100	100	286	-	-	-	-	60×2	100	100	290
	200	FRN200F1S-4E	100×2	150	100	357	-	-	-	-	100×2	150	100	360
220	FRN220F1S-4E	100×2	150	150	390	-	-	-	-	100×2	150	150	415	
280	FRN280F1S-4E	-	200	150	500	-	-	-	-	-	250	200	520	
315	FRN315F1S-4E	-	250	200	559	-	-	-	-	-	250	200	585	
355	FRN355F1S-4E	-	325	250	628	-	-	-	-	-	325	250	650	
400	FRN400F1S-4E	-	150×2	250	705	-	-	-	-	-	325	325	740	
450	FRN450F1S-4E	-	200×2	325	789	-	-	-	-	-	200×2	150×2	840	
500	FRN500F1S-4E	-	250×2	200×2	881	-	-	-	-	-	250×2	200×2	960	
560	FRN560F1S-4E	-	250×2	200×2	990	-	-	-	-	-	250×2	250×2	1040	

*1 Assuming the use of aerial wiring (without rack or duct): 600V indoor PVC insulated wires (IV wires) for up to 60°C, 600V heat-resisting PVC insulated wires or 600V class polyethylene insulated wires (HIV wires) for up to 75°C, and 600V cross-link polyethylene-insulated wires (FSLC wires) for up to 90°C.

*2 Use crimp terminals for low voltage devices, CB100-8 (JEM 1399) compliant.

Note 1) A box (■) in the above table replaces S (Standard type), E (EMC filter built-in type), H (DCR built-in type), or B or D/L (Waterproof type) depending on the product specifications.

2) A box (□) in the above table replaces A, C, E, or J depending on the shipping destination.



If environmental requirements such as power supply voltage and ambient temperature differ from those recommendations listed above, select wires suitable for your system by referring to Table 6.1 and Appendices, App. F "Allowable Current of Insulated Wires."

Table 6.3 Cont. (for DC reactor, control circuits, auxiliary power input (for the control circuit and fans) and inverter grounding)

Power supply voltage	Applicable motor rating (kW)	Inverter type	Recommended wire size (mm ²)														
			DC reactor [P1, P(+)]				Control circuit			Aux. power input (Ctrl. Cct.) [R0, T0]			Aux. power input (Fans) [R1, T1]			Inverter grounding [G]	
			Allowable temp. *1			Current (A)	Allowable temp. *1			Allowable temp. *1			Allowable temp. *1			Allowable temp. *1	
			60°C	75°C	90°C		60°C	75°C	90°C	60°C	75°C	90°C	60°C	75°C	90°C	60°C	75°C
Three-phase 200 V	0.75	FRN0.75F1■-2□	2.0	2.0	2.0	4.0	0.75 to 1.25	0.75 to 1.25	0.75 to 1.25	2.0	2.0	2.0	-	-	-	2.0	
	1.5	FRN1.5F1■-2□	2.0	2.0	2.0	7.5											2.0
	2.2	FRN2.2F1■-2□	2.0	2.0	2.0	11.0											2.0
	3.7	FRN3.7F1■-2□	2.0	2.0	2.0	18.4											2.0
	5.5	FRN5.5F1■-2□	3.5	2.0	2.0	25.9											2.0
	7.5	FRN7.5F1■-2□	5.5	3.5	3.5	35.3											2.0
	11	FRN11F1■-2□	14.0	5.5	5.5	51.7											2.0
	15	FRN15F1■-2□	14.0	14.0	8.0	70.6											2.0
	18.5	FRN18.5F1■-2□	22.0	14.0	14.0	87.0											2.0
	22	FRN22F1■-2□	38.0	22.0	14.0	103											2.0
	30	FRN30F1■-2□	60.0	38.0	22.0	140											2.0
	37	FRN37F1■-2□	60.0	38.0	38.0	169											2.0
	45	FRN45F1■-2□	100	60	38.0	205											2.0
	55	FRN55F1■-2□	-	100	60	249											2.0
75	FRN75F1■-2□	-	150	100	345	2.0											
90	FRN75F1■-2□	-	150	150	409	2.0											
110	FRN75F1■-2□	-	200	150	502	2.0											
Three-phase 400 V	0.75	FRN0.75F1S-4E	2.0	2.0	2.0	2.1	0.75 to 1.25	0.75 to 1.25	0.75 to 1.25	2.0	2.0	2.0	-	-	-	2.0	
	1.5	FRN1.5F1S-4E	2.0	2.0	2.0	4.0											2.0
	2.2	FRN2.2F1S-4E	2.0	2.0	2.0	5.9											2.0
	4.0	FRN4.0F1S-4E	2.0	2.0	2.0	9.7											2.0
	5.5	FRN5.5F1S-4E	2.0	2.0	2.0	13.8											2.0
	7.5	FRN7.5F1S-4E	2.0	2.0	2.0	18.7											2.0
	11	FRN11F1S-4E	3.5	2.0	2.0	27.4											2.0
	15	FRN15F1S-4E	5.5	3.5	3.5	37.3											2.0
	18.5	FRN18.5F1S-4E	8.0	5.5	3.5	45.9											2.0
	22	FRN22F1S-4E	14.0	8.0	5.5	54.6											2.0
	30	FRN30F1S-4E	22.0	14.0	8.0	73.5											2.0
	37	FRN37F1S-4E	22.0	14.0	14.0	88.5											2.0
	45	FRN45F1S-4E	38.0	22.0	14.0	107											2.0
	55	FRN55F1S-4E	38.0	38.0	22.0	132											2.0
	75	FRN75F1S-4E	60	60.0	38.0	178											2.0
	90	FRN90F1S-4E	100	60.0	60.0	212											2.0
	110	FRN110F1S-4E	-	100	60.0	259											2.0
	132	FRN132F1S-4E	-	100	100	307											2.0
	160	FRN160F1S-4E	100×2	150	100	369											2.0
	200	FRN200F1S-4E	-	200	150	460											2.0
	220	FRN220F1S-4E	-	200	150	503											2.0
	280	FRN280F1S-4E	-	325	250	644											2.0
315	FRN315F1S-4E	-	200×2	325	720	2.0											
355	FRN355F1S-4E	-	200×2	325	810	2.0											
400	FRN400F1S-4E	-	250×2	200×2	909	2.0											
450	FRN450F1S-4E	-	325×2	250×2	1017	2.0											
500	FRN500F1S-4E	-	325×2	250×2	1135	2.0											
560	FRN560F1S-4E	-	325×3	325×2	1276	2.0											

*1 Assuming the use of aerial wiring (without rack or duct): 600V indoor PVC insulated wires (IV wires) for up to 60°C, 600V heat-resisting PVC insulated wires or 600V class polyethylene insulated wires (HIV wires) for up to 75°C, and 600V cross-link polyethylene-insulated wires (FSLC wires) for up to 90°C.

- Note 1) A box (■) in the above table replaces S (Standard type), E (EMC filter built-in type), H (DCR built-in type), or B or D/L (Waterproof type) depending on the product specifications.
 2) A box (□) in the above table replace 0s A, C, E, or J depending on the shipping destination.

 If environmental requirements such as power supply voltage and ambient temperature differ from those recommendations listed above, select wires suitable for your system by referring to Table 6.1 and Appendices, App. F "Allowable Current of Insulated Wires."

6.3 Peripheral Equipment

[1] Molded case circuit breaker (MCCB), residual-current-operated protective device (RCD)/earth leakage circuit breaker (ELCB) and magnetic contactor (MC)

[1.1] Functional overview

■ MCCBs and RCDs/ELCBs*

*With overcurrent protection

Molded Case Circuit Breakers (MCCBs) are designed to protect the power circuits between the power supply and inverter's main circuit terminals (L1/R, L2/S and L3/T) from overload or short-circuit, which in turn prevents secondary accidents caused by the inverter malfunctioning.

Residual-Current-Operated Protective Devices (RCDs)/Earth Leakage Circuit Breakers (ELCBs) function in the same way as MCCBs.

Built-in overcurrent/overload protective functions protect the inverter itself from failures related to its input/output lines.

■ MCs

An MC can be used at both the power input (primary) and output (secondary) sides of the inverter. At each side, the Magnetic Contactor (MC) works as described below. When inserted in the output circuit of inverter, the MC can also switch the motor drive power source between the inverter output and commercial power lines.

At the power source (primary) side

Insert an MC in the power source side of the inverter in order to:

- (1) Forcibly cut off the inverter from the power source with the protective function built into the inverter, or with the external signal input.
- (2) Stop the inverter operation in an emergency when the inverter cannot interpret the stop command due to internal/external circuit failures.
- (3) Cut off the inverter from the power supply if the MCCB on the power supply side cannot be turned OFF when maintenance or inspection of motor is required. For this purpose only, it is recommended that you use an MC that can be turned off manually.

 **Note** When your system uses an MC to start or stop the inverter, keep the number of start/stop operations once or less per hour. Frequent such operations shorten not only the service life of the MC but also that of the inverter DC link bus capacitor(s) due to the thermal fatigue caused by the frequent flow of the charging current. Use terminal commands (FWD) and (REV) or the keypad as much as possible, to start or stop the inverter.

At the output (secondary) side

Insert an MC in the power output side of the inverter in order to:

- (1) Prevent externally turned-around current from being applied to the inverter power output terminals (U, V, and W) unexpectedly. An MC should be used, for example, if a circuit that switches the motor driving power source between the inverter output and commercial power lines is connected to the inverter.

 **Tip** As application of the external power to the inverter's output side may break the Insulated Gate Bipolar Transistors (IGBTs), MCs should be used in the power control system circuits to switch the motor drive power source to the commercial power lines after the motor has come to a complete stop. Also ensure that voltage is never mistakenly applied to the inverter output terminals due to unexpected timer operation, or similar.

- (2) Drive more than one motor selectively by a single inverter.
- (3) Selectively cut off the motor whose thermal overload relay or equivalent devices have been activated.

Driving the motor using commercial power lines

MCs can also be used to run the motor driven by the inverter by a commercial power source.

Select the MC so as to satisfy the input RMS currents listed in Table 6.1, which are the most critical for using the inverter (Refer to Table 6.5).

Use an MC of class AC3 specified by IEC 60947-4-1 (JIS C8201-4-1) for the commercial power operation when you are making a switching operation of the motor between the inverter output and commercial power lines.

[1.2] Applications and criteria for selection of contactors

Figure 6.2 shows external views and applications of MCCB or RCD/ELCB (with overcurrent protection) and MC in the inverter input circuit. Table 6.5 lists the rated current for the MCCB or RCD/ELCB and Fuji MC type. Table 6.6 lists the leakage current sensibility of the RCD/ELCB in conjunction with wiring length.

 WARNING
<p>Insert an MCCB or RCD/ELCB (with overcurrent protection) recommended for each inverter for its input circuits. Do not use an MCCB or RCD/ELCB of a higher rating than that recommended.</p> <p>Doing so could result in a fire.</p>

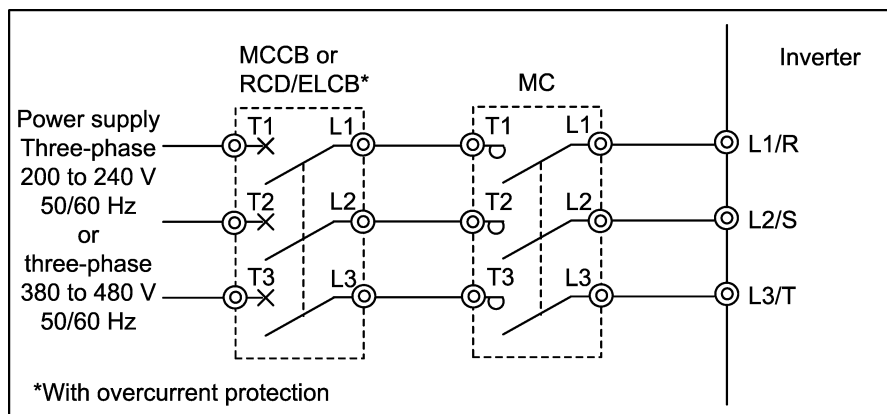
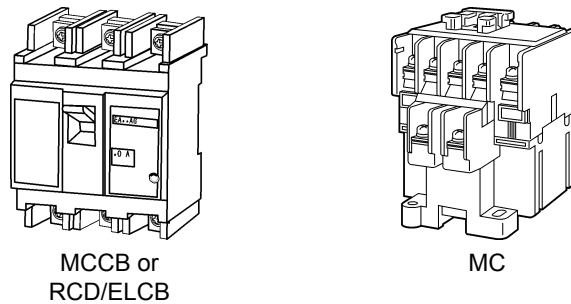

Figure 6.2 External Views and Applications of MCCB or RCD/ELCB and MC

Table 6.5 Rated Current of MCCB , RCD/ELCB and MC (Note that values in the table below are valid in 50°C of ambient temperature.)

Power supply voltage	Applicable motor rating (kW)	Inverter type	MCCB, RCD/ELCB Rated current (A)		MC type			
			w/ DCR	w/o DCR	MC1 (for input circuit)		MC2 (for output circuit)	
					w/ DCR	w/o DCR		
Three-phase 200 V	0.75	FRN0.75F1■-2□	5	10	SC-05	SC-05	SC-05	
	1.5	FRN1.5F1■-2□	10	15				
	2.2	FRN2.2F1■-2□		20				
	3.7	FRN3.7F1■-2□	20	30	SC-4-0	SC-5-1	SC-4-0	
	5.5	FRN5.5F1■-2□	30	50				
	7.5	FRN7.5F1■-2□	40	75	SC-5-1	SC-N1	SC-5-1	
	11	FRN11F1■-2□	50	100	SC-N1	SC-N2S	SC-N1	
	15	FRN15F1■-2□	75	125	SC-N2	SC-N3	SC-N2	
	18.5	FRN18.5F1■-2□	100	150	SC-N2S	SC-N4	SC-N2S	
	22	FRN22F1■-2□		175				
	30	FRN30F1■-2□	150	200	SC-N4	SC-N7	SC-N4	
	37	FRN37F1■-2□	175	250	SC-N5			
	45	FRN45F1■-2□	200	300	SC-N7	SC-N8	SC-N7	
	55	FRN55F1■-2□	250	350	SC-N8	SC-N11		
	75	FRN75F1■-2□	350	-	SC-N11	-	SC-N11	
	90	FRN90F1■-2□	400					
	110	FRN110F1■-2□	500		SC-N12			SC-N12
Three-phase 400 V	0.75	FRN0.75F1S-4E	5	5	SC-05	SC-05	SC-05	
	1.5	FRN1.5F1S-4E		10				
	2.2	FRN2.2F1S-4E	10	15				
	4.0	FRN4.0F1S-4E		20				
	5.5	FRN5.5F1S-4E	15	30	SC-4-0	SC-N1	SC-4-0	
	7.5	FRN7.5F1S-4E	20	40				
	11	FRN11F1S-4E	30	50	SC-4-0	SC-N2	SC-5-1	
	15	FRN15F1S-4E	40	60	SC-5-1			
	18.5	FRN18.5F1S-4E		75	SC-N1	SC-N2	SC-N1	
	22	FRN22F1S-4E	50	100	SC-N2	SC-N2S	SC-N2	
	30	FRN30F1S-4E	75	125				
	37	FRN37F1S-4E	100		SC-N2S	SC-N3	SC-N2S	
	45	FRN45F1S-4E		150	SC-N3	SC-N4	SC-N3	
	55	FRN55F1S-4E	125	200	SC-N4	SC-N5	SC-N4	
	75	FRN75F1S-4E	175	-	SC-N5	-	SC-N5	
	90	FRN90F1S-4E	200		SC-N7		SC-N7	
	110	FRN110F1S-4E	250		SC-N8		SC-N8	
	132	FRN132F1S-4E	300		SC-N11		SC-N11	
	160	FRN160F1S-4E	350					
	200	FRN200F1S-4E	500		SC-N12		SC-N12	
	220	FRN220F1S-4E						
	280	FRN280F1S-4E	600		SC-N14		-	SC-N14
	315	FRN315F1S-4E	700					
355	FRN355F1S-4E	800						
400	FRN400F1S-4E	1000	SC-N16	-		SC-N16		
450	FRN450F1S-4E							
500	FRN500F1S-4E				1200	610CM	610CM*	
560	FRN560F1S-4E	612CM*						

* Manufactured by Aichi Electric Works co., Ltd.

- The above table lists the rated current of MCCBs and RCD/ELCBs to be used in the power control panel with an internal temperature of lower than 50°C. The rated current is factored by a correction coefficient of 0.85 as the MCCBs' and RCDs'/ELCBs' original rated current is specified when using them in an ambient temperature of 40°C or lower. Select an MCCB and/or RCD/ELCB suitable for the actual short-circuit breaking capacity needed for your power systems.
- For the selection of the MC type, it is assumed that the **600V HIV (allowable ambient temperature: 75°C)** wires for the power input/output of the inverter are used. If an MC type for another class of wires is selected, the wire size suitable for the terminal size of both the inverter and the MC type should be taken into account.
- Use ELCBs with overcurrent protection.
- To protect your power systems from secondary accidents caused by the broken inverter, use an MCCB and/or RCD/ELCB with the rated current listed in the above table. Do not use an MCCB or RCD/ELCB with a rating higher than that listed.

Note 1) A box (■) in the above table replaces S (Standard type), E (EMC filter built-in type), H (DCR built-in type), or B or D/L (Waterproof type) depending on the product specifications.
 2) A box (□) in the above table replaces A, C, E, or J depending on the shipping destination.

Table 6.6 lists the relationship between the rated leakage current sensitivity of RCDs/ELCBs (with overcurrent protection) and wiring length of the output (secondary) sides of the inverter. Note that the sensitivity levels listed in the table are estimated typical values based on the results obtained by the test setup in the Fuji laboratory where each inverter drives a single motor.

Table 6.6 Rated Current Sensitivity of RCDs/ELCBs

Power supply voltage	Applicable motor rating (kW)	Wiring length and current sensitivity					
		10 m	30 m	50 m	100 m	200 m	300 m
Three-phase 200 V	0.75						
	1.5						
	2.2		30 mA				
	3.7						
	5.5						
	7.5				100 mA		
	11						
	15						
	18.5					200 mA	
	22						
	30						
	37						
	45						
	55						
75						500 mA	
90							
110							
Three-phase 400 V	0.75						
	1.5						
	2.2						
	4.0	30 mA					
	5.5						
	7.5						
	11				100 mA		
	15						
	18.5						
	22					200 mA	
	30						
	37						
	45						500 mA
	55						
	75						
	90						
	110						
	132						1000 mA (Atypical spec.)
	160						
200							
220							
280							
315							
355					1000 mA (Atypical spec.)	3000 mA (Atypical spec.)	
400							
450							
500							
560							

- Values listed above were obtained using Fuji ELCB EG or SG series applied to the test setup.
- The rated current of applicable motor rating indicates values for Fuji standard motor (4 poles, 50 Hz and 200 V 3-phase).
- The leakage current is calculated based on grounding of the single wire for 200V Δ connection and the neutral wire for 400V Y connection.
- Values listed above are calculated based on the static capacitance to the earth when the 600V IV wires are used in a metal conduit laid directly on the earth.
- Wiring length is the total length of wiring between the inverter and motor. If more than one motor is to be connected to a single inverter, the wiring length should be the total length of wiring between the inverter and motors.

Note For an EMC filter built-in type inverter, use an RCD/ELCB with higher rated leakage current sensitivity than specified one, or remove the built-in capacitive filter (grounding capacitor).

[2] Surge killers

A surge killer eliminates surge currents and noise from the power supply lines. Use of a surge killer is effective in preventing the electronic equipment, including inverters, from damage or malfunctioning caused by such surges and/or noise.

The applicable model of surge killer is the FSL-323. Figure 6.3 shows its external dimensions and application example. Refer to the catalog "Fuji Noise Suppressors (SH310: Japanese edition only)" for details. These products are available from Fuji Electric Technica Co., Ltd.

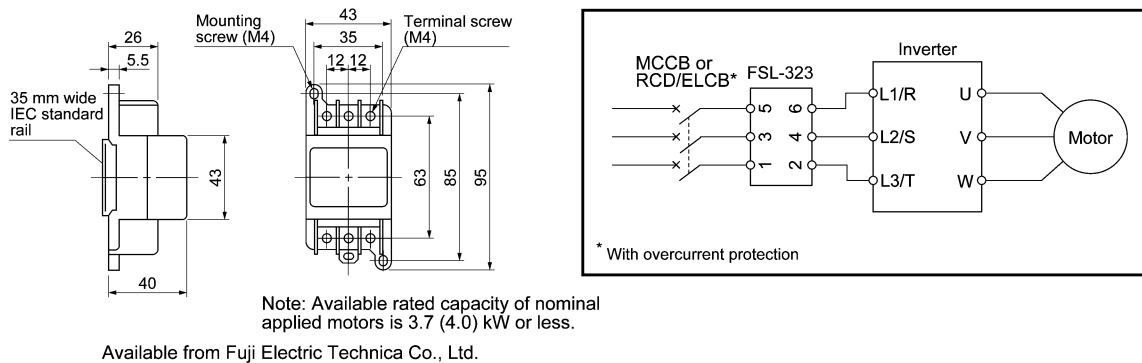

Figure 6.3 Dimensions of Surge Killer and Application Example

[3] Arresters

An arrester suppresses surge currents induced by lightning and noise invaded from the power supply lines. Use of an arrester is effective in preventing electronic equipment, including inverters, from damage or malfunctioning caused by such surges and/or noise.

Applicable arrester models are the CN23232 and CN2324E. Figure 6.4 shows their external dimensions and application examples. Refer to the catalog "Fuji Noise Suppressors (SH310: Japanese edition only)" for details. These products are available from Fuji Electric Technica Co., Ltd.

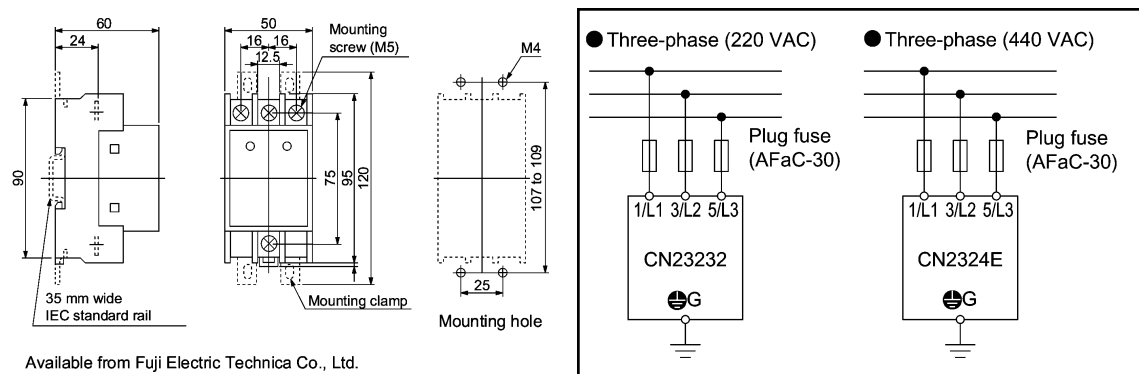
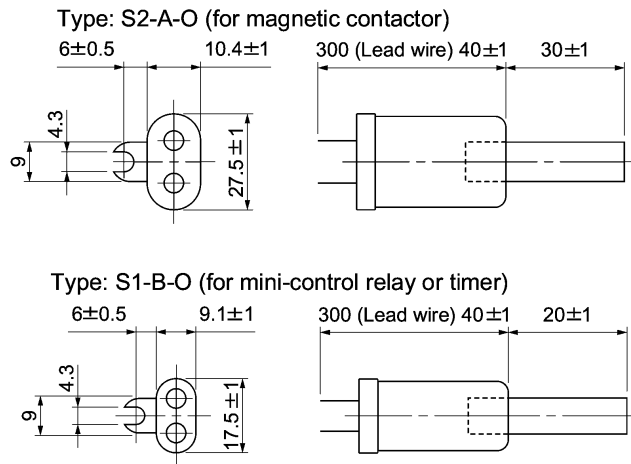

Figure 6.4 Arrester Dimensions and Application Examples

[4] Surge absorbers

A surge absorber suppresses surge currents and noise generated by magnetic contactors, mini-control relays and timers mounted near an inverter, preventing the inverter from malfunctioning.

Applicable surge absorber models are the S2-A-O and S1-B-O. Figure 6.5 shows their external dimensions. Refer to the catalog "Fuji Noise Suppressors (SH310: Japanese edition only)" for details. The surge absorbers are available from Fuji Electric Technica Co., Ltd.



Available from Fuji Electric Technica Co., Ltd.

Figure 6.5 Surge Absorber Dimensions

6.4 Selecting Options

6.4.1 Peripheral equipment options

[1] DC reactors (DCRs)

A DCR is mainly used for power supply normalization and for input power factor correction (for suppressing harmonics).

■ For power supply normalization

- Use a DCR when the capacity of a power supply transformer exceeds 500 kVA and is 10 times or more the rated inverter capacity. In this case, the percent reactance of the power source decreases, and harmonic components and their peak levels increase. These factors may break rectifiers or capacitors in the converter section of inverter, or decrease the capacitance of the capacitor (which can shorten the inverter's service life).
- Also use a DCR when there are thyristor-driven loads or when phase-advancing capacitors are being turned on/off.
- Use a DCR when the interphase voltage unbalance ratio of the inverter power source exceeds 2%.

$$\text{Interphase voltage unbalance (\%)} = \frac{\text{Max. voltage (V)} - \text{Min. voltage (V)}}{\text{3-phase average voltage (V)}} \times 67$$

■ For input power factor correction (for suppressing harmonics)

Generally a capacitor is used to correct the power factor of the load, however, it cannot be used in a system that includes an inverter. Using a DCR increases the reactance of inverter's power source so as to decrease harmonic components on the power source lines and correct the power factor of inverter. Using a DCR corrects the input power factor to approximately 95%.

- Note**
- At the time of shipping, a jumper bar is connected across terminals P1 and P (+) on the terminal block. Remove the jumper bar when connecting a DCR.
 - If a DCR is not going to be used, do not remove the jumper bar.

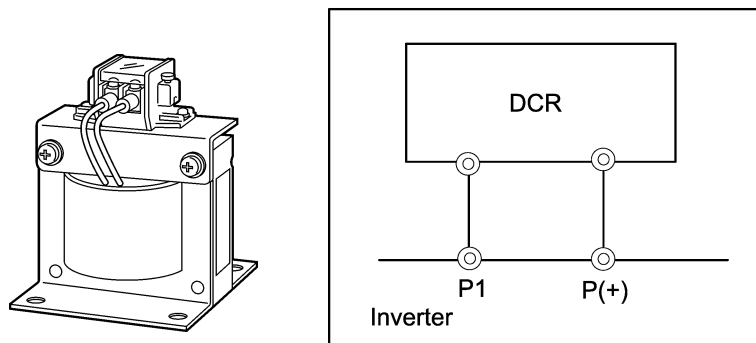

Figure 6.6 External View of a DCR and Application Example

Table 6.7 DCRs

Power supply voltage	Applicable motor rating (kW)	Inverter type	DCR				
			Type	Rated current (A)	Inductance (mH)	Coil resistance (mΩ)	Generated loss (W)
Three-phase 200 V	0.75	FRN0.75F1■-2□	DCR2-0.75	5.0	7.0	123	2.8
	1.5	FRN1.5F1■-2□	DCR2-1.5	8.0	4.0	57.5	4.6
	2.2	FRN2.2F1■-2□	DCR2-2.2	11	3.0	43	6.7
	3.7	FRN3.7F1■-2□	DCR2-3.7	18	1.7	21	8.8
	5.5	FRN5.5F1■-2□	DCR2-5.5	25	1.2	16	14
	7.5	FRN7.5F1■-2□	DCR2-7.5	34	0.8	9.7	16
	11	FRN11F1■-2□	DCR2-11	50	0.6	7.0	27
	15	FRN15F1■-2□	DCR2-15	67	0.4	4.3	27
	18.5	FRN18.5F1■-2□	DCR2-18.5	81	0.35	3.1	29
	22	FRN22F1■-2□	DCR2-22A	98	0.3	2.7	38
	30	FRN30F1■-2□	DCR2-30B	136	0.23	1.1	37
	37	FRN37F1■-2□	DCR2-37B	167	0.19	0.82	47
	45	FRN45F1■-2□	DCR2-45B	203	0.16	0.62	52
	55	FRN55F1■-2□	DCR2-55B	244	0.13	0.79	55
	75	FRN75F1■-2□	DCR2-75C	358	0.05	0.39	96
	90	FRN90F1■-2□	DCR2-90C	431	0.042	0.24	100
110	FRN110F1■-2□	DCR2-110C	552	0.034	0.20	126	
Three-phase 400 V	0.75	FRN0.75F1S-4E	DCR4-0.75	2.5	30	440	2.5
	1.5	FRN1.5F1S-4E	DCR4-1.5	4.0	16	235	4.8
	2.2	FRN2.2F1S-4E	DCR4-2.2	5.5	12	172	6.8
	4.0	FRN4.0F1S-4E	DCR4-3.7	9.0	7.0	74.5	8.1
	5.5	FRN5.5F1S-4E	DCR4-5.5	13	4.0	43	10
	7.5	FRN7.5F1S-4E	DCR4-7.5	18	3.5	35.5	15
	11	FRN11F1S-4E	DCR4-11	25	2.2	23.2	21
	15	FRN15F1S-4E	DCR4-15	34	1.8	18.1	28
	18.5	FRN18.5F1S-4E	DCR4-18.5	41	1.4	12.1	29
	22	FRN22F1S-4E	DCR4-22A	49	1.2	10.0	35
	30	FRN30F1S-4E	DCR4-30B	71	0.86	4.00	35
	37	FRN37F1S-4E	DCR4-37B	88	0.70	2.80	40
	45	FRN45F1S-4E	DCR4-45B	107	0.58	1.90	44
	55	FRN55F1S-4E	DCR4-55B	131	0.47	1.70	55
	75	FRN75F1S-4E	DCR4-75C	178	0.231	1.47	97
	90	FRN90F1S-4E	DCR4-90C	214	0.2	1.17	111
	110	FRN110F1S-4E	DCR4-110C	261	0.166	0.93	122
	132	FRN132F1S-4E	DCR4-132C	313	0.148	0.74	159
	160	FRN160F1S-4E	DCR4-160C	380	0.122	0.61	185
	200	FRN200F1S-4E	DCR4-200C	475	0.098	0.46	218
220	FRN220F1S-4E	DCR4-220C	524	0.087	0.40	231	
280	FRN280F1S-4E	DCR4-280C	649	0.069	0.29	270	
315	FRN315F1S-4E	DCR4-315C	739	0.061	0.24	285	
355	FRN355F1S-4E	DCR4-355C	833	0.054	0.20	308	
400	FRN400F1S-4E	DCR4-400C	938	0.048	0.17	323	
450	FRN450F1S-4E	DCR4-450C	1056	0.043	0.14	338	
500	FRN500F1S-4E	DCR4-500C	1173	0.039	0.12	384	
560	FRN560F1S-4E	DCR4-560C	1314	0.035	0.25	580	

- Note
- 1) Generated losses listed in the above table are approximate values that are calculated according to the following conditions:
 - The power source is 3-phase 200 V/400 V 50 Hz with 0% interphase voltage unbalance ratio.
 - The power source capacity uses the larger of either 500 kVA or 10 times the rated capacity of the inverter.
 - The motor is a 4-pole standard model at full load (100%).
 - An AC reactor (ACR) is not connected.
 - 2) A box (■) in the above table replaces S (Standard type), E (EMC filter built-in type), H (DCR built-in type), or B or D/L (Waterproof type) depending on the product specifications.
 - 3) A box (□) in the above table replaces A, C, E, or J depending on the shipping destination.

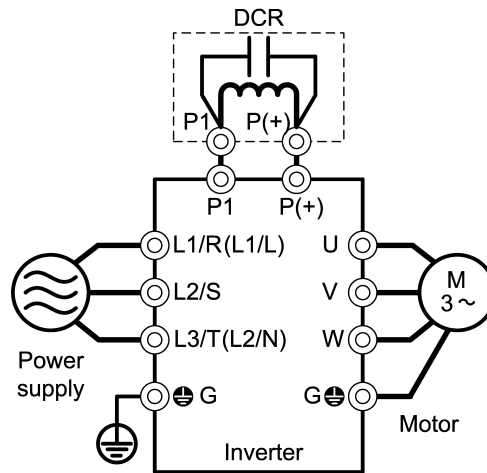

Figure 6.7 Applying a DC Reactor (DCR)

[2] AC reactors (ACRs)

Use an ACR when the converter part of the inverter should supply very stable DC power, for example, in DC link bus operation (shared PN operation). Generally, ACRs are used for correction of voltage waveform and power factor or for power supply normalization, but not for suppressing harmonic components in the power lines. For suppressing harmonic components, use a DCR.

An ACR should be also used when the power source is extremely unstable; for example, when the power source involves an extremely large interphase voltage unbalance.

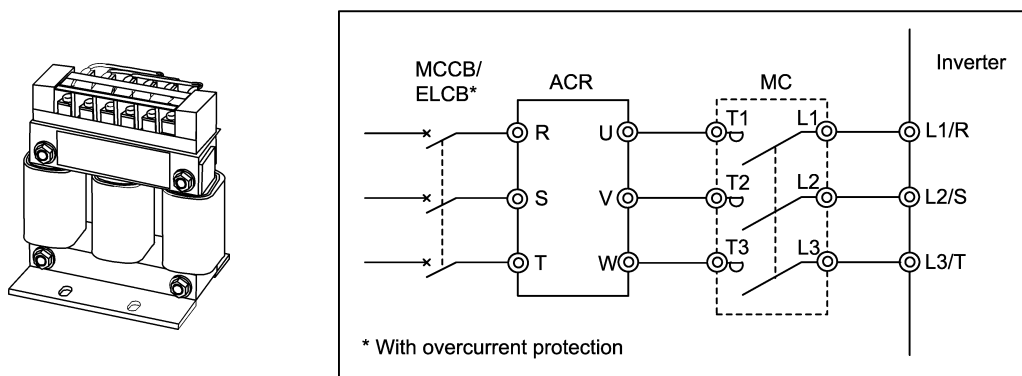

Figure 6.8 External View of ACR and Application Example

Table 6.8 ACR

Power supply voltage	Applicable motor rating (kW)	Inverter type	ACR					
			Type	Rated current (A)	Reactance (mΩ/phase)		Coil resistance (mΩ)	Generated loss (W)
					50 Hz	60(Hz)		
Three-phase 200 V	0.75	FRN0.75F1■-2□	ACR2-0.75A	5	493	592	-	12
	1.5	FRN1.5F1■-2□	ACR2-1.5A	8	295	354	-	14
	2.2	FRN2.2F1■-2□	ACR2-2.2A	11	213	256	-	16
	3.7	FRN3.7F1■-2□	ACR2-3.7A	17	218	153	-	23
	5.5	FRN5.5F1■-2□	ACR2-5.5A	25	87.7	105	-	27
	7.5	FRN7.5F1■-2□	ACR2-7.5A	33	65.0	78.0	-	30
	11	FRN11F1■-2□	ACR2-11A	46	45.5	54.7	-	37
	15	FRN15F1■-2□	ACR2-15A	59	34.8	41.8	-	43
	18.5	FRN18.5F1■-2□	ACR2-18.5A	74	28.6	34.3	-	51
	22	FRN22F1■-2□	ACR2-22A	87	24.0	28.8	-	57
	30	FRN30F1■-2□	ACR2-37	200	10.8	13.0	0.5	28.6
	37	FRN37F1■-2□						40.8
	45	FRN45F1■-2□	ACR2-55	270	7.50	9.00	0.375	47.1
	55	FRN55F1■-2□						66.1
	75	FRN75F1■-2□	ACR2-75	390	5.45	6.54	0.250	55.1
90	FRN90F1■-2□	ACR2-90	450	4.73	5.67	0.198	61.5	
110	FRN110F1■-2□	ACR2-110	500	4.25	5.10	0.180	83.4	
Three-phase 400 V	0.75	FRN0.75F1S-4E	ACR4-0.75A	2.5	1920	2300	-	10
	1.5	FRN1.5F1S-4E	ACR4-1.5A	3.7	1160	1390	-	11
	2.2	FRN2.2F1S-4E	ACR4-2.2A	5.5	851	1020	-	14
	4.0	FRN4.0F1S-4E	ACR4-3.7A	9	512	615	-	17
	5.5	FRN5.5F1S-4E	ACR4-5.5A	13	349	418	-	22
	7.5	FRN7.5F1S-4E	ACR4-7.5A	18	256	307	-	27
	11	FRN11F1S-4E	ACR4-11A	24	183	219	-	40
	15	FRN15F1S-4E	ACR4-15A	30	139	167	-	46
	18.5	FRN18.5F1S-4E	ACR4-18.5A	39	114	137	-	57
	22	FRN22F1S-4E	ACR4-22A	45	95.8	115	-	62
	30	FRN30F1S-4E	ACR4-37	100	41.7	50	2.73	38.9
	37	FRN37F1S-4E						55.7
	45	FRN45F1S-4E	ACR4-55	135	30.8	37	1.61	50.2
	55	FRN55F1S-4E						70.7
	75	FRN75F1S-4E	ACR4-75 *	160	25.8	31	1.16	65.3
	90	FRN90F1S-4E	ACR4-110	250	16.7	20	0.523	42.2
	110	FRN110F1S-4E						60.3
	132	FRN132F1S-4E						119
	160	FRN160F1S-4E	ACR4-220 *	561	10.0	12	0.236	56.4
	200	FRN200F1S-4E						90.4
220	FRN220F1S-4E	107						
280	FRN280F1S-4E	Consult your Fuji Electric representative case by case for these classes of inverters.						
315	FRN315F1S-4E							
355	FRN355F1S-4E							
400	FRN400F1S-4E							
450	FRN450F1S-4E							
500	FRN500F1S-4E							
560	FRN560F1S-4E							

*Cool these reactors using a fan with 3 m/s or more WV (Wind Velocity).

- Note
- Generated losses listed in the above table are approximate values that are calculated according to the following conditions:
 - The power source is 3-phase 200 V/400 V 50 Hz with 0% interphase voltage unbalance ratio.
 - The power source capacity uses the larger of either 500 kVA or 10 times the rated capacity of the inverter.
 - The motor is a 4-pole standard model at full load (100%).
 - A box (■) in the above table replaces S (Standard type), E (EMC filter built-in type), H (DCR built-in type), or B or D/L (Waterproof type) depending on the product specifications.
 - A box (□) in the above table replaces A, C, E, or J depending on the shipping destination.

[3] Output circuit filters (OFLs)

Insert an OFL in the inverter power output circuit to:

- Suppress the voltage fluctuation at the motor power terminals
This protects the motor from insulation damage caused by the application of high voltage surge currents from the 400 V class of inverters.
- Suppress leakage current (due to higher harmonic components) from the inverter output lines
This reduces the leakage current when the motor is connected by long power feed lines. Keep the length of the power feed line less than 400 m.
- Minimize radiation and/or induction noise issued from the inverter output lines
OFLs are effective noise suppression device for long wiring applications such as that used at plants.

Note Use an ACR within the allowable carrier frequency range specified by function code F26 (Motor sound (carrier frequency)). Otherwise, the filter will overheat.

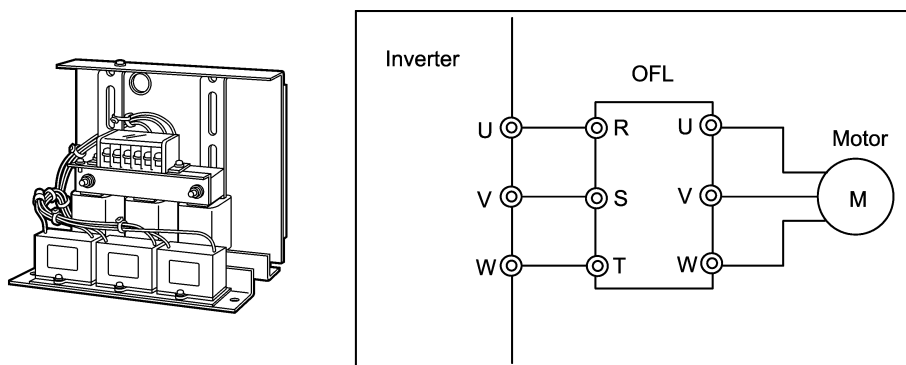

Figure 6.9 External View of OFL and Application Example

Table 6.9 OFL (OFL- ***-4A)

Power supply voltage	Applicable motor rating (kW)	Inverter type	Filter type	Rated current (A)	Overload capability	Inverter power input voltage	Carrier frequency - allowable range (kHz)	Maximum frequency (Hz)
Three-phase 400 V	0.75	FRN0.75F1S-4E	OFL- 1.5-4A	3.7	150 % for 1 min. 200 % for 0.5 sec	Three-phase 380 to 460 V 50/60 Hz	0.75 to 15	400
	1.5	FRN1.5F1S-4E						
	2.2	FRN2.2F1S-4E	OFL- 3.7-4A	9				
	4.0	FRN4.0F1S-4E						
	5.5	FRN5.5F1S-4E	OFL- 7.5-4A	18				
	7.5	FRN7.5F1S-4E	OFL- 15-4A	30				
	11	FRN11F1S-4E						
	15	FRN15F1S-4E	OFL- 22-4A	45				
	18.5	FRN18.5F1S-4E						
	22	FRN22F1S-4E	OFL- 30-4A	60				
	30	FRN30F1S-4E						
	37	FRN37F1S-4E	OFL- 37-4A	75				
	45	FRN45F1S-4E	OFL- 45-4A	91				
	55	FRN55F1S-4E	OFL- 55-4A	112				
	75	FRN75F1S-4E	OFL- 75-4A	150				
	90	FRN90F1S-4E	OFL- 90-4A	176				
	110	FRN110F1S-4E	OFL- 110-4A	210				
	132	FRN132F1S-4E	OFL- 132-4A	253				
	160	FRN160F1S-4E	OFL- 160-4A	304				
	200	FRN200F1S-4E	OFL- 200-4A	377				
220	FRN220F1S-4E	OFL- 220-4A	415					
280	FRN280F1S-4E	OFL- 280-4A	520					
315	FRN315F1S-4E	OFL- 315-4A	585					
355	FRN355F1S-4E	OFL- 355-4A	650					
400	FRN400F1S-4E	OFL- 400-4A	740					
450	FRN450F1S-4E	OFL- 450-4A	840					
500	FRN500F1S-4E	OFL- 500-4A	960					
	560	FRN560F1S-4E	Consult your Fuji Electric representative case by case for these classes of inverters.					

- Note 1) For inverter type of 30 kW (FRN30F1) or above, capacitor(s) of the OFL are to be installed separately.
2) The OFL-***-4A models have no restrictions on carrier frequency.

[4] Ferrite ring reactors for reducing radio noise (ACL)

An ACL is used to reduce radio frequency noise emitted by the inverter.

An ACL suppresses the outflow of high frequency harmonics caused by switching operation for the power supply lines inside the inverter. Pass the power source (primary) lines together through the ACL.

If wiring length between the inverter and motor is less than 20 m, insert an ACL to the power source (primary) lines; if it is more than 20 m, insert it to the power output (secondary) lines of the inverter.

Wire size is determined depending upon the ACL size (I.D.) and installation requirements.

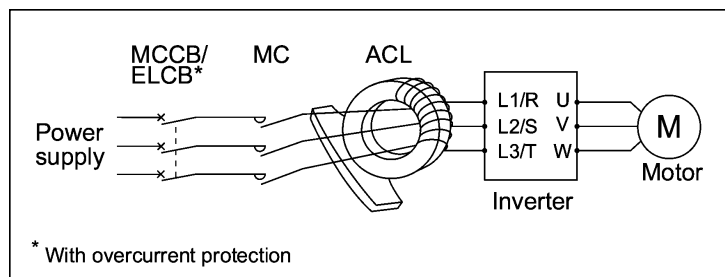
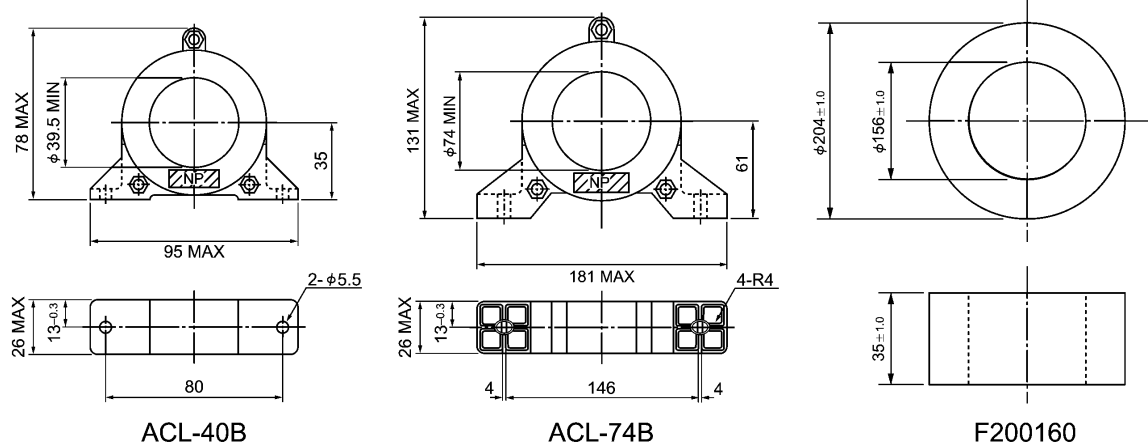

Figure 6.10 Dimensions of ACL and Application Example

Table 6.10 ACL

Ferrite ring type	Installation requirements for making 4 turns		Wire size (mm ²)
	Number of rings	Number of turns	
ACL-40B	1	4	2.0
			3.5
			5.5
	2	2	8
			14
ACL-74B	1	4	8
			14
			22
	2	2	38
			60
			100
	4	1	150
			200
			250
			325

The installation requirements and wire size listed above are determined for allowing three wires (3-phase input lines) to pass through the corresponding ferrite ring.

6.4.2 Options for operation and communications

[1] External potentiometer for frequency setting

An external potentiometer may be used to set the frequency command. Connect the potentiometer to control signal terminals [11] to [13] of the inverter as shown in Figure 6.11.

Model: RJ-13 (BA-2 B-characteristics, 1 kΩ)

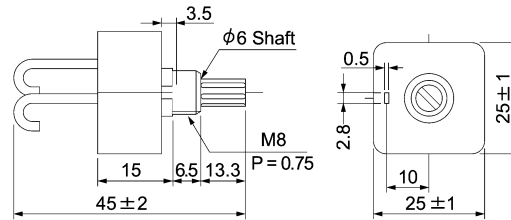

Dial plate type: YS549810-0

Knob type: MSS-2SB

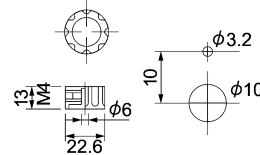
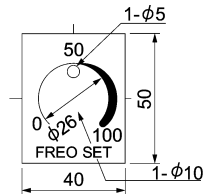

Note: The dial plate and knob must be ordered as separate items.
Available from Fuji Electric Technica Co., Ltd.

Model: WAR3W (3W B-characteristics, 1 kΩ)

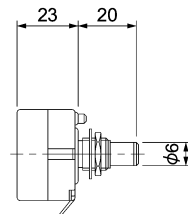

Dial plate

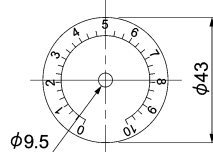

Knob

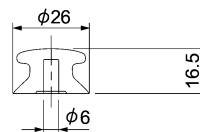

Note: The dial plate and knob are supplied together with the external potentiometer WAR3W.
Available from Fuji Electric Technica Co., Ltd.

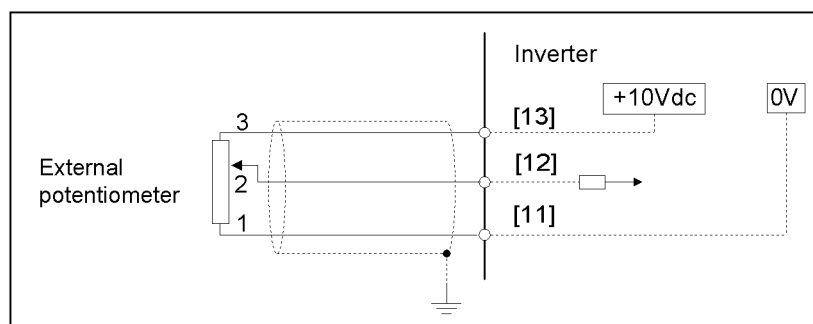

Figure 6.11 External Potentiometer Dimensions and Application Example

[2] Multi-function keypad

Mounting the multi-function keypad on a FRENIC-Eco series inverter or connecting it to the inverter with an optional remote operation extension cable (CB-5S, CB-3S, or CB-1S) allows you to operate the inverter locally or remotely (from the keypad in hand or mounted on a panel), respectively.

In addition, the multi-function keypad can be used for copying function code data from a FRENIC-Eco series inverter to other ones.



[3] Extension cable for remote operation

The extension cable connects the inverter with the keypad (standard or multi-function) or USB-RS-485 converter to enable remote operation of the inverter. The cable is a straight type with RJ-45 jacks and its length is selectable from 5, 3, and 1 m.

Note Do not use an off-the-shelf LAN cable for connection of the multi-function keypad.

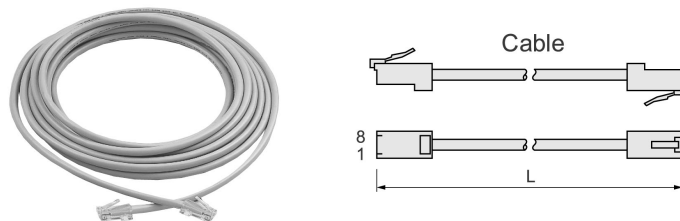

Table 6.11 Extension Cable Length for Remote Operation

Type	Length (m)
CB-5S	5
CB-3S	3
CB-1S	1

You can use these cable to connect RS-485 level converter to FRENIC-Eco inverters with some limitations described in "RS-485 communications port," in Chapter 8, Section 8.4.1 "Terminal functions."

[4] RS-485 communications card

The RS-485 communications card is exclusively designed for use with the FRENIC-Eco series of inverters and enables extended RS-485 communication in addition to the standard RS-485 communication (via the RJ-45 connector for connecting the keypad.)

The main functions include the following:

- Connecting the inverter to host equipment such as a PC or PLC, which enables the inverter to be controlled as a slave device.
- Operating the inverters by frequency command setting, forward/reverse running/stopping, coast-to-stop and resetting, etc.
- Monitoring the operation status of the inverter, e.g., output frequency, output current and alarm information, etc.
- Setting function code data.

Note that the card does not support any standard/multi-function keypad.

Table 6.12 Transmission Specifications

Item	Specifications		
Communication protocol	SX protocol (for exclusive use with FRENIC Loader)	Modbus RTU (Conforming to Modicon's Modbus RTU)	Fuji general-purpose inverter protocol
Electrical specifications	EIA RS-485		
Number of units connected	Host: 1 unit, Inverter: 31 units		
Transmission rate	2400, 4800, 9600, 19200, and 38400 bps		
Synchronization system	Asynchronous start-stop system		
Transmission method	Half-duplex		
Maximum length of communication network (m)	500 (including tap-offs for multi-drop connection)		

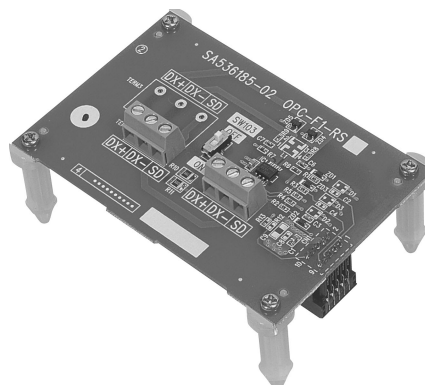

[5] Relay output card

The relay output card mounted on your FRENIC-Eco series of inverters converts transistor outputs at [Y1] to [Y3] on the inverter to relay outputs--three pairs of transfer contacts (SPDT).

Note When the relay output card is mounted, transistor output terminals [Y1] to [Y3] cannot be used.

■ Terminal assignment

The relay output terminals are assigned as shown below. Basically, the meaning of the relay outputs follows that of the transistor outputs [Y1] to [Y3], which is determined by their corresponding function codes.

Table 6.13 Terminal Assignment

Terminal Symbol	Terminal Name	Description
[Y1A/Y1B/Y1C]	Relay Output 1	These are relay outputs directly linked to transistor outputs [Y1] to [Y3]. Each relay is excited when its corresponding signal ([Y1], [Y2], or [Y3]) is ON. When excited, the relays [Y1A] - [Y1C], [Y2A] - [Y2C], and [Y3A] - [Y3C] are closed, and ones between [Y1B] - [Y1C], [Y2B] - [Y2C], and [Y3B] - [Y3C] are opened. In this manner, the signals corresponding to function codes E20 to E22 (such as inverter running, frequency arrival, and motor overload early warning signals) can be output as contact signals.
[Y2A/Y2B/Y2C]	Relay Output 2	
[Y3A/Y3B/Y3C]	Relay Output 3	

Note When the inverter's control power is OFF, all the B - C contact pairs are short-circuited. If you are using negative logic to realize fail-safe operation, make sure that this does not cause any logic fault or confliction.

■ Electrical specifications

Table 6.14 Electrical Specifications

Item	Specification
Contact capacity	250 VAC, 0.3 A ($\cos\phi = 0.3$) or 48 VDC, 0.5 A (resistive load)
Contact life	200 thousand operations (with ON/OFF intervals of 1 second)

Note If you anticipate frequent operations (ON/OFF switching) of relays (for example, if you deliberately use a signal for limiting the inverter's output to control the main current), be sure to use the transistor signals at terminals [Y1] through [Y3].

Wire properly, referring to the terminal allocation and symbol diagram, the internal block diagram, and the terminal and wiring specification table shown below.

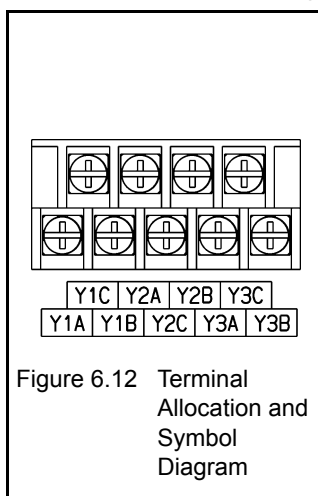
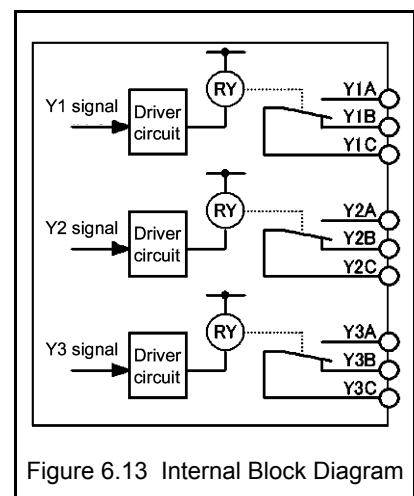

Table 6.15 Terminal Size & Recommended Wire Gauge

Terminal Size & Recommended Wire Gauge	
Terminal Size	M3
Tightening Torque	0.7 N·m
Recommended Wire Gauge*	0.75 mm ²

* A 600 V HIV wire with allowable temperature of 75°C is recommended. An ambient temperature of 50°C is assumed.



Note To prevent noise from causing malfunctioning, separate signal wires for the control circuit as far apart as possible from those for the main circuits. Also, inside the inverter, bundle and fix the wires for the control circuit so that they do not come into direct contact with live parts of the main circuits (for example, the main circuit terminal block).

[6] DeviceNet interface card

The DeviceNet interface card OPC-F1-DEV connects the FRENIC-Eco to a DeviceNet master unit. Mounting this card on the FRENIC-Eco makes it possible from the DeviceNet master unit to set up run/frequency commands, monitor the inverter running status, and configure or refer to function codes required for running.

Table 6.16 Communications Specifications

Item	Specifications			
No. of nodes connected	64 at maximum (including the master)			
MAC ID	0 to 63			
Insulation	500 VDC (photocoupler insulation)			
Transmission rate	500 kbps/250 kbps/125 kbps			
Maximum cable length (Thick cable)	Transmission rate	500 kbps	250 kbps	125 kbps
	Trunk line length	100 m	250 m	500 m
	Drop line length	6 m	6 m	6 m
	Total length of drop lines	39 m	78 m	156 m
Messages supported	1. I/O message (Poll, Change of State) 2. Explicit Message			
Vendor ID	319 (Fuji Electric Co., Ltd.)			
Device type	AC drive (code: 2)			
Product code	9217			
Applicable device profile	AC Drive			
No. of input/output bytes	Max. 16 bytes (8 bytes for input and output each) * Depending upon the AC Drive profile.			
Applicable DeviceNet specifications	DeviceNet Specifications Release 2.0			
Node type	Group 2 only server			
Network power consumption	Max. 50 mA, 24 VDC Note: The network power should be supplied from an external power supply.			

Items not listed above are compliant with the inverter or DeviceNet specifications.

Table 6.17 DeviceNet Connector Specifications

Layout of terminal pins (Detachable screw connector for plug connection)

Pin #	ID color of wire sheath	Pin assignment	Description
1	Black	V-	Power supply (24 VDC, - side)
2	Blue	CAN_L	Signal line
3	Metallic	SHIELD	Cable shield
4	White	CAN_H	Signal line
5	Red	V+	Power supply (24 VDC, + side)

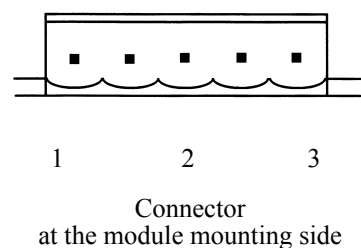

[7] PROFIBUS DP interface card

Mounting the PROFIBUS DP interface card on the FRENIC-Eco makes it possible from the PROFIBUS DP master unit to set up run/frequency commands, monitor the inverter running status, and configure or refer to all function codes.

Table 6.18 General Specifications

Item	Specifications
Operating ambient temperature	-10 to +50°C
Operating ambient humidity	5 to 95% RH (There shall be no condensation.)
External dimensions	94 x 63 mm
Applicable inverter	FRENIC-Eco series (with all versions)

Table 6.19 PROFIBUS-DP Communications Specifications

Item		Specifications	Remarks
Transmission section	Lines	RS-485 (insulated cable)	
	Cable length	See the table below.	
	Transmission speed	9.6 kbps to 12 Mbps (auto configuration)	To be specified in the master node
	Protocol	PROFIBUS-DP (DP-V0)	IEC 61158 and 61784
Connector		6-pin terminal block	Manufactured by Phoenix Contact Inc.
Control section	Controller	SPC3 (Siemens)	
	Comm. buffer	1472 byte (SPC3 built-in memory)	
Addressing		By on-board node address switches (rotary switches) (0 to 99) or By inverter's function code o31 (data = 0 to 125)	The o31 setting is effective when both address switches are set to 0.
Diagnostics		Detection of wire break	
		Detection of the illegal configuration	

Table 6.20 Maximum Length per Segment for PROFIBUS DP Specific Cable

Transmission speed	Maximum cable length (m) per segment
9.6 Kbps	1200
19.2 Kbps	1200
93.75 Kbps	1000
187.5 Kbps	1000
500 Kbps	400
1.5 Mbps	200
3 Mbps	100
6 Mbps	100
12 Mbps	100

[8] LONWORKS interface card

The LONWORKS interface card OPC-F1-LNW connects the FRENIC-Eco to a peripheral device (master) via LONWORKS interface. Mounting the LONWORKS interface card on the FRENIC-Eco makes it possible from the peripheral device (master) to set up run/frequency commands, monitor the inverter running status, and configure or refer to function codes required for running, as well as exchanging data with the peripheral device.

Table 6.21 General Specifications

Item	Specifications
Operating ambient temperature	-10 to +85°C
Operating ambient humidity	5 to 95% RH (There shall be no condensation.)
External dimensions	94 x 63 x 23.5 mm
Applicable inverter	FRENIC-Eco series (with all software versions)

Table 6.22 Communications Specifications

Item	Specifications
Transmission speed	78 kbps
Communications IC	FT3120-E4S40 Smart Transceiver
Transceiver	TP/FT-10 (Free topology)
Network protocol	LonTalk protocol
Network variables (NVs)	62
Configuration properties	24
Applicable profile	LonMark3.3 Variable Speed Motor Drive functional Profile Version 1.1

[9] Inverter support loader software

FRENIC Loader is an inverter support software which enables the inverter to be operated via the standard RS-485 communications port. The main functions include the following:

- Easy editing of function code data
- Monitoring the operation statuses of the inverter such as I/O monitor and multi-monitor
- Operation of inverters on a PC screen (Windows-based only)

 Refer to Chapter 5 "RUNNING THROUGH RS-485 COMMUNICATION" for details.

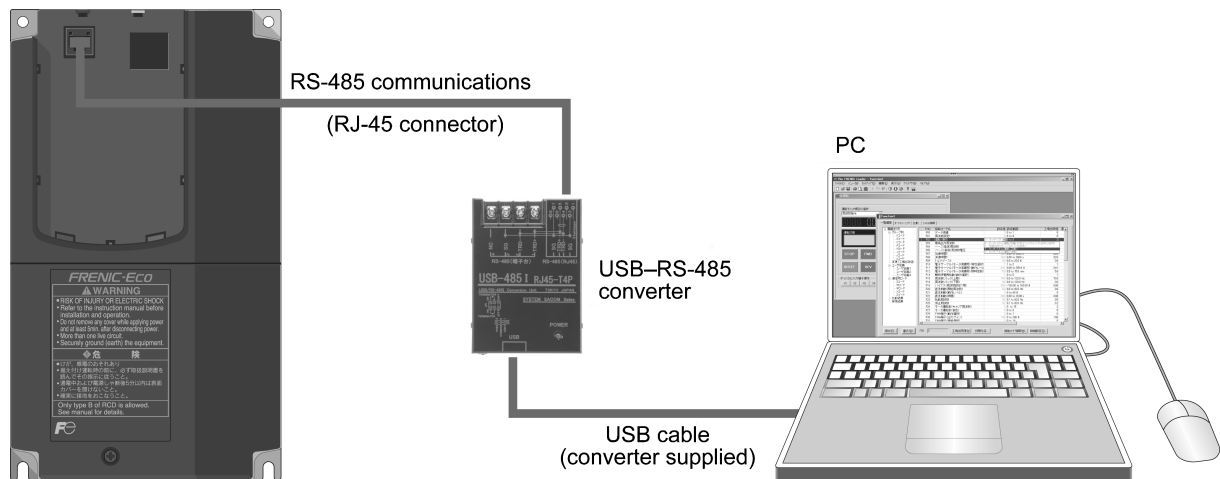

6.4.3 Extended installation kit options

[1] Panel-mount Adapter

This adapter allows you to mount your FRENIC-Eco series of inverters using the mounting holes for an existing inverter (FRENIC 5000P11S 5.5 kW/15 kW/30 kW).

(The FRENIC5000P11S 7.5 kW/11 kW/18.5 kW/22 kW can be replaced with the FRENIC-Eco series without this adapter.)

Table 6.23 Panel-mount Adapter

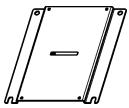
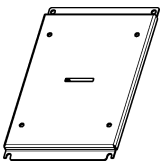
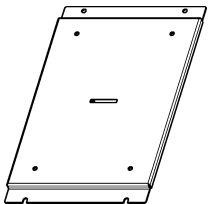

Model Name of Adapter and Accompanying Screws				Applicable Inverter Models	
				FRENIC-Eco	FRENIC5000P11S
MA-F1-5.5		4 (M5 × 15)	Cross recessed pan head screws with captive washer	FRN5.5F1S-2□ FRN5.5F1S-4□	FRN5.5P11S-2 FRN5.5P11S-4
MA-F1-15		4 (M8 × 25)	Cross recessed pan head screws with captive washer	FRN15F1S-2□ FRN15F1S-4□	FRN15P11S-2 FRN15P11S-4
MA-F1-30		4 (M8 × 25)	Cross recessed pan head screws with captive washer	FRN30F1S-2□ FRN30F1S-4□	FRN30P11S-2 FRN30P11S-4

Note A box (□) in the above table replaces A, C, E, or J depending on the shipping destination.

[2] Mounting Adapter for External Cooling

This adapter allows you to mount the FRENIC-Eco series of inverters (30 kW or less) on the panel in such a way that the heat sink assembly may be exposed to the outside. Using this adapter greatly reduces heat radiated or spread inside your panel. (For your inverter of 37 kW or above, remount its mounting base and mount it on the wall of your panel to realize the external cooling capability. Refer to FRENIC-Eco Instruction Manual (INR-S147-1059-E) Chapter 2 "MOUNTING AND WIRING OF THE INVERTER" for details.)

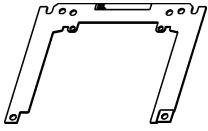
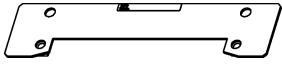
Table 6.24 Mounting Adapter for External Cooling

Model Name of Adapter and Accompanying Screws and Nuts	Applicable Inverter Models
<p>PB-F1-5.5</p>  <p>2 adapter plates</p> <p>4 (M5 × 8) Cross recessed head tapping screws</p> <p>6 (M6 × 15) Cross recessed pan head screws with captive washer</p> <p>6 (M6) Hexagon nuts</p>	<p>FRN5.5F1S-2□</p> <hr/> <p>FRN5.5F1S-4□</p>
<p>PB-F1-15</p>  <p>1 adapter plate</p> <p>6 (M8 × 25) Cross recessed pan head screws with captive washer</p> <p>4 (M8) Hexagon nuts</p>	<p>FRN7.5F1S-2□</p> <p>FRN11F1S-2□</p> <p>FRN15F1S-2□</p> <hr/> <p>FRN7.5F1S-4□</p> <p>FRN11F1S-4□</p> <p>FRN15F1S-4□</p>
<p>PB-F1-30</p>  <p>1 adapter plate</p> <p>6 (M8 × 25) Cross recessed pan head screws with captive washer</p> <p>4 (M8) Hexagon nuts</p>	<p>FRN18.5F1S-2□</p> <p>FRN22F1S-2□</p> <p>FRN30F1S-2□</p> <hr/> <p>FRN18.5F1S-4□</p> <p>FRN22F1S-4□</p> <p>FRN30F1S-4□</p>

Note A box (□) in the above table replaces A, C, E, or J depending on the shipping destination.

6.4.4 Meter options

[1] Frequency meters

Connect a frequency meter to analog signal output terminals [FMA] (+) and [11] (-) of the inverter to measure the frequency component selected by function code F31. Figure 6.14 shows the dimensions of the frequency meter and application example.

Model: TRM-45 (10 VDC, 1 mA)

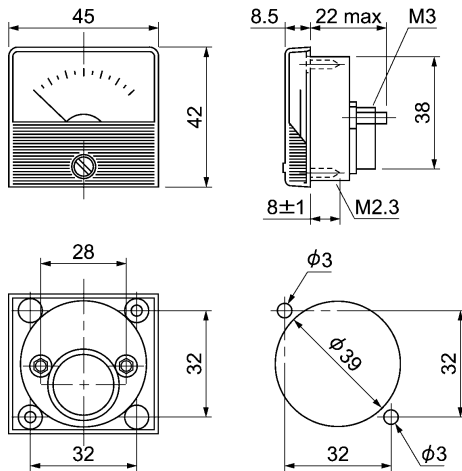

Available from Fuji Electric Technica Co., Ltd.

Model: FM-60 (10 VDC, 1 mA)

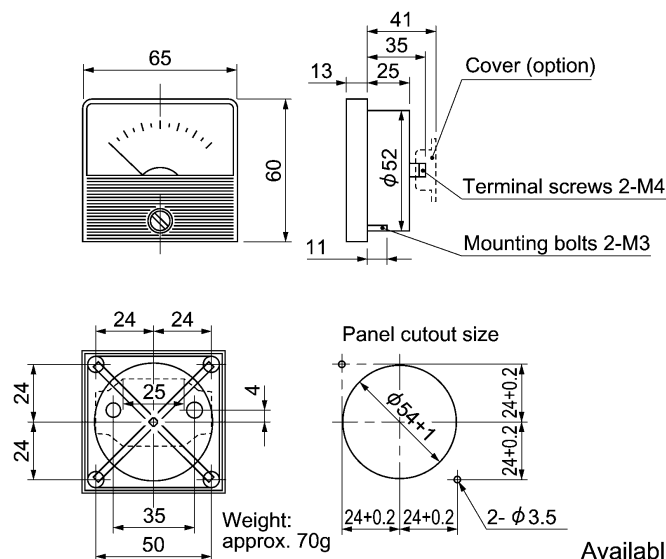

Available from Fuji Electric Technica Co., Ltd.

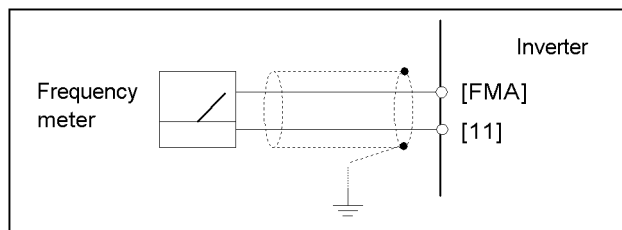

Figure 6.14 Frequency Meter Dimensions and Application Example

Part 4 Selecting Optimal Inverter Model



Chapter 7 SELECTING OPTIMAL MOTOR AND INVERTER CAPACITIES

Chapter 7

SELECTING OPTIMAL MOTOR AND INVERTER CAPACITIES

This chapter provides you with information about the inverter output torque characteristics, selection procedure, and equations for calculating capacities to help you select optimal motor and inverter models. This also helps you select braking resistors.

Contents

7.1	Selecting Motors and Inverters	7-1
7.1.1	Motor output torque characteristics	7-1
7.1.2	Selection procedure	7-3
7.1.3	Equations for selections	7-6
7.1.3.1	Load torque during constant speed running	7-6
7.1.3.2	Acceleration and deceleration time calculation	7-7
7.1.3.3	Heat energy calculation of braking resistor	7-10

7.1 Selecting Motors and Inverters

When selecting a general-purpose inverter, first select a motor and then inverter as follows:

- (1) Key point for selecting a motor: Determine what kind of load machine is to be used, calculate its moment of inertia, and then select the appropriate motor capacity
- (2) Key point for selecting an inverter: Taking into account the operation requirements (e.g., acceleration time, deceleration time, and frequency in operation) of the load machine to be driven by the motor selected in (1) above, calculate the acceleration/deceleration/braking torque.

This section describes the selection procedure for (1) and (2) above. First, it explains the output torque obtained by using the motor driven by the inverter (FRENIC-Eco).

7.1.1 Motor output torque characteristics

Figures 7.1 and 7.2 graph the output torque characteristics of motors at the rated output frequency individually for 50 Hz and 60 Hz base. The horizontal and vertical axes show the output frequency and output torque (%), respectively. Curves (a) through (d) depend on the running conditions.

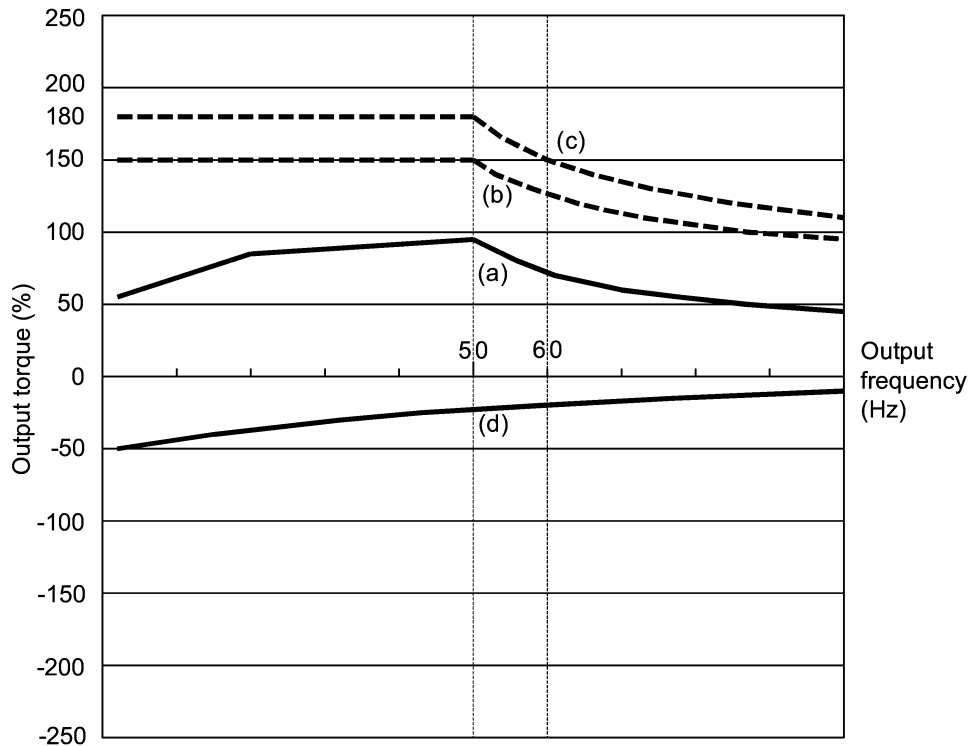

Figure 7.1 Output Torque Characteristics (Base frequency: 50 Hz)

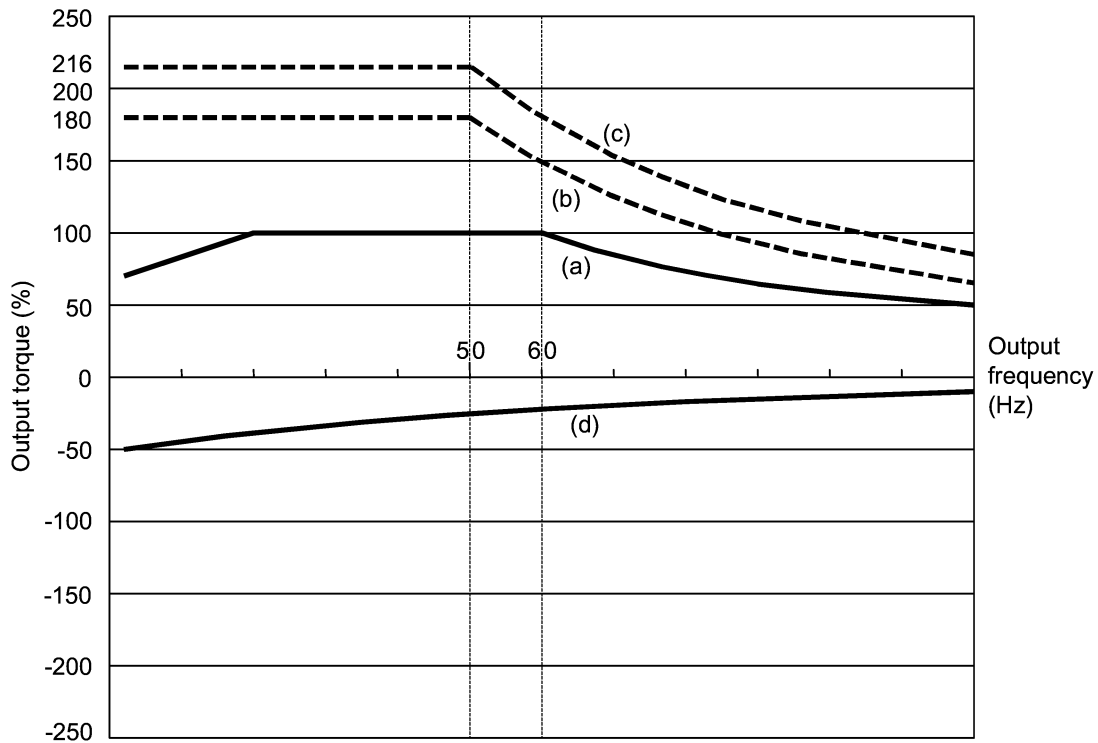

Figure 7.2 Output Torque Characteristics (Base frequency: 60 Hz)

(1) Continuous allowable driving torque (Curve (a) in Figures 7.1 and 7.2)

Curve (a) shows the torque characteristic that can be obtained in the range of the inverter continuous rated current, where the motor cooling characteristic is taken into consideration. When the motor runs at the base frequency of 60 Hz, 100 % output torque can be obtained; at 50 Hz, the output torque is somewhat lower than that in commercial power, and it further lowers at lower frequencies. The reduction of the output torque at 50 Hz is due to increased loss by inverter driving, and that at lower frequencies is mainly due to heat generation caused by the decreased ventilation performance of the motor cooling fan.

(2) Maximum driving torque in a short time (Curves (b) and (c) in Figures 7.1 and 7.2)

Curve (b) shows the torque characteristic that can be obtained in the range of the inverter rated current in a short time (the output torque is 150% for one minute) when quick torque-vector control (the auto torque boost and slip compensation functions are activated) is enabled. At that time, the motor cooling characteristics have little effect on the output torque.

Curve (c) shows an example of the torque characteristic when one class higher capacity inverter is used to increase the short-time maximum torque. In this case, the short-time torque is 20 to 30% greater than that when the standard capacity inverter is used.

(3) Starting torque (around the output frequency 0 Hz in Figures 7.1 and 7.2)

The maximum torque in a short time applies to the starting torque as it is.

(4) Braking torque (Curve (d) in Figures 7.1 and 7.2)

In braking of the motor, kinetic energy is converted to electrical energy and regenerated to the reservoir capacitor on the DC link bus of the inverter. Only the motor and inverter consume this energy as their internal losses, so the braking torque is as shown in curve (d).

Note that the torque value in % varies according to the inverter capacity.

7.1.2 Selection procedure

Figure 7.3 shows the general selection procedure for optimal inverters. Items numbered (1) through (3) are described on the following pages.

You may easily select inverter capacity if there are no restrictions on acceleration and deceleration times. If "there are any restrictions on acceleration or deceleration time" or "acceleration and deceleration are frequent," then the selection procedure is more complex than that of the constant speed running.

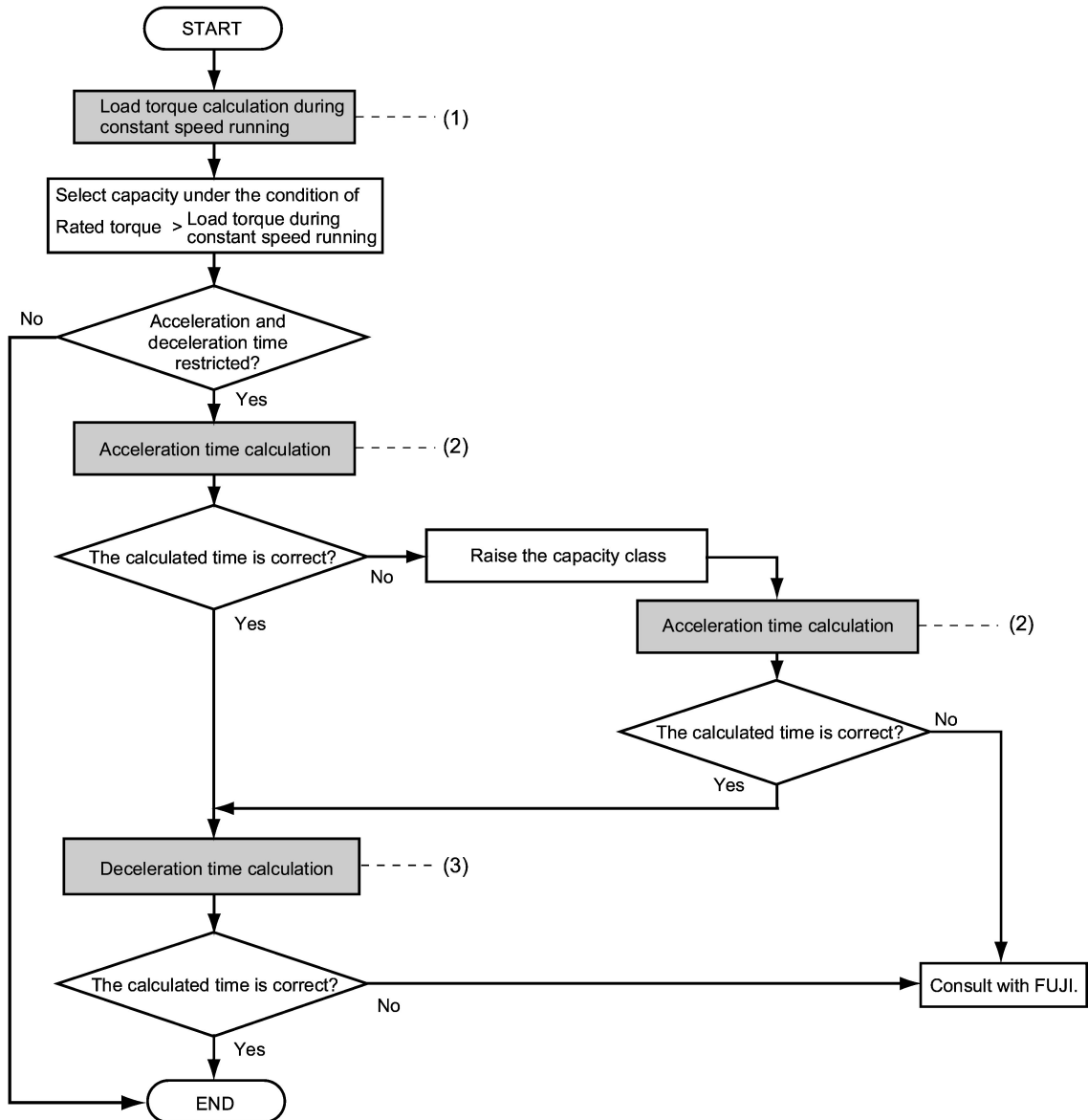

Figure 7.3 Selection Procedure

- (1) Calculating the load torque during constant speed running (For detailed calculation, refer to Section 7.1.3.1)

It is essential to calculate the load torque during constant speed running for all loads.

First calculate the load torque of the motor during constant speed running and then select a tentative capacity so that the continuous rated torque of the motor during constant speed running becomes higher than the load torque. To perform capacity selection efficiently, it is necessary to match the rated speeds (base speeds) of the motor and load. To do this, select an appropriate reduction-gear (mechanical transmission) ratio and the number of motor poles.

If the acceleration or deceleration time is not restricted, the tentative capacity can apply as a defined capacity.

- (2) Calculating the acceleration time (For detailed calculation, refer to Section 7.1.3.2)

When there are some specified requirements for the acceleration time, calculate it according to the following procedure:

- 1) Calculate the total moment of inertia for the load and motor
Calculate the moment of inertia for the load, referring to Section 7.1.3.2, "Acceleration and deceleration time calculation." For the motor, refer to the related motor catalogs. Sum them up.
- 2) Calculate the required minimum acceleration torque (See Figure 7.4)
The acceleration torque is the difference between the motor short-time output torque (base frequency: 60 Hz) explained in Section 7.1.1 (2), "Maximum driving torque in a short time" and the load torque (τ_L / η_G) during constant speed running calculated in the above (1). Calculate the required minimum acceleration torque over the whole range of speed.
- 3) Calculate the acceleration time
Assign the value calculated above to the equation (7.10) in Section 7.1.3.2, "Acceleration and deceleration time calculation" to calculate the acceleration time. If the calculated acceleration time is longer than the expected time, select the inverter and motor having one class higher capacity and calculate it again.

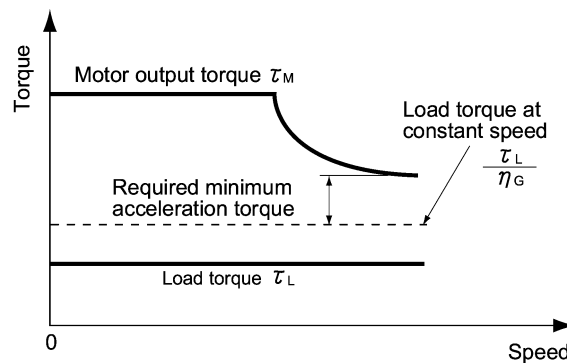

Figure 7.4 Example Study of Required Minimum Acceleration Torque

(3) Deceleration time (For detailed calculation, refer to Section 7.1.3.2)

To calculate the deceleration time, check the motor deceleration torque characteristics for the whole range of speed in the same way as for the acceleration time.

- 1) Calculate the total moment of inertia for the load and motor
Same as for the acceleration time.
- 2) Calculate the required minimum deceleration torque (See Figures 7.5 and 7.6.)
Same as for the acceleration time.
- 3) Calculate the deceleration time
Assign the value calculated above to the equation (7.11) to calculate the deceleration time in the same way as for the acceleration time. If the calculated deceleration time is longer than the requested time, select the inverter and motor having one class higher capacity and calculate it again.

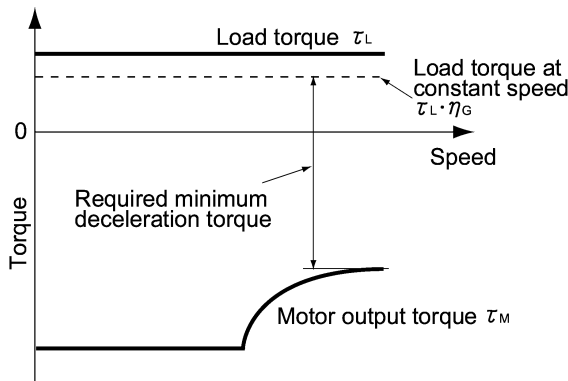

Figure 7.5 Example Study of Required Minimum Deceleration Torque (1)

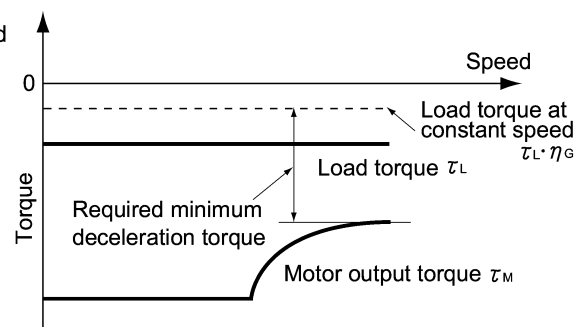

Figure 7.6 Example Study of Required Minimum Deceleration Torque (2)

7.1.3 Equations for selections

7.1.3.1 Load torque during constant speed running

[1] General equation

The frictional force acting on a horizontally moved load must be calculated. Calculation for driving a load along a straight line with the motor is shown below.

Where the force to move a load linearly at constant speed v (m/s) is F (N) and the motor speed for driving this is N_M (r/min), the required motor output torque τ_M (N·m) is as follows:

$$\tau_M = \frac{60 \cdot v}{2 \pi \cdot N_M} \cdot \frac{F}{\eta_G} \quad (\text{N} \cdot \text{m}) \quad (7.1)$$

where, η_G is Reduction-gear efficiency.

When the inverter brakes the motor, efficiency works inversely, so the required motor torque should be calculated as follows:

$$\tau_M = \frac{60 \cdot v}{2 \pi \cdot N_M} \cdot F \cdot \eta_G \quad (\text{N} \cdot \text{m}) \quad (7.2)$$

$(60 \cdot v) / (2 \pi \cdot N_M)$ in the above equation is an equivalent turning radius corresponding to speed v around the motor shaft.

The value F (N) in the above equations depends on the load type.

[2] Obtaining the required force F

Moving a load horizontally

A simplified mechanical configuration model is assumed as shown in Figure 7.7. If the mass of the carrier table is W_0 (kg), the load is W kg, and the friction coefficient of the ball screw is μ , then the friction force F (N) is expressed as follows, which is equal to a required force for driving the load:

$$F = (W_0 + W) \cdot g \cdot \mu \quad (\text{N}) \quad (7.3)$$

where, g is the gravity acceleration ($\approx 9.8 \text{ m/s}^2$).

Then, the required output torque around the motor shaft is expressed as follows:

$$\tau_M = \frac{60 \cdot v}{2 \pi \cdot N_M} \cdot \frac{(W_0 + W) \cdot g \cdot \mu}{\eta_G} \quad (\text{N} \cdot \text{m}) \quad (7.4)$$

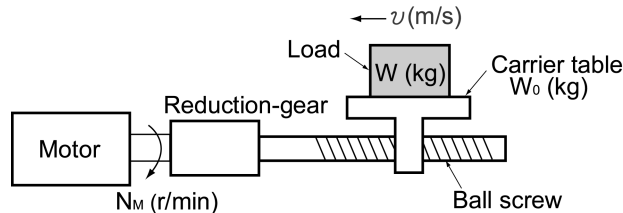

Figure 7.7 Moving a Load Horizontally

7.1.3.2 Acceleration and deceleration time calculation

When an object whose moment of inertia is J ($\text{kg}\cdot\text{m}^2$) rotates at the speed N (r/min), it has the following kinetic energy:

$$E = \frac{J}{2} \cdot \left(\frac{2\pi \cdot N}{60} \right)^2 \quad (\text{J}) \quad (7.5)$$

To accelerate the above rotational object, the kinetic energy will be increased; to decelerate the object, the kinetic energy must be discharged. The torque required for acceleration and deceleration can be expressed as follows:

$$\tau = J \cdot \frac{2\pi}{60} \left(\frac{dN}{dt} \right) \quad (\text{N}\cdot\text{m}) \quad (7.6)$$

This way, the mechanical moment of inertia is an important element in the acceleration and deceleration. First, calculation method of moment of inertia is described, then those for acceleration and deceleration time are explained.

[1] Calculation of moment of inertia

For an object that rotates around the rotation axis, virtually divide the object into small segments and square the distance from the rotation axis to each segment. Then, sum the squares of the distances and the masses of the segments to calculate the moment of inertia.

$$J = \sum (W_i \cdot r_i^2) \quad (\text{kg}\cdot\text{m}^2) \quad (7.7)$$

The following describes equations to calculate moment of inertia having different shaped loads or load systems.

(1) Hollow cylinder and solid cylinder

The common shape of a rotating body is hollow cylinder. The moment of inertia around the hollow cylinder center axis can be calculated as follows, where the outer and inner diameters are D_1 and D_2 [m] and total mass is W (kg) in Figure 7.8.

$$J = \frac{W \cdot (D_1^2 + D_2^2)}{8} \quad (\text{kg}\cdot\text{m}^2) \quad (7.8)$$

For a similar shape, a solid cylinder, calculate the moment of inertia as D_2 is 0.

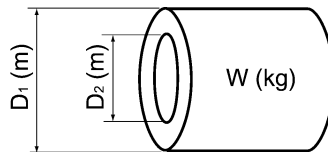
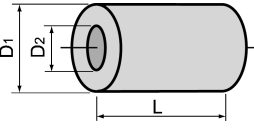
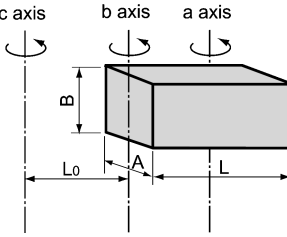
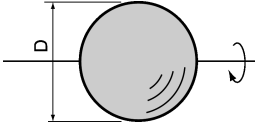
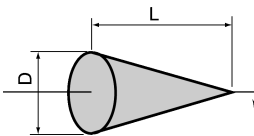
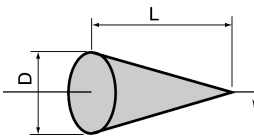
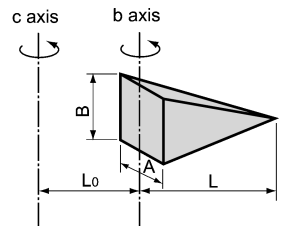
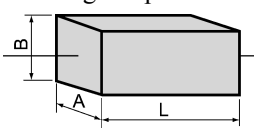
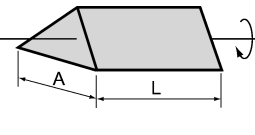
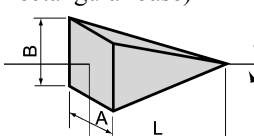
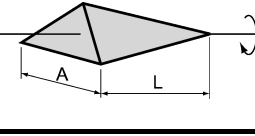
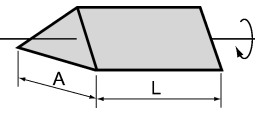
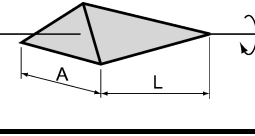
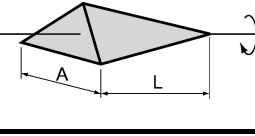

Figure 7.8 Hollow Cylinder

(2) For a general rotating body

Table 7.1 lists the calculation equations of moment of inertia of various rotating bodies including the above cylindrical rotating body.

Table 7.1 Moment of Inertia of Various Rotating Bodies

Shape	Mass: W (kg) Moment of inertia: J (kg·m ²)	Shape	Mass: W (kg) Moment of inertia: J (kg·m ²)
Hollow cylinder 	$W = \frac{\pi}{4} \cdot (D_1^2 - D_2^2) \cdot L \cdot \rho$ $J = \frac{1}{8} \cdot W \cdot (D_1^2 + D_2^2)$		$W = A \cdot B \cdot L \cdot \rho$ $J_a = \frac{1}{12} \cdot W \cdot (L^2 + A^2)$ $J_b = \frac{1}{12} \cdot W \cdot (L^2 + \frac{1}{4} \cdot A^2)$ $J_c \approx W \cdot (L_0^2 + L_0 \cdot L + \frac{1}{3} \cdot L^2)$
Sphere 	$W = \frac{\pi}{6} \cdot D^3 \cdot \rho$ $J = \frac{1}{10} \cdot W \cdot D^2$		$W = \frac{\pi}{4} \cdot D^2 \cdot L \cdot \rho$ $J_a = \frac{1}{12} \cdot W \cdot (L^2 + \frac{3}{4} \cdot D^2)$ $J_b = \frac{1}{3} \cdot W \cdot (L^2 + \frac{3}{16} \cdot D^2)$ $J_c \approx W \cdot (L_0^2 + L_0 \cdot L + \frac{1}{3} \cdot L^2)$
Cone 	$W = \frac{\pi}{12} \cdot D^2 \cdot L \cdot \rho$ $J = \frac{3}{40} \cdot W \cdot D^2$		$W = \frac{\pi}{3} \cdot A \cdot B \cdot L \cdot \rho$ $J_b = \frac{1}{10} \cdot W \cdot (L^2 + \frac{1}{4} \cdot A^2)$ $J_c \approx W \cdot (L_0^2 + \frac{3}{2} \cdot L_0 \cdot L + \frac{3}{5} \cdot L^2)$
Rectangular prism 	$W = A \cdot B \cdot L \cdot \rho$ $J = \frac{1}{12} \cdot W \cdot (A^2 + B^2)$		$W = \frac{\pi}{12} \cdot D^2 \cdot L \cdot \rho$ $J_b = \frac{1}{10} \cdot W \cdot (L^2 + \frac{3}{8} \cdot D^2)$ $J_c \approx W \cdot (L_0^2 + \frac{3}{2} \cdot L_0 \cdot L + \frac{3}{5} \cdot L^2)$
Square cone (Pyramid, rectangular base) 	$W = \frac{1}{3} \cdot A \cdot B \cdot L \cdot \rho$ $J = \frac{1}{20} \cdot W \cdot (A^2 + B^2)$		$W = \frac{\pi}{12} \cdot D^2 \cdot L \cdot \rho$ $J_b = \frac{1}{10} \cdot W \cdot (L^2 + \frac{3}{8} \cdot D^2)$ $J_c \approx W \cdot (L_0^2 + \frac{3}{2} \cdot L_0 \cdot L + \frac{3}{5} \cdot L^2)$
Triangular prism 	$W = \frac{\sqrt{3}}{4} \cdot A^2 \cdot L \cdot \rho$ $J = \frac{1}{3} \cdot W \cdot A^2$		$W = \frac{\pi}{12} \cdot D^2 \cdot L \cdot \rho$ $J_b = \frac{1}{10} \cdot W \cdot (L^2 + \frac{3}{8} \cdot D^2)$ $J_c \approx W \cdot (L_0^2 + \frac{3}{2} \cdot L_0 \cdot L + \frac{3}{5} \cdot L^2)$
Tetrahedron with an equilateral triangular base 	$W = \frac{\sqrt{3}}{12} \cdot A^2 \cdot L \cdot \rho$ $J = \frac{1}{5} \cdot W \cdot A^2$		

Main metal density (at 20°C) ρ(kg/m³) Iron: 7860, Copper: 8940, Aluminum: 2700

(3) For a load running horizontally

Assume a carrier table driven by a motor as shown in Figure 7.7. If the table speed is v (m/s) when the motor speed is N_M (r/min), then an equivalent distance from the rotation axis is equal to $60 \cdot v / (2\pi \cdot N_M)$ m. The moment of inertia of the table and load to the rotation axis is calculated as follows:

$$J = \left(\frac{60 \cdot v}{2\pi \cdot N_M} \right)^2 \cdot (W_0 + W) \quad (\text{kg} \cdot \text{m}^2) \quad (7.9)$$

[2] Calculation of the acceleration time

Figure 7.9 shows a general load model. Assume that a motor drives a load via a reduction-gear with efficiency η_G . The time required to accelerate this load to a speed of N_M (r/min) is calculated with the following equation:

$$t_{\text{ACC}} = \frac{J_1 + J_2/\eta_G}{\tau_M - \tau_L/\eta_G} \cdot \frac{2\pi \cdot (N_M - 0)}{60} \quad (\text{s}) \quad (7.10)$$

where,

J_1 : Motor shaft moment of inertia ($\text{kg} \cdot \text{m}^2$)

J_2 : Load shaft moment of inertia converted to motor shaft ($\text{kg} \cdot \text{m}^2$)

τ_M : Minimum motor output torque in driving mode ($\text{N} \cdot \text{m}$)

τ_L : Maximum load torque converted to motor shaft ($\text{N} \cdot \text{m}$)

η_G : Reduction-gear efficiency.

As clarified in the above equation, the equivalent moment of inertia becomes $(J_1 + J_2/\eta_G)$ by considering the reduction-gear efficiency.

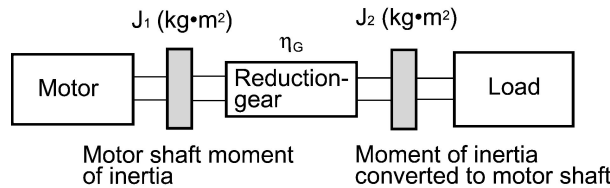

Figure 7.9 Load Model Including Reduction-gear

[3] Calculation of the deceleration time

In a load system shown in Figure 7.9, the time needed to stop the motor rotating at a speed of N_M (r/min) is calculated with the following equation:

$$t_{\text{DEC}} = \frac{J_1 + J_2 \cdot \eta_G}{\tau_M - \tau_L \cdot \eta_G} \cdot \frac{2\pi \cdot (0 - N_M)}{60} \quad (\text{s}) \quad (7.11)$$

where,

J_1 : Motor shaft moment of inertia ($\text{kg} \cdot \text{m}^2$)

J_2 : Load shaft moment of inertia converted to motor shaft ($\text{kg} \cdot \text{m}^2$)

τ_M : Minimum motor output torque in deceleration mode ($\text{N} \cdot \text{m}$)

τ_L : Maximum load torque converted to motor shaft ($\text{N} \cdot \text{m}$)

η_G : Reduction-gear efficiency

In the above equation, generally output torque τ_M is negative and load torque τ_L is positive. So, deceleration time becomes shorter.

7.1.3.3 Heat energy calculation of braking resistor

If the inverter brakes the motor, the kinetic energy of mechanical load is converted to electric energy to be transmitted into the inverter circuit. This regenerative energy is often consumed in so-called braking resistors as heat. The following explains the braking resistor rating.

[1] Calculation of regenerative energy

In the inverter operation, one of the regenerative energy sources is the kinetic energy that is generated at the time an object is moved by an inertial force.

Kinetic energy of a rotational object

When an object with moment of inertia J ($\text{kg}\cdot\text{m}^2$) rotates at a speed N_2 (r/min), its kinetic energy is as follows:

$$E = \frac{J}{2} \cdot \left(\frac{2\pi \cdot N_2}{60} \right)^2 \quad (\text{J}) \quad (7.12)$$

$$\approx \frac{1}{182.4} \cdot J \cdot N_2^2 \quad (\text{J}) \quad (7.12)'$$

When this object is decelerated to a speed N_1 (r/min), the output energy is as follows:

$$E = \frac{J}{2} \cdot \left[\left(\frac{2\pi \cdot N_2}{60} \right)^2 - \left(\frac{2\pi \cdot N_1}{60} \right)^2 \right] \quad (\text{J}) \quad (7.13)$$

$$\approx \frac{1}{182.4} \cdot J \cdot (N_2^2 - N_1^2) \quad (\text{J}) \quad (7.13)'$$

The energy regenerated to the inverter as shown in Figure 7.9 is calculated from the reduction-gear efficiency η_G and motor efficiency τ_M as follows:

$$E \approx \frac{1}{182.4} \cdot (J_1 + J_2 \cdot \eta_G) \cdot \eta_M \cdot (N_2^2 - N_1^2) \quad (\text{J}) \quad (7.14)$$

[2] Calculation of energy able to regenerate per inverter

Energy able to regenerate per inverter is determined by the power source voltage and capacitance of the DC link bus capacitor(s).

$$E_c = \frac{1}{2} \cdot C \cdot V^2 \quad (\text{J}) \quad (7.15)$$

If the value E obtained by the equation (7.14) does not exceed the value E_c obtained here, the inverter is able to decelerate its load.

Part 5 Specifications and Troubleshooting



Chapter 8 SPECIFICATIONS

Chapter 9 FUNCTION CODES

Chapter 10 TROUBLESHOOTING

Chapter 8

SPECIFICATIONS

This chapter describes specifications of the output ratings, control system, and terminal functions for the FRENIC-Eco series of inverters. It also provides descriptions of the operating and storage environment, external dimensions, examples of basic connection diagrams, and details of the protective functions.

Contents

8.1	Standard Models.....	8-1
8.2	Models Available on Order	8-3
8.2.1	EMC filter built-in type.....	8-3
8.2.2	Waterproof type.....	8-5
8.3	Common Specifications	8-7
8.4	Terminal Specifications.....	8-10
8.4.1	Terminal functions.....	8-10
8.4.2	Terminal arrangement diagram and screw specifications	8-29
8.4.2.1	Main circuit terminals	8-29
8.4.2.2	Control circuit terminals	8-31
8.5	Operating Environment and Storage Environment.....	8-32
8.5.1	Operating environment.....	8-32
8.5.2	Storage environment	8-33
8.5.2.1	Temporary storage.....	8-33
8.5.2.2	Long-term storage	8-33
8.6	External Dimensions	8-34
8.6.1	Standard models	8-34
8.6.2	DC reactor	8-37
8.6.3	Models available on order	8-38
8.6.3.1	EMC filter built-in type.....	8-38
8.6.3.2	Waterproof type (IP54).....	8-40
8.6.4	Standard keypad	8-42
8.7	Connection Diagrams.....	8-43
8.7.1	Running the inverter with keypad.....	8-43
8.7.2	Running the inverter by terminal commands	8-44
8.8	Protective Functions.....	8-46

8.1 Standard Models

Three-phase 400 V class series

■ 0.75 to 55 kW

Item		Specifications														
Type (FRN_ _ _ F1S-4E)		0.75	1.5	2.2	4.0	5.5	7.5	11	15	18.5	22	30	37	45	55	
Nominal applied motor (kW) *1		0.75	1.5	2.2	4.0	5.5	7.5	11	15	18.5	22	30	37	45	55	
Output ratings	Rated capacity (kVA) *2	1.9	2.8	4.1	6.8	9.5	12	17	22	28	33	44	54	64	80	
	Rated voltage (V) *3	Three-phase, 380, 400 V/50 Hz, 380, 400, 440, 460 V/60 Hz (with AVR function)														
	Rated current (A) *4	2.5	3.7	5.5	9.0	12.5	16.5	23	30	37	44	59	72	85	105	
	Overload capability	120% of rated current for 1 min														
	Rated frequency	50, 60 Hz														
Input ratings	Phases, voltage, frequency	Main power supply	Three-phase, 380 to 480 V, 50/60 Hz										Three-phase, 380 to 440 V/50 Hz Three-phase, 380 to 480 V/60 Hz			
		Auxiliary control power input	Single-phase, 380 to 480 V, 50/60 Hz										Single-phase, 380 to 440 V/50 Hz Single-phase, 380 to 480 V/60 Hz			
	Auxiliary fan power input *5	None													*9	
Voltage/frequency allowance		Voltage: +10 to -15% (Voltage unbalance: 2% or less)*10, Frequency: +5 to -5%														
Rated current (A) *6	(with DCR)	1.6	3.0	4.5	7.5	10.6	14.4	21.1	28.8	35.5	42.2	57.0	68.5	83.2	102	
	(without DCR)	3.1	5.9	8.2	13.0	17.3	23.2	33.0	43.8	52.3	60.6	77.9	94.3	114	140	
Required power supply capacity (kVA) *7		1.2	2.2	3.1	5.3	7.4	10	15	20	25	30	40	48	58	71	
Braking	Torque (%) *8	20										10 to 15				
	DC braking	Starting frequency: 0.0 to 60.0 Hz, Braking time: 0.0 to 30.0 s, Braking level: 0 to 60%														
DC reactor (DCR)		Option														
Applicable safety standards		UL508C, C22.2 No.14, EN50178:1997 (Applying)														
Enclosure (IEC60529)		IP20, UL open type										IP00, UL open type				
Cooling method		Natural cooling				Fan cooling										
Mass (kg)		3.1	3.2	3.3	3.4	3.4	5.8	6.0	6.9	9.4	9.9	11.5	23	24	33	

*1 Fuji 4-pole standard motor

*2 Rated capacity is calculated by assuming the output rated voltage as 440 V for three-phase 400 V class series.

*3 Output voltage cannot exceed the power supply voltage.

*4 An excessively low setting of the carrier frequency may result in high motor temperature or activation of inverter protective function (current limit processing). When setting the carrier frequency to 1 kHz or below, reduce the load to 80% of its rating.

*5 Use [R1, T1] terminals for driving AC cooling fans of an inverter powered by the DC link bus, such as by a high power factor PWM converter. (In ordinary operation, the terminals are not used.)

*6 The value is calculated assuming that the inverter is connected with a power supply with the capacity of 500 kVA (or 10 times the inverter capacity if the inverter capacity exceeds 50 kVA) and %X is 5%.

*7 Obtained when a DC reactor (DCR) is used.

*8 Average braking torque (Varies with the efficiency of the motor.)

*9 Single-phase, 380 to 440 V/50 Hz or Single-phase, 380 to 480 V/60 Hz

*10 Voltage unbalance (%) = $\frac{\text{Max. voltage (V)} - \text{Min. voltage (V)}}{\text{Three-phase average voltage (V)}} \times 67$ (IEC61800-3 (5.2.3))

If this value is 2 to 3%, use an AC reactor (ACR).

■ 75 to 560 kW

Item		Specifications														
Type (FRN__F1S-4E)		75	90	110	132	160	200	220	280	315	355	400	450	500	560	
Nominal applied motor (kW) *1		75	90	110	132	160	200	220	280	315	355	400	450	500	560	
Output ratings	Rated capacity (kVA) *2	105	128	154	182	221	274	316	396	445	495	563	640	731	792	
	Rated voltage (V) *3	Three-phase, 380, 400 V/50 Hz, 380, 400, 440, 460 V/60 Hz (with AVR function)														
	Rated current (A) *4	139	168	203	240	290	360	415	520	585	650	740	840	960	1040	
	Overload capability	120% of rated current for 1 min														
	Rated frequency	50, 60 Hz														
Input ratings	Phases, voltage, frequency	Main power supply	Three-phase, 380 to 440 V, 50 Hz or Three-phase, 380 to 480 V, 60 Hz													
		Auxiliary control power input	Single-phase, 380 to 480 V, 50/60 Hz													
		Auxiliary fan power input *5	Single-phase, 380 to 440 V/50 Hz Single-phase, 380 to 480 V/60 Hz													
	Voltage/frequency allowance		Voltage: +10 to -15% (Voltage unbalance: 2% or less)*9, Frequency: +5 to -5%													
	Rated current (A) *6	(with DCR)	138	164	201	238	286	357	390	500	559	628	705	789	881	990
(without DCR)		—	—	—	—	—	—	—	—	—	—	—	—	—	—	
Required power supply capacity (kVA) *7		96	114	140	165	199	248	271	347	388	435	489	547	611	686	
Braking	Torque (%) *8	10 to 15														
	DC braking	Starting frequency: 0.0 to 60.0 Hz, Braking time: 0.0 to 30.0 s, Braking level: 0 to 60%														
DC reactor (DCR)		Standard														
Applicable safety standards		UL508C, C22.2 No.14, EN50178:1997 (Applying)														
Enclosure (IEC60529)		IP00, UL open type														
Cooling method		Fan cooling														
Mass (kg)		34	42	45	63	67	96	98	162	165	282	286	355	360	360	

*1 Fuji 4-pole standard motor

*2 Rated capacity is calculated by assuming the output rated voltage as 440 V for three-phase 400 V class series.

*3 Output voltage cannot exceed the power supply voltage.

*4 An excessively low setting of the carrier frequency may result in high motor temperature or activation of inverter protective function (current limit processing). When setting the carrier frequency to 1 kHz or below, reduce the load to 80% of its rating.

*5 Use [R1, T1] terminals for driving AC cooling fans of an inverter powered by the DC link bus, such as by a high power factor PWM converter. (In ordinary operation, the terminals are not used.)

*6 The value is calculated assuming that the inverter is connected with a power supply with the capacity of 500 kVA (or 10 times the inverter capacity if the inverter capacity exceeds 50 kVA) and %X is 5%.

*7 Obtained when a DC reactor (DCR) is used.

*8 Average braking torque (Varies with the efficiency of the motor.)

*9 Voltage unbalance (%) = $\frac{\text{Max. voltage (V)} - \text{Min. voltage (V)}}{\text{Three-phase average voltage (V)}} \times 67$ (IEC61800-3 (5.2.3))

If this value is 2 to 3%, use an AC reactor (ACR).

8.2 Models Available on Order

8.2.1 EMC filter built-in type

Three-phase 200 V class series

Item		Specifications								
Type (FRN ___ F1E-2E)		0.75	1.5	2.2	3.7	5.5	7.5	11	15	
Applicable motor rating [kW]	*1	0.75	1.5	2.2	3.7	5.5	7.5	11	15	
Rated capacity [kVA]	*2	1.6	2.6	4.0	6.3	9.0	12	17	22	
Output ratings	Voltage [V]	*3 Three-phase 200 to 240 V (with AVR function)								
	Rated current [A]	*4 *8	4.2	7.0	10.6	16.7	23.8 (22.5)	31.8 (29)	45 (42)	58 (55)
	Overload capability	120% of rated current for 1 min								
	Rated frequency [Hz]	50, 60 Hz								
Input ratings	Phases, voltage, frequency	Main power supply	Three-phase, 200 to 240 V, 50/60 Hz							
		Auxiliary control power input	Single-phase, 200 to 240 V, 50/60 Hz							
	Voltage/frequency variations	Voltage: +10 to -15% (Voltage unbalance: 2% or less *7), Frequency: +5 to -5%								
	Rated input current [A]	*5	3.2	6.1	8.9	15.0	21.1	28.8	42.2	57.6
Required power supply capacity [kVA]		1.2	2.2	3.1	5.3	7.4	10	15	20	
Braking	Braking torque [%]	*6	20							
	DC injection braking	Starting frequency: 0.0 to 60.0 Hz, Braking time: 0.0 to 30.0 s, Braking level: 0 to 60%								
EMC filter unit	EMC filter	Provided (Compatible EMC standard: Emission, Immunity: 2nd Env. (EN61800-3: 1996+A11: 2000)								
	DC REACTOR	Provided (If load of 100% is used (rated output) used, power supply ratio is above 86%.)								
Applicable safety standards	UL508C, C22.2No.14, EN50178: 1997 (Approval pending)									
Enclosure (IEC60529)	IP20, UL type									
Cooling method	Natural cooling			Fan cooling						
Weight / Mass [kg]		6.0	6.3	6.7	6.8	7.0	13.9	14.6	15.4	

*1 Fuji's 4-pole standard motor

*2 Rated capacity is calculated by assuming the output rated voltage as 220 V.

*3 Output voltage cannot exceed the power supply voltage.

*4 An excessively low setting of the carrier frequency may result in high motor temperature or activation of inverter protective function (current limit processing). When setting the carrier frequency to 1 kHz or below, reduce the load to 80% of its rating.

*5 The value is calculated on assumption that the inverter is connected with a power supply capacity of 500 kVA (or 10 times the inverter capacity if the inverter capacity exceeds 50 kVA) and %X is 5%.

*6 Average braking torque without optional braking resistor (Varies with the efficiency of the motor.)

*7 Voltage unbalance [%] = $\frac{\text{Max. voltage [V]} - \text{Min. voltage [V]}}{\text{Three-phase average voltage [V]}} \times 67$ (compliant with IEC61800-3)

If this value is 2 to 3%, use an AC REACTOR (ACR option).

*8 Use the inverter at the current given in () or below when the carrier frequency setting is higher than 3 kHz or the ambient temperature is 40°C or higher.

Three-phase 400 V class series

Item		Specifications								
Type (FRN___F1E-4E)		0.75	1.5	2.2	3.7	5.5	7.5	11	15	
Applicable motor rating [kW]		*1	0.75	1.5	2.2	3.7	5.5	7.5	11	15
Output ratings	Rated capacity [kVA]	*2	1.9	2.8	4.1	6.8	9.5	12	17	22
	Voltage [V]	*3	Three-phase 200 to 240 V (with AVR function)							
	Rated current [A]	*4	2.5	3.7	5.5	9.0	12.5	16.5	23	30
	Overload capability		120% of rated current for 1 min							
	Rated frequency [Hz]		50, 60 Hz							
Input ratings	Phases, voltage, frequency	Main power supply	Three-phase, 380 to 480 V, 50/60 Hz							
		Auxiliary control power input	Single-phase, 380 to 480 V, 50/60 Hz							
	Voltage/frequency variations		Voltage: +10 to -15% (Voltage unbalance: 2% or less *7), Frequency: +5 to -5%							
	Rated input current [A]	*5	1.6	3.0	4.5	7.5	10.6	14.4	21.1	28.8
Required power supply capacity [kVA]		1.2	2.2	3.1	5.3	7.4	10	15	20	
Braking	Braking torque [%]	*6	20							
	DC injection braking		Starting frequency: 0.0 to 60.0 Hz, Braking time: 0.0 to 30.0 s, Braking level: 0 to 60%							
EMC filter unit	EMC filter		Provided (According to the compatible EMC standard, emission corresponds to class A (NE55011: 1998+A1: 1999+ A2: 2002) and immunity corresponds to 2nd ENV. (EN61800-3: 1996+A11: 2000).							
	DC REACTOR		Provided (Under 100% load of rated output, the power factor is 86% or over.)							
Applicable safety standards			UL508C, C22.2No.14, EN50178: 1997 (Approval pending)							
Enclosure (IEC60529)			IP20, UL type							
Cooling method			Natural cooling				Fan cooling			
Weight / Mass [kg]			6.0	6.3	6.5	6.9	6.9	14.8	14.5	15.2

*1 Fuji's 4-pole standard motor

*2 Rated capacity is calculated by assuming the output rated voltage as 440 V.

*3 Output voltage cannot exceed the power supply voltage.

*4 An excessively low setting of the carrier frequency may result in high motor temperature or activation of inverter protective function (current limit processing). When setting the carrier frequency to 1 kHz or below, reduce the load to 80% of its rating.

*5 The value is calculated on assumption that the inverter is connected with a power supply capacity of 500 kVA (or 10 times the inverter capacity if the inverter capacity exceeds 50 kVA) and %X is 5%.

*6 Average braking torque without optional braking resistor (Varies with the efficiency of the motor.)

*7 Voltage unbalance [%] = $\frac{\text{Max. voltage [V]} - \text{Min. voltage [V]}}{\text{Three-phase average voltage [V]}} \times 67$ (compliant with IEC61800-3)

If this value is 2 to 3%, use an AC REACTOR (ACR option).

8.2.2 Waterproof type

Three-phase 200 V class series

Item		Specifications												
Type (FRN _ _ _ F1□ -2E)		0.75	1.5	2.2	3.7	5.5	7.5	11	15	18.5	22	30	37	45
Applicable motor rating [kW] *1		0.75	1.5	2.2	3.7	5.5	7.5	11	15	18.5	22	30	37	45
Output ratings	Rated capacity [kVA] *2	1.6	2.6	4.0	6.3	9.0	12	17	22	27	32	43	53	64
	Voltage [V] *3	Three-phase 200 to 240 V (with AVR function)												
	Rated current [A] *4 *9	4.2	7.0	10.6	16.7	23.8 (22.5)	31.8 (29)	45 (42)	58 (55)	73 (68)	85 (80)	114 (107)	140 (130)	170 (156)
	Overload capability	120% of rated current for 1 min												
	Rated frequency [Hz]	50, 60 Hz												
Input ratings	Phases, voltage, frequency	Main power supply	Three-phase, 200 to 240 V, 50/60 Hz										Three-phase, 200 to 220V/50Hz Three-phase, 200 to 230V/60Hz	
		Auxiliary control power input	Single-phase, 200 to 240 V, 50/60 Hz										Single-phase, 200 to 220V/50Hz Single-phase, 200 to 230V/60Hz	
		Auxiliary fan power input *5	—											
	Voltage/frequency variations		Voltage: +10 to -15% (Voltage unbalance: 2% or less *8), Frequency: +5 to -5%											
Rated input current [A] *6		5.3	9.5	13.2	22.2	31.5	42.7	60.7	80.1	97.0	112	151	185	225
Required power supply capacity [kVA]		1.9	3.3	4.6	7.7	11	15	22	28	34	39	53	65	78
Braking	Braking torque [%] *7	20										10 to 15		
	DC injection braking	Starting frequency: 0.0 to 60.0 Hz, Braking time: 0.0 to 30.0 s, Braking level: 0 to 60%												
Applicable safety standards		UL508C, C22.2No.14, EN50178: 1997 (Approval pending)												
Enclosure		IP54 (IEC60529)/UL TYPE12 (UL50)												
Cooling method		Natural cooling						Fan cooling						
Weight / Mass [kg]		11	11	12	12	12	18	18	19	27	27	29	47	63

*1 Fuji's 4-pole standard motor
 *2 Rated capacity is calculated by assuming the output rated voltage as 220 V.
 *3 Output voltage cannot exceed the power supply voltage.
 *4 An excessively low setting of the carrier frequency may result in high motor temperature or activation of inverter protective function (current limit processing). When setting the carrier frequency to 1 kHz or below, reduce the load to 80% of its rating.
 *5 It is used as an AC fan power supply input for applications combined with a high power-factor PWM converter with power regeneration function or the like (not used during normal operation).
 *6 The value is calculated on assumption that the inverter is connected with a power supply capacity of 500 kVA (or 10 times the inverter capacity if the inverter capacity exceeds 50 kVA) and %X is 5%.
 *7 Average braking torque without optional braking resistor (Varies with the efficiency of the motor.)
 *8 Voltage unbalance [%] = $\frac{\text{Max. voltage [V]} - \text{Min. voltage [V]}}{\text{Three-phase average voltage[V]}} \times 67$ (compliant with IEC61800-3)
 If this value is 2 to 3%, use an AC REACTOR (ACR option).
 *9 Use the inverter at the current given in () or below when the carrier frequency setting is higher than 3 kHz or the ambient temperature is 30°C or higher.

NOTE: A box (□) in the above table replaces B or D/L.

Three-phase 400 V class series

Item		Specifications																
Type (FRN__F1□-4E)		0.75	1.5	2.2	3.7	5.5	7.5	11	15	18.5	22	30	37	45	55	75	90	
Applicable motor rating [kW]	*1	0.75	1.5	2.2	3.7	5.5	7.5	11	15	18.5	22	30	37	45	55	75	90	
Output ratings	Rated capacity [kVA]	*2	1.9	2.8	4.1	6.8	9.5	12	17	22	28	33	44	54	64	80	105	128
	Voltage [V]	*3	Three-phase 380 to 480 V (with AVR function)															
	Rated current [A]	*4	2.5	3.7	5.5	9.0	12.5	16.5	23	30	37	44	59	72	85	105	139	168
	Overload capability		120% of rated current for 1 min															
	Rated frequency [Hz]		50, 60 Hz															
Input ratings	Phases, voltage, frequency	Main power supply	Three-phase, 380 to 480 V, 50/60 Hz										Three-phase, 380 to 440 V/50 Hz Three-phase, 380 to 480 V/60 Hz					
		Auxiliary control power input	Single-phase, 380 to 480 V, 50/60 Hz										Single-phase, 380 to 440 V/50 Hz Single-phase, 380 to 480 V/60 Hz					
		Auxiliary fan power input *5											Single-phase, 380 to 440 V/50 Hz Single-phase, 380 to 480 V/60 Hz					
	Voltage/frequency variations		Voltage: +10 to -15% (Voltage unbalance: 2% or less *8), Frequency: +5 to -5%															
	Rated input current [A]	Built-in DCR	*6	—	—	—	—	—	—	—	—	—	—	—	—	—	—	138
Without DCR			3.1	5.9	8.2	13.0	17.3	23.2	33.0	43.8	52.3	60.6	77.9	94.3	114	140	—	—
Required power supply capacity [kVA]		2.2	4.1	5.7	9.1	12	17	23	31	37	42	54	66	79	97	96	114	
Braking	Braking torque [%]	*7	20										10 to 15					
	DC injection braking		Starting frequency: 0.0 to 60.0 Hz, Braking time: 0.0 to 30.0 s, Braking level: 0 to 60%															
Applicable safety standards		UL508C, C22.2No.14, EN50178: 1997 (Approval pending)																
Enclosure		IP54 (IEC60529)/UL TYPE12 (UL50)																
Cooling method		Natural cooling				Fan cooling												
Weight / Mass [kg]		11	11	12	12	12	18	18	19	27	27	29	47	47	63	75	87	

*1 Fuji's 4-pole standard motor

*2 Rated capacity is calculated by assuming the output rated voltage as 440 V.

*3 Output voltage cannot exceed the power supply voltage.

*4 An excessively low setting of the carrier frequency may result in high motor temperature or activation of inverter protective function (current limit processing). When setting the carrier frequency to 1 kHz or below, reduce the load to 80% of its rating.

*5 It is used as an AC fan power supply input for applications combined with a high power-factor PWM converter with power regeneration function or the like (not used during normal operation).

*6 The value is calculated on assumption that the inverter is connected with a power supply capacity of 500 kVA (or 10 times the inverter capacity if the inverter capacity exceeds 50 kVA) and %X is 5%.









*7 Average braking torque without optional braking resistor (Varies with the efficiency of the motor.)

*8 Voltage unbalance [%] = $\frac{\text{Max. voltage [V]} - \text{Min. voltage [V]}}{\text{Three-phase average voltage[V]}} \times 67$ (compliant with IEC61800-3)

If this value is 2 to 3%, use an AC REACTOR (ACR option).

NOTE: A box (□) in the above table replaces B or D/L.

8.3 Common Specifications

	Item	Explanation	Remarks	Related function codes		
Output frequency	Setting range					
	Maximum frequency	25 to 120 Hz		F03		
	Base frequency	25 to 120 Hz		F04		
	Starting frequency	0.1 to 60.0 Hz		F23		
	Carrier frequency	<ul style="list-style-type: none"> • 0.75 to 15 kHz (200 V/400 V: 0.75 to 22 kW) • 0.75 to 10 kHz (200 V/400 V: 30 to 75 kW) • 0.75 to 6 kHz (200 V/400 V: 90 to 560 kW) • 0.75 to 4 kHz (200 V/400 V: 37 to 90 kW, IP54 series) 	The carrier frequency may drop automatically according to the ambient temperature or output current to protect the inverter. This protective operation can be canceled by function code H98.	F26 F27 H98		
	Accuracy (Stability)	<ul style="list-style-type: none"> • Analog setting: $\pm 0.2\%$ of maximum frequency (at $25 \pm 10^\circ\text{C}$) • Keypad setting: $\pm 0.01\%$ of maximum frequency (at -10 to $+50^\circ\text{C}$) 				
	Setting resolution	<ul style="list-style-type: none"> • Analog setting: 1/1000 of maximum frequency (ex. 0.06 Hz at 60 Hz, 0.12 Hz at 120 Hz) • Keypad setting: 0.01 Hz (99.99 Hz or less), 0.1 Hz (100.0 Hz or more) • Link setting: Selectable from 2 types- <ul style="list-style-type: none"> • 1/20000 of maximum frequency (ex. 0.003 Hz at 60 Hz, 0.006 Hz at 120 Hz) • 0.01 Hz (fixed) 	Setting with  /  keys.			
Control	Control method	V/f control				
	Voltage/freq. characteristic (Non-linear V/f setting)	Possible to set output voltage at base frequency and at maximum output frequency (common spec.). AVR control can be turned ON or OFF. ----- 1 point (Arbitrary voltage and frequency can be set.)	Three-phase 200 V: 80 to 240 V Three-phase 400 V: 160 to 500 V ----- Three-phase 200 V: 0 to 240 V/0 to 120 Hz Three-phase 400 V: 0 to 500 V/0 to 120 Hz	F03 to F05 H50, H51		
	Torque boost (Load selection)	Torque boost can be set with the function code F09. ----- Select application load type with the function code F37. 0: Variable torque load 1: Variable torque load (for high starting torque) 2: Auto-torque boost 3: Auto-energy-saving operation (variable torque load in acceleration/deceleration) 4: Auto-energy-saving operation (variable torque load (for high starting torque) for acceleration/deceleration) 5: Auto-energy-saving operation (auto-torque boost in acceleration/deceleration)	Set when 0, 1, 3, or 4 is selected at F37.	F09, F37 F09, F37		
	Starting torque	50% or over				
	Start/stop	Keypad operation	Start (FWD/REV) and stop with  /  keys	Keypad (standard)	F02	
			Start and stop with  /  /  keys	Multifunction keypad (option)	F02	
		External signals (7 digital inputs): Forward (reverse) rotation, stop command (capable of 3-wire operation), second operation command, coast-to-stop command, external alarm, alarm reset, etc.				E01 to E05 E98, E99
		Link operation: Operation through RS-485 communication and Field Bus communication (option)				H30, y98
	Operation command switch: Remote/local switch, link switch, second operation command switch					
	Frequency command source	Keypad operation: Can be set with  /  keys.			F01, C30	
External potentiometer (1 to 5 k Ω , 1/2 W): Prepared by users		Connected to analog input terminals [13], [12], [11].				
Analog input		Can be set with external voltage/current input. 0 to 10 VDC (0 to +5 VDC) / 0 to 100% (terminal [12], [V2]) 4 to 20 mA DC/0 to 100% (terminal [C1])	E.g.: 0 to 5 VDC/1 to 5 VDC is applicable with bias/ gain for analog input.	F18, C50, C32 to C34, C37 to C39, C42 to C44		
Multistep frequency: Selectable from 8 steps (step 0 to 7)			C05 to C11			
UP/DOWN operation: The frequency rises or lowers while the digital input signal is turned on.			F01, C30			
Link operation: Can be set with RS-485 communications and field bus communications (option).			H30, y98			
Frequency setting change: Two types of frequency settings can be switched with an external signal (digital input). Changeover between remote and local (keypad operation) or frequency setup through communication is also possible.			F01, C30			
Auxiliary frequency setting: Inputs at terminal [12], [C1] or [V2] can be added to the main setting as auxiliary frequency settings.			E61 to E63			
Inverse operation: The digital input signal and function code setting sets or switches between the normal and inverse operations. • 10 to 0 VDC/0 to 100% (Terminal [12], [V2]) • 20 to 4 mA DC/0 to 100% (Terminal [C1])			C53			
Acceleration/ deceleration time		0.00 to 3600 s • Acceleration and deceleration pattern can be selected from 4 types: Linear, S-curve (weak), S-curve (strong), Curve (constant output max. capacity). • Shutoff of the operation command coasts the motor to decelerate and stop.		F07, F08 H07 H11		

	Item	Explanation	Remarks	Related function codes
Control	Frequency limiter	High and low limiters can be set (setting range: 0 to 120 Hz)	Selection can be made between continuation of operation and stopping at frequencies equal to or smaller than the lower limit.	F15, F16 H63
	Bias frequency	Bias of frequency and PID commands can be set in the range between 0 and ±100%.		F18, C50 to C52
	Gain for frequency setting	The analog input gain can be set in the range from 0 to 200%.	Voltage signals (terminal [12], [V2]) and current signal (terminal [C1]) can be set independently.	C32, C34, C37 C39, C42, C44
	Jump frequency setting	3 operation points and their common jump hysteresis width (0 to 30 Hz) can be set.		C01 to C04
	Restart after momentary power failure	<ul style="list-style-type: none"> The inverter restarts upon recovery from power failure without stopping the motor. In the "operation continuation mode," recovery of the power supply is waited for while the output frequency slightly drops. Selection can be made among starting at 0 Hz, starting at the frequency immediately before the momentary power failure, and starting at the frequency specified in the starting mode after power recovery. 		F14 H13 to H16, H92, H93
	Current limit	Keeps the current under the preset value during operation.		F43, F44
	Line/inverter switching	<ul style="list-style-type: none"> Line/inverter switching (starting at line frequency) can be made with a digital input signal (SW50, SW60). A built-in line/inverter switching sequence performs sequence control with a digital input signal (ISW50, ISW60) to output a signal (SW88, SW52-1, SW52-2) for controlling an external magnetic contactor (MC). As a built-in sequence, two types can be selected, including the one switching automatically to the line upon an inverter alarm. 		J22
	PID control	<p>Capable of PID regulator control for process</p> <p>Process commands</p> <ul style="list-style-type: none"> Key operation (UP and DOWN keys): 0 to 100% Analog input (terminal [12], [V2]): 0 to 10 VDC/0 to 100% Analog input (terminal [C1]): 4 to 20 mA DC/0 to 100% UP/DOWN (digital input): 0 to 100% Communication (RS-485, Bus option): 0 to 20,000/0 to 100% <p>Feedback value</p> <ul style="list-style-type: none"> Analog input (terminal [12], [V2]): 0 to 10 VDC/0 to 100% Analog input (terminal [C1]): 4 to 20 mA DC/0 to 100% <p>Accessory functions</p> <ul style="list-style-type: none"> Alarm output (absolute value alarm, deviation alarm) • Normal operation/inverse operation Sleep function • Anti reset windup function PID output limiter • Integration reset/hold 		E61 to E63 J01 to J06 J10 to J13 J15 to J19
	Auto search for idling motor's speed	Starting at the preset frequency, the inverter automatically searches for the idling motor's speed to be harmonized and starts to drive it without stopping it.		H09, H17
	Automatic deceleration	Upon a DC link bus voltage exceeding the overvoltage limit level during deceleration, the deceleration time automatically extends to avoid an \overline{UV} trip.		H69
	Deceleration characteristic	The motor loss increases during deceleration to reduce the load energy regenerating at the inverter to avoid an \overline{UV} trip upon mode selection.		H71
	Automatic energy-saving operation	The output voltage is controlled to minimize the total sum of the motor loss and inverter loss at a constant speed.		F37
	Overload prevention control	The output frequency is automatically reduced to suppress the overload protection trip of the inverter caused by an increase in the ambient temperature or motor load, or by other operating conditions.		H70
	Auto-tuning	The motor parameters are automatically tuned.		P04
Cooling fan ON/OFF control	Detects inverter internal temperature and stops cooling fan when the temperature is low.	An external output can be issued in a transistor or relay output signal.	H06	
Pump control	<p>An inverter controls multiple driving pumps at a time combining with driving sources of the inverter and commercial power. The inverter's integrated PID controller controls them in the flowrate, pressure and so on. The inverter controls each member of pump control sequences issuing the power source switching signal between the inverter output and commercial power. Two control modes are available. One is a fixed motor-driving mode where the inverter exclusively controls the single pump. Another is a floating motor-driving mode where the inverter cyclically controls a member of pumps.</p> <ul style="list-style-type: none"> Fixed motor-driving mode: Pumps under control = one inverter driven + four commercial power driven Floating motor-driving mode: Pumps under control = three inverter/commercial power driven (In this mode, a relay output card option (OPC-F1S-RY) is required.) <p>Furthermore, this control features a constantly periodic switching function, an average time drive-switching function, a cumulative pump run time monitor, a cumulative relay activating times monitor and so on.</p>		E01 to E05 E20 to E22 E24, E27 E61 to E63 J01 to J06 J10 to J13 J15 to J19 J25 to J43 J45 to J55	
Indication	Running/stopping	<ul style="list-style-type: none"> Speed monitor, output current (A), output voltage (V), torque calculation value, input power (kW), PID reference value, PID feedback value, PID output, load factor, motor output Select the speed monitor to be displayed from the following. Output frequency (Hz), motor speed (r/min), load shaft speed (r/min), % indication 	An external output can be issued in a transistor or relay output signal.	E43 E48
	Lifetime early warning	Shows the lifetime early warnings of the electrolytic capacitors on the printed circuit boards, the DC link bus capacitor, and the cooling fan.		
	Cumulative run time	Shows the cumulative running hours of the motor and inverter, and the input watt-hour.		

Item	Explanation	Remarks	Related function codes		
Indication	Trip error code Displays the cause of trip by codes. • <i>OC 1</i> (Overcurrent during acceleration) • <i>OC 2</i> (Overcurrent during deceleration) • <i>OC 3</i> (Overcurrent during running at constant speed) • <i>EF</i> (Grounding fault) • <i>LI 1</i> (Input phase loss) • <i>LU</i> (Undervoltage) • <i>OP 1</i> (Output phase loss) • <i>OU 1</i> (Overvoltage during acceleration) • <i>OU 2</i> (Overvoltage during deceleration) • <i>OU 3</i> (Overvoltage during running at constant speed) • <i>OH 1</i> (Overheating of the heat sink) • <i>OH 2</i> (External alarm) • <i>OH 3</i> (Inverter overheat) • <i>OH 4</i> (Motor protection (PTC thermistor)) • <i>OL 1</i> (Motor overload) • <i>OLU</i> (Inverter overload) • <i>FUS</i> (Blown fuse) • <i>PbF</i> (Charging circuit fault) • <i>Er 1</i> (Memory error) • <i>Er 2</i> (Keypad communication error) • <i>Er 3</i> (CPU error) • <i>Er 4</i> (Optional communication error) • <i>Er 5</i> (Option error) • <i>Er 6</i> (Operation action error) • <i>Er 7</i> (Tuning error) • <i>Er 8</i> (RS-485 communication error) • <i>Er F</i> (Data save error due to undervoltage) • <i>Er P</i> (RS-485 communication error (option)) • <i>Er H</i> (LSI error)				
	Trip history	Saves and displays the last 4 trip error codes and their detailed description.			
Protection	Overcurrent protection	The inverter is stopped upon an overcurrent caused by an overload.			
	Short circuit protection	The inverter is stopped upon an overcurrent caused by a short circuit in the output circuit.			
	Grounding fault protection	The inverter is stopped upon an overcurrent caused by a grounding fault in the output circuit.			
	Overvoltage protection	An excessive DC link bus voltage is detected to stop the inverter.	3-phase 200 V / 400 VDC 3-phase 400 V / 800 VDC		
	Surge protection	The inverter is protected against surge voltages intruding across the main circuit power cable and ground.			
	Undervoltage	Stops the inverter by detecting voltage drop in DC link bus.	3-phase 200 V / 200 VDC 3-phase 400 V / 400 VDC	F14	
	Input phase loss	Stops or protects the inverter against input phase loss.	The protective function can be canceled with function code H98.	H98	
	Output phase loss	Detects breaks in inverter output wiring at the start of running and during running, stopping the inverter output.	The protective function can be canceled with function code H98.	H98	
	Overheating	The temperature of the heat sink of the inverter or that inside the inverter unit is detected to stop the inverter, upon a failure or overload of the cooling fan.			
	Overload	The inverter is stopped upon the temperature of the heat sink of the inverter or the temperature of the switching element calculated from the output current.			
	Motor protection	Electronic thermal	The inverter is stopped upon an electronic thermal function setting to protect the motor.	Thermal time constant can be adjusted (0.5 to 75.0 min.).	F10 to F12, P99
		PTC thermistor	A PTC thermistor input stops the inverter to protect the motor.		H26, H27
		Overload early warning	Warning signal can be output based on the set level before the inverter trips.		F10, F12, E34, E35, P99
	Stall prevention	The output frequency decreases upon an output current exceeding the limit during acceleration or constant speed operation, to avoid overcurrent trip.		H12	
	Momentary power failure protection	• A protective function (inverter stoppage) is activated upon a momentary power failure for 15 msec or longer. • If restart upon momentary power failure is selected, the inverter restarts upon recovery of the voltage within the set time.		F14	
Retry function	When the inverter is tripped and stopped, this function automatically resets the tripping state and restarts operation.	Waiting time before resetting and the number of retry times can be set.	H04, H05		
Command loss detection	A loss (broken wire, etc.) of the frequency command is detected to output an alarm and continue operation at the preset frequency (set at a ratio to the frequency before detection).		E65		

8.4 Terminal Specifications

8.4.1 Terminal functions

Main circuit and analog input terminals

Classification	Symbol	Name	Functions	Related function codes
Main circuit	L1/R, L2/S, L3/T	Main circuit power inputs	Connect the three-phase input power lines.	
	U, V, W	Inverter outputs	Connect a three-phase motor.	
	R0, T0	Auxiliary power input for the control circuit	For a backup of the control circuit power supply, connect AC power lines same as that of the main power input.	
	P1, P(+)	DC reactor connection	Connect a DC reactor (DCR) for improving power factor (an option for the inverter whose capacity is 55 kW or below).	
	P(+), N(-)	DC link bus	Connect a DC link bus of other inverter(s). An optional regenerative converter is also connectable to these terminals.	
	R1, T1	Auxiliary power input for the fans	Normally, no need to use these terminals. Use these terminals for an auxiliary power input of the fans in a power system using a power regenerative PWM converter (RHC series).	
	 G	Grounding for inverter and motor	Grounding terminals for the inverter's chassis (or case) and motor. Earth one of the terminals and connect the grounding terminal of the motor. Inverters provide a pair of grounding terminals that function equivalently.	
Analog input	[13]	Potentiometer power supply	Power supply (+10 VDC) for frequency command potentiometer (Potentiometer: 1 to 5 kΩ) Maximum allowable output current: 10 mA	
	[12]	Voltage input	The frequency is commanded according to the external analog input voltage.	F01, F18, C30, C32-C34, E61
		(Normal operation)	0 to +10 VDC/0 to 100 %	
		(Inverse operation)	0 to +5 VDC/0 to 100 % or +1 to +5 VDC/0 to 100 % can be selected by function code setting. +10 to 0 VDC/0 to 100 % (switchable by digital input signal)	E01-E05, E98, E99
		(PID control)	Used for PID process command signal or its feedback.	
		(Auxiliary frequency command source)	Used as additional auxiliary setting to various frequency command sources.	
		(Analog input monitor)	The peripheral analog signal can be displayed on the keypad. (Displaying coefficient: valid)	
Electric characteristics of terminal [12]				
<ul style="list-style-type: none"> • Input impedance: 22 kΩ • Maximum allowable input voltage: +15 VDC (If the input voltage is +10 VDC or over, the inverter assumes it to be +10 VDC.) 				

Classification	Symbol	Name	Functions	Related function codes
Analog input	[C1]	Current input	The frequency is commanded according to the external analog input current.	F01, F18, C30, C37-C39, E62, E01-E05, E98, E99
		(Normal operation)	4 to 20 mA DC/0 to 100%	
		(Inverse operation)	20 to 4 mA DC/0 to 100 % (switchable by digital input signal)	
		(PID control)	Used for PID process command signal or its feedback.	
		(Auxiliary frequency command)	Used as additional auxiliary setting to various frequency commands.	
		(Analog input monitor)	The peripheral analog signal can be displayed on the keypad. (Displaying coefficient: valid)	
Electric characteristics of terminal [C1]			Figure 8.1 A-D conversion	
<ul style="list-style-type: none"> • Input impedance: 250 Ω • Maximum allowable input current: +30 mA DC (If the input current exceeds +20 mA DC, the inverter will limit it at +20 mA DC.) 				
Analog input	[V2]	Voltage input	The frequency is commanded according to the external analog input voltage.	F01, F18, C30, C42-C44, E63 E01-E05, E98, E99
		(Normal operation)	0 to +10 VDC/0 to 100 % 0 to +5 VDC/0 to 100 % or +1 to +5 VDC/0 to 100 % can be selected by function code setting.	
		(Inverse operation)	+10 to 0 VDC/0 to 100 % (switched by the terminal command (IVS))	
		(PID control)	Used for PID process command signal or its feedback.	

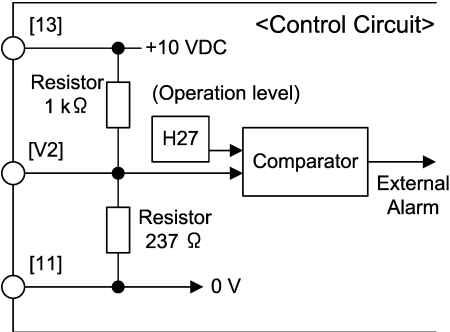
Classification	Symbol	Name	Functions	Related function codes
Analog input	[V2]	(For PTC thermistor)	<p>Connects PTC (Positive Temperature Coefficient) thermistor for motor protection. Ensure that the slide switch SW5 on the control printed circuit board (control PCB) is turned to the PTC position (refer to "<u>Setting up the slide switches</u>" on page 8-25).</p> <p>The figure shown below illustrates the internal circuit diagram where SW5 (switching the input of terminal [V2] between V2 and PTC) is turned to the PTC position. For details on SW5, refer to "<u>Setting up the slide switches</u>" on page 8-25. In this case, you must change data of the function code H26.</p>  <p>Figure 8.2 Internal Circuit Diagram (SW5 Selecting PTC)</p>	
		(Auxiliary frequency command)	Used as additional auxiliary setting to various frequency commands.	
		(Analog input monitor)	The peripheral analog signal can be displayed on the keypad. (Displaying coefficient: valid)	
			<p>Electric characteristics of terminal [V2]</p> <ul style="list-style-type: none"> • Input impedance: 22 kΩ • Maximum allowable input voltage: +15 VDC (If the input voltage is +10 VDC or over, the inverter assumes it to be +10 VDC.) 	
	[11]	Analog common	<p>Common for analog input signals ([13], [12], [C1], [V2], and [FMA])</p> <p>(Isolated from terminals [CM] and [CMY].)</p>	

Classification	Symbol	Name	Functions	Related function codes
Analog input	<p>Note</p> <ul style="list-style-type: none"> - Since low level analog signals are handled, these signals are especially susceptible to the external noise effects. Route the wiring as short as possible (within 20 m) and use shielded wires. In principle, ground the shielded sheath of wires; if effects of external inductive noises are considerable, connection to terminal [11] may be effective. As shown in Figure 8.3, ground the single end of the shield to enhance the shielding effect. - Use a twin contact relay for low level signals if the relay is used in the control circuit. Do not connect the relay's contact to terminal [11]. - When the inverter is connected to an external device outputting the analog signal, a malfunction may be caused by electric noise generated by the inverter. If this happens, according to the circumstances, connect a ferrite core (a toroidal core or an equivalent) to the device outputting the analog signal and/or connect a capacitor having the good cut-off characteristics for high frequency between control signal wires as shown in Figure 8.4. - Do not apply a voltage of +7.5 VDC or higher to terminal [C1]. Doing so could damage the internal control circuit. 			
	<p>Figure 8.3 Connection of Shielded Wire</p>	<p>Figure 8.4 Example of Electric Noise Reduction</p>		

Digital Input Terminals

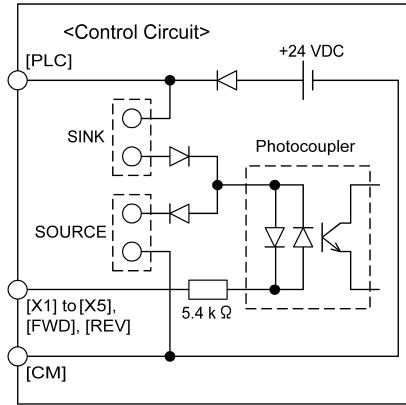
Classification	Symbol	Name	Functions	Related function codes																										
Digital input	[X1]	Digital input 1	<p>(1) The various signals such as coast-to-stop, alarm from external equipment, and multistep frequency commands can be assigned to terminals [X1] to [X5], [FWD] and [REV] by setting function codes E01 to E05, E98, and E99. For details, refer to Chapter 9, Section 9.2 "Overview of Function Codes."</p> <p>(2) Input mode, i.e. Sink/Source, is changeable by using the internal slide switch. (Refer to "<u>Setting up the slide switches</u>" on page 8-25.)</p> <p>(3) Switches the logic value (1/0) for ON/OFF of the terminals between [X1] to [X5], [FWD] or [REV], and [CM]. If the logic value for ON between [X1] and [CM] is 1 in the normal logic system, for example, OFF is 1 in the negative logic system and vice versa.</p> <p>(4) The negative logic system never applies to the terminals assigned for (FWD) and (REV).</p> <p>(Digital input circuit specifications)</p>  <p>Figure 8.5 Digital Input Circuit</p> <table border="1" data-bbox="686 1355 1244 1713"> <thead> <tr> <th colspan="2">Item</th> <th>Min.</th> <th>Max.</th> </tr> </thead> <tbody> <tr> <td rowspan="2">Operation voltage (SINK)</td> <td>ON level</td> <td>0 V</td> <td>2 V</td> </tr> <tr> <td>OFF level</td> <td>22 V</td> <td>27 V</td> </tr> <tr> <td rowspan="2">Operation voltage (SOURCE)</td> <td>ON level</td> <td>22 V</td> <td>27 V</td> </tr> <tr> <td>OFF level</td> <td>0 V</td> <td>2 V</td> </tr> <tr> <td colspan="2">Operation current at ON (Input voltage is at 0V)</td> <td>2.5 mA</td> <td>5 mA</td> </tr> <tr> <td colspan="2">Allowable leakage current at OFF</td> <td>-</td> <td>0.5 mA</td> </tr> </tbody> </table>	Item		Min.	Max.	Operation voltage (SINK)	ON level	0 V	2 V	OFF level	22 V	27 V	Operation voltage (SOURCE)	ON level	22 V	27 V	OFF level	0 V	2 V	Operation current at ON (Input voltage is at 0V)		2.5 mA	5 mA	Allowable leakage current at OFF		-	0.5 mA	E01
	Item			Min.	Max.																									
	Operation voltage (SINK)	ON level		0 V	2 V																									
		OFF level		22 V	27 V																									
	Operation voltage (SOURCE)	ON level		22 V	27 V																									
		OFF level		0 V	2 V																									
	Operation current at ON (Input voltage is at 0V)			2.5 mA	5 mA																									
Allowable leakage current at OFF		-	0.5 mA																											
	[X2]	Digital input 2	E02																											
	[X3]	Digital input 3	E03																											
	[X4]	Digital input 4	E04																											
	[X5]	Digital input 5	E05																											
	[FWD]	Run forward command	E98																											
	[REV]	Run reverse command	E99																											
	[PLC]	PLC signal power	Connects to PLC output signal power supply. (Rated voltage: +24 VDC; Allowable range: +22 to +27 VDC) This terminal also supplies a power to the circuitry connected to the transistor output terminals [Y1] to [Y3]. Refer to " <u>Analog output, pulse output, transistor output, and relay output terminals</u> " in this Section for more.																											
	[CM]	Digital common	Two common terminals for digital input signal terminals and output terminal [FMP] These terminals are electrically isolated from the terminals [11]s and [CMY].																											

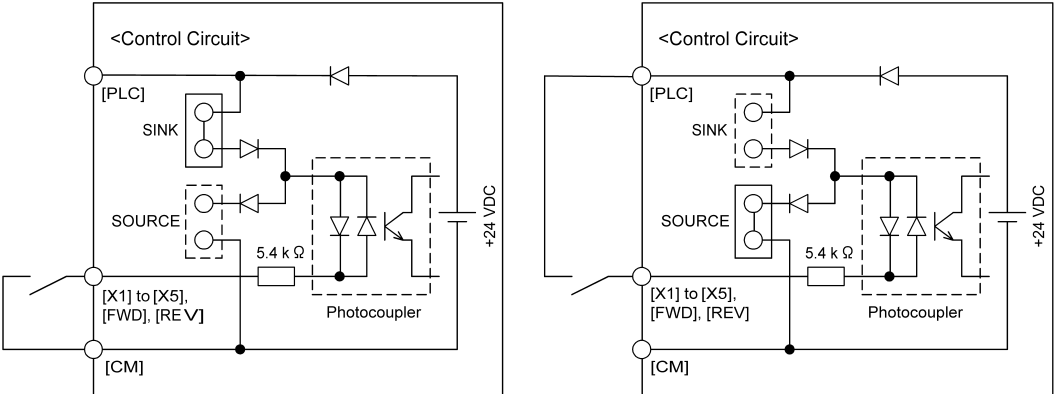
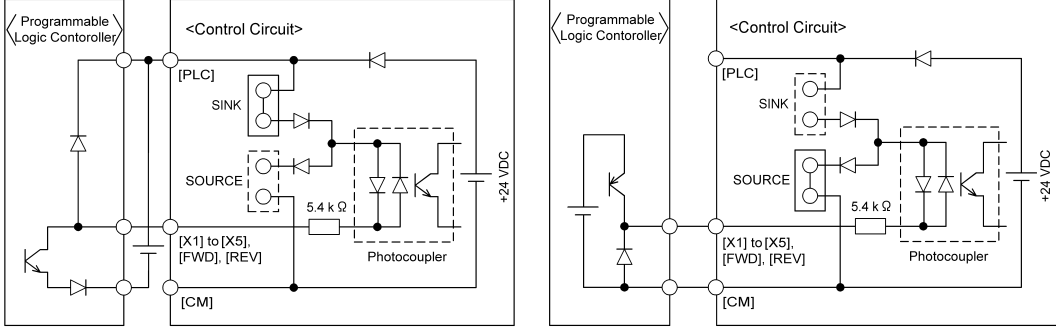
Classification	Symbol	Name	Functions	Related function codes
Digital input	<p>Tip</p> <p>■ Using a relay contact to turn [X1], [X2], [X3], [X4], [X5], [FWD], or [REV] ON or OFF</p> <p>Figure 8.6 shows two examples of a circuit that uses a relay contact to turn control signal input [X1], [X2], [X3], [X4], [X5], [FWD], or [REV] ON or OFF. In circuit (a), the slide switch SW1 has been turned to SINK, whereas in circuit (b) it has been turned to SOURCE.</p> <p>Note: To configure this kind of circuit, use a highly reliable relay (Recommended product: Fuji control relay Model HH54PW.)</p>			
	 <p>(a) With the switch turned to SINK</p> <p>(b) With the switch turned to SOURCE</p>	<p>Figure 8.6 Circuit Configuration Using a Relay Contact</p> <p>■ Using a programmable logic controller (PLC) to turn [X1], [X2], [X3], [X4], [X5], [FWD], or [REV] ON or OFF</p> <p>Figure 8.7 shows two examples of a circuit that uses a programmable logic controller (PLC) to turn control signal input [X1], [X2], [X3], [X4], [X5], [FWD], or [REV] ON or OFF. In circuit (a), the switch SW1 has been turned to SINK, whereas in circuit (b) it has been turned to SOURCE.</p> <p>In circuit (a) below, short-circuiting or opening the transistor's open collector circuit in the PLC using an external power source turns ON or OFF control signal [X1], [X2], [X3], [FWD], or [REV]. When using this type of circuit, observe the following:</p> <ul style="list-style-type: none"> - Connect the + node of the external power source (which should be isolated from the PLC's power) to terminal [PLC] of the inverter. - Do not connect terminal [CM] of the inverter to the common terminal of the PLC. 	 <p>(a) With the switch turned to SINK</p> <p>(b) With the switch turned to SOURCE</p>	<p>Figure 8.7 Circuit Configuration Using a PLC</p> <p>For details about the slide switch setting, refer to "Setting up the slide switches" on page 8-25.)</p>

■ Commands assigned to digital input terminals

Classification	Command	Command name	Functions	Related function codes																																																										
Commands assigned to digital input terminals	(FWD)	Run forward	(FWD) ON: The motor runs forward. (FWD) OFF: The motor decelerates and stops. When the (FWD) and (REV) are simultaneously ON, the inverter immediately decelerates and stops the motor. This command can be assigned only to terminals [FWD] and [REV].	E98, E99 (= 98)																																																										
	(REV)	Run reverse	(REV) ON: The motor runs reverse. (REV) OFF: The motor decelerates and stops. When (FWD) and (REV) are simultaneously ON, the inverter immediately decelerates and stops the motor. This command can be assigned only to terminals [FWD] and [REV].	E98, E99 (= 98)																																																										
	(SS1) (SS2) (SS4)	Select multistep frequency	8-step operation can be conducted with ON/OFF signals at (SS1), (SS2) and (SS4). Multistep frequency 0 indicates the frequency set by the keypad or analog signal. <table border="1" style="margin: 10px auto;"> <thead> <tr> <th colspan="2" rowspan="2"></th> <th colspan="8">Multistep frequency</th> </tr> <tr> <th>0</th><th>1</th><th>2</th><th>3</th><th>4</th><th>5</th><th>6</th><th>7</th> </tr> </thead> <tbody> <tr> <td>Digital input</td> <td></td> <td></td><td></td><td></td><td></td><td></td><td></td><td></td><td></td> </tr> <tr> <td>(SS1)</td> <td></td> <td>–</td><td>ON</td><td>–</td><td>ON</td><td>–</td><td>ON</td><td>–</td><td>ON</td> </tr> <tr> <td>(SS2)</td> <td></td> <td>–</td><td>–</td><td>ON</td><td>ON</td><td>–</td><td>–</td><td>ON</td><td>ON</td> </tr> <tr> <td>(SS4)</td> <td></td> <td>–</td><td>–</td><td>–</td><td>–</td><td>ON</td><td>ON</td><td>ON</td><td>ON</td> </tr> </tbody> </table>			Multistep frequency								0	1	2	3	4	5	6	7	Digital input										(SS1)		–	ON	–	ON	–	ON	–	ON	(SS2)		–	–	ON	ON	–	–	ON	ON	(SS4)		–	–	–	–	ON	ON	ON	ON	E01-E05, E98, E99 (= 0,1,2) C05-C11 = 0.00-120.0 Hz
			Multistep frequency																																																											
			0	1	2	3	4	5	6	7																																																				
	Digital input																																																													
	(SS1)		–	ON	–	ON	–	ON	–	ON																																																				
	(SS2)		–	–	ON	ON	–	–	ON	ON																																																				
	(SS4)		–	–	–	–	ON	ON	ON	ON																																																				
(HLD)	Enable 3-wire operation	Used for 3-wire operation. (HLD) ON: The inverter self-holds the command (FWD) or (REV). (HLD) OFF: The inverter releases self-holding.	E01-E05, E98, E99 (= 6)																																																											
(BX)	Coast to a stop	(BX) ON: The inverter output is stopped immediately and the motor will coast to stop. (No alarm signal will be output.)	E01-E05, E98, E99 (= 7)																																																											
(RST)	Reset alarm	(RST) ON: Alarm status is reset. (ON signal should be held for 10 ms or longer.)	E01-E05, E98, E99 (= 8)																																																											
(THR)	Enable external alarm trip	(THR) OFF: The inverter output is stopped and the motor coasts to stop. Alarm signal for the alarm code $\square Hz^2$ will be output.	E01-E05, E98, E99 (= 9)																																																											
(Hz2/Hz1)	Switch frequency command 2/1	(Hz2/Hz1) ON: Frequency command 2 is effective.	E01-E05, E98, E99 (= 11) F01 = 0-7 C30 = 0-7																																																											
(DCBRK)	Enable DC brake	(DCBRK) ON: Starts DC braking action.	E01-E05, E98, E99 (= 13) F20-F22																																																											

Classification	Command	Command name	Functions	Related function codes
Commands assigned to digital input terminals	(SW50)	Switch to commercial power (50 Hz)	(SW50) ON: Starts at 50 Hz.	E01-E05, E98, E99 (= 15)
	(SW60)	Switch to commercial power (60 Hz)	(SW60) ON: Starts at 60 Hz	E01-E05, E98, E99 (= 16)
	(UP)	UP (Increase output frequency)	(UP) ON: The output frequency rises while the circuit across (UP) and CM is connected.	E01-E05, E98, E99 (= 17) F01, C30, J02
	(DOWN)	DOWN (Decrease output frequency)	(DOWN) ON: The output frequency drops while the circuit across (DOWN) and CM is connected.	E01-E05, E98, E99 (= 18) F01, C30, J02
	(WE-KP)	Enable write from keypad	(WE-KP) ON: The function code data can be changed from the keypad. (Data can be changed when this function is not allocated.)	E01-E05, E98, E99 (= 19) F00
	(Hz/PID)	Cancel PID control	(Hz/PID) ON: This signal cancels the PID control and switches to the operation using the frequency determined by a multistep frequency command, keypad input, or analog input.  For details about J01 to J06 data, refer to Chapter 9, "FUNCTION CODES."	E01-E05, E98, E99 (= 20) J01-J06 J10-J19 F01 = 0-4 C30 = 0-4
	(IVS)	Switch normal/inverse operation	(IVS) ON: This signal switches the operation determined by frequency settings or PID control, between normal and inverse.	E01-E05, E98, E99 (= 21) C53, J01
	(IL)	Interlock	(IL) ON: This signal interlocks the inverter upon occurrence of a momentary power failure in order to thoroughly detect the power failure if an MC is inserted between the inverter and motor so that its auxiliary B contact is driven by commercial/factory power sources. Accordingly, this signal helps the inverter restart smoothly after a recovery from the power failure.	E01-E05, E98, E99 (= 22) F14

Classification	Command	Command name	Functions	Related function codes
Commands assigned to digital input terminals	(LE)	Enable communications link via RS-485 or field bus (option)	(LE) ON: While the circuit across (LE) and (CM) is short-circuited, the inverter runs according to commands sent via the standard or optional RS-485 or field bus (option) communications port.	E01-E05, E98, E99 (= 24) H30 = 3 y99
	(U-DI)	Universal DI	(U-DI) ON: An arbitrary digital input signal is transmitted to the host equipment.	E01-E05, E98, E99 (= 25)
	(STM)	Select starting characteristics	(STM) ON: Starting at the pick-up frequency becomes valid.	E01-E05, E98, E99 (= 26) H17, H09
	(STOP)	Force to stop	(STOP) ON: The inverter is forcibly stopped in the specified deceleration time.	E01-E05, E98, E99 (= 30) H56
	(PID-RST)	Reset PID integral and differential components	(PID-RST) ON: PID integration and differentiation are reset.	E01-E05, E98, E99 (= 33) J01-J06 J10-J19
	(PID-HLD)	Hold PID integral component	(PID-HLD) ON: PID integration is temporarily stopped.	E01-E05, E98, E99 (= 34) J01-J06 J10-J19
	(LOC)	Select local (keypad) operation	(LOC) ON: The run commands and frequency commands given at the keypad become valid.	E01-E05, E98, E99 (= 35)
	(RE)	Enable to run	(RE) ON: After a run command is input, operation starts upon activation of (RE).	E01-E05, E98, E99 (= 38)
	(DWP)	Protect motor from dew condensation	(DWP) ON: A current flows through the motor to avoid motor temperature drop during inverter stoppage so that dew condensation will not occur.	E01-E05, E98, E99 (= 39) J21, F21, F22

Classification	Command	Command name	Functions	Related function codes
Commands assigned to digital input terminals	(ISW50)	Enable integrated sequence to switch to commercial power (50 Hz)	(ISW50) ON: Line operation starts according to the switching sequence built in the inverter. (For 50 Hz commercial line)	E01-E05, E98, E99 (= 40) J22
	(ISW60)	Enable integrated sequence to switch to commercial power (60 Hz)	(ISW60) ON: Line operation starts according to the switching sequence built in the inverter. (For 60 Hz commercial line)	E01-E05, E98, E99 (= 41) J22
	(FR2/FR1)	Switch run command 2/1	(FR2/FR1) ON: The run command source switches to (FWD2) or (REV2) side.	E01-E05, E98, E99 (= 87) F02
	(FWD2)	Run forward 2	(FWD2) ON: The motor runs forward. (FWD2) OFF: The motor decelerates and stops. When (FWD2) and (REV2) are simultaneously ON, the inverter immediately decelerates and stops the motor.	E01-E05, E98, E99 (= 88)
	(REV2)	Run reverse 2	(REV2) ON: The motor runs reverse. (REV2) OFF: The motor decelerates and stops. When (FWD2) and (REV2) are simultaneously ON, the inverter immediately decelerates and stops the motor.	E01-E05, E98, E99 (= 89)

Analog output, pulse output, transistor output, and relay output terminals

Classification	Symbol	Name	Functions	Related function codes
Analog output	[FMA]	Analog monitor	<p>The monitor signal for analog DC voltage (0 to +10 V) or analog DC current (+4 to +20 mA) is output. You can select either one of the output switching the slide switch SW4 on the control PCB (Refer to "<u>Setting up the slide switches</u>" on page 8-25.), and changing data of the function code F29. You can also select the signal functions following with function code F31.</p> <ul style="list-style-type: none"> • Output frequency • Output voltage • Load factor • PID feedback value • Universal AO • Calibration • PID output • Output current • Output torque • Input power • DC link bus voltage • Motor output • PID command <p>* Input impedance of external device: Min. 5kΩ (0 to 10 VDC output)</p> <p>Input impedance of external device: Max. 500Ω (4 to 20 mA DC output)</p> <p>* While the terminal is outputting 0 to 10 VDC, an output less than 0.3 V may become 0.0 V.</p> <p>* While the terminal is outputting 0 to 10 VDC, it is capable to drive up to two meters with 10kΩ impedance. While outputting the current, to drive a meter with 500Ω impedance max. (Adjustable range of the gain: 0 to 200%)</p>	F29-F31
	[FMI]	Analog monitor	<p>The monitor signal for analog DC current (+4 to +20 mA) is output. You can select one of the following signal functions with function code F35.</p> <ul style="list-style-type: none"> • Output frequency • Output voltage • Load factor • PID feedback value • Universal AO • Calibration • PID output • Output current • Output torque • Input power • DC link bus voltage • Motor output • PID command <p>* Input impedance of the external device: Max. 500Ω</p> <p>It is capable of driving a meter with a maximum of 500Ω impedance. (Adjustable gain range: 0 to 200%)</p>	F34,F35
	[11]	Analog common	<p>Two common terminals for analog input and output signal terminals</p> <p>These terminals are electrically isolated from terminals [CM]s and [CMY].</p>	
Pulse output	[CM]	Digital common	<p>Two common terminals for digital input signal terminals and an output terminal [FMP]</p> <p>These terminals are electrically isolated from other common terminals, [11]s and [CMY].</p> <p>These are the shared terminals with the common terminal [CM]s of the digital inputs.</p>	

Classification	Symbol	Name	Functions	Related function codes
Transistor output	[Y1]	Transistor output 1	<p>(1) Various signals such as inverter running, speed/freq. arrival and overload early warning can be assigned to any terminals, [Y1] to [Y3] by setting function code E20, E21 and E22. Refer to Chapter 9, Section 9.2 "Overview of Function Codes" for details.</p> <p>(2) Switches the logic value (1/0) for ON/OFF of the terminals between [Y1] to [Y3] and [CMY]. If the logic value for ON between [Y1] to [Y3] and [CMY] is 1 in the normal logic system, for example, OFF is 1 in the negative logic system and vice versa.</p> <p>Transistor output circuit specification</p> 	E20
	[Y2]	Transistor output 2		E21
	[Y3]	Transistor output 3		E22
		[CMY]	Transistor output common	<p>Common terminal for transistor output signal terminals</p> <p>This terminal is electrically isolated from terminals, [CM]s and [11]s.</p>

Figure 8.8 Transistor Output Circuit

Item		Max.
Operation voltage	ON level	3 V
	OFF level	27 V
Maximum load current at ON		50 mA
Leakage current at OFF		0.1 mA

Figure 8.9 shows examples of connection between the control circuit and a PLC.

Note

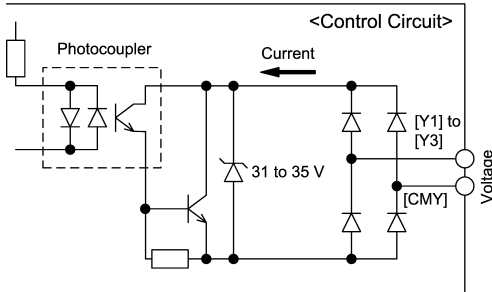
- When a transistor output drives a control relay, connect a surge-absorbing diode across relay's coil terminals.
- When any equipment or device connected to the transistor output needs to be supplied with DC power, feed the power (+24 VDC: allowable range: +22 to +27 VDC, 50 mA max.) through the [PLC] terminal. Short-circuit between the terminals [CMY] and [CM] in this case.

Classification	Symbol	Name	Functions	Related function codes
Transistor output	<p>Tip ■ Connecting Programmable Controller (PLC) to Terminal [Y1], [Y2] or [Y3]</p> <p>Figure 8.9 shows two examples of circuit connection between the transistor output of the inverter's control circuit and a PLC. In example (a), the input circuit of the PLC serves as a sink for the control circuit output, whereas in example (b), it serves as a source for the output.</p>		<p>(a) PLC serving as Sink</p> <p>(b) PLC serving as Source</p>	
Relay output	[Y5A/C]	General purpose relay output	<p>(1) A general-purpose relay contact output usable as well as the function of the transistor output terminal [Y1], [Y2] or [Y3]. Contact rating: <u>250 VAC 0.3 A, cos φ = 0.3</u>, <u>48 VDC, 0.5 A</u></p> <p>(2) Switching of the normal/negative logic output is applicable to the following two contact output modes: "Active ON" (Terminals [Y5A] and [Y5C] are closed (excited) if the signal is active.) and "Active OFF" (Terminals [Y5A] and [Y5C] are opened (non-excited) if the signal is active while they are normally closed.).</p>	E24
Relay output	[30A/B/C]	Alarm relay output (for any error)	<p>(1) Outputs a contact signal (SPDT) when a protective function has been activated to stop the motor. Contact rating: <u>250 VAC, 0.3A, cos φ = 0.3</u>, <u>48 VDC, 0.5A</u></p> <p>(2) Any one of output signals assigned to terminals [Y1] to [Y3] can also be assigned to this relay contact to use it for signal output.</p> <p>(3) Switching of the normal/negative logic output is applicable to the following two contact output modes: "Terminals [30A] and [30C] are closed (excited) for ON signal output (Active ON)" or "Terminals [30B] and [30C] are closed (non-excited) for ON signal output (Active OFF)."</p>	E27

■ Signals assigned to transistor output terminals

Classification	Signal	Signal name	Functions	Related function codes
Signals assigned to transistor output terminals	(RUN)	Inverter running	Comes ON when the output frequency is higher than the starting frequency.	E20-E22, E24, E27 (= 0)
	(RUN2)	Inverter output on	Comes ON when the inverter runs at the frequency lower than the starting frequency or when DC braking is in action.	E20-E22, E24, E27 (= 35)
	(FAR)	Frequency arrival signal	Comes ON when the output frequency arrives the reference frequency. (Hysteresis band (fixed): 2.5 Hz)	E20-E22, E24, E27 (= 1)
	(FDT)	Frequency detected	Comes ON when the output frequency exceeds the preset detection level. This signal goes off when the output frequency drops below the preset detection level. (Hysteresis band (fixed): 1.0 Hz)	E20-E22, E24, E27 (= 2) E31
	(LU)	Undervoltage detected	Comes ON when the inverter stops its output because of undervoltage while the run command is ON.	E20-E22, E24, E27 (= 3)
	(IOL)	Inverter output limiting	Comes ON when the inverter is limiting the current or is under the anti-regenerative control.	E20-E22, E24, E27 (= 5) F43, F44 H12, H69
	(IPF)	Auto-restarting after momentary power failure	Comes ON during auto-restarting operation (after a recovery from momentary power failure and until completion of restart).	E20-E22, E24, E27 (= 6) F14
	(OL)	Motor overload early warning	Comes ON when the calculated value of the electronic thermal simulator is higher than the preset alarm level.	E20-E22, E24, E27 (= 7) F10-F12
	(RDY)	Inverter ready to run	Comes ON when the inverter becomes ready to run.	E20-E22, E24, E27 (= 10)
	(SW88)	Switch motor drive source between commercial power and inverter output	Controls the magnetic contactor located at the commercial power line side, for switching the motor drive source between the commercial power lines and the inverter outputs.	E20-E22, E24, E27 (= 11)

Classification	Signal	Signal name	Functions	Related function codes
Signals assigned to transistor output terminal	(SW52-2)	Switch motor drive source between commercial power and inverter output	Controls the magnetic contactor located at the inverter output side (secondary side), for switching the motor drive source between the commercial power line and the inverter.	E20-E22, E24, E27 (= 12)
	(SW52-1)	Switch motor drive source between commercial power and inverter output	Controls the magnetic contactor located at the inverter input side (primary side), for switching the motor drive source between the commercial power line and the inverter.	E20-E22, E24, E27 (= 13)
	(AX)	Select AX terminal function	Controls the magnetic contactor located at the inverter input side (primary side).	E20-E22, E24, E27 (= 15)
	(FAN)	Cooling fan in operation	Comes ON when the cooling fan is running.	E20-E22, E24, E27 (= 25) H06
	(TRY)	Auto-resetting	Comes ON when the retry function is activated (H04 ≠ 0).	E20-E22, E24, E27 (= 26) H04, H05
	(U-DO)	Universal DO	Comes ON to command a peripheral apparatus according to signals sent from the host equipment.	E20-E22, E24, E27 (= 27)
	(OH)	Heat sink overheat early warning	Comes ON as a forecast warning before the inverter trips due to a heat sink overheated. This signal also comes ON if the internal air circulation DC fan (used in 200 V class series inverters of 45 kW or above or 400 V class series inverters of 55 kW or above) locks.	E20-E22, E24, E27 (= 28)
	(LIFE)	Service life alarm	Outputs alarm signals according to the preset lifetime level. This signal also comes ON if the internal air circulation DC fan (used in 200 V class series inverters of 45 kW or above or 400 V class series inverters of 55 kW or above) locks.	E20-E22, E24, E27 (= 30) H42, H43, H98
	(REF OFF)	Command loss detected	Comes ON when a frequency command missing condition is detected.	E20-E22, E24, E27 (= 33) E65
	(OLP)	Overload prevention control	Comes ON during inverter control for avoiding overload.	E20-E22, E24, E27 (= 36) H70

Classification	Signal	Signal name	Functions	Related function codes
Signals assigned to transistor output terminal	(ID)	Current detected	Comes ON when a current larger than the preset value has been detected for the preset timer count.	E20-E22, E24, E27 (= 37) E34, E35
	(PID-ALM)	PID alarm	Signals an absolute-value alarm (J11 = 0 to 3) or deviation-value alarm (J11 = 4 to 7) under PID control.	E20-E22, E24, E27 (= 42) J11 to J13
	(PID-CTL)	Under PID control	Comes ON when the PID control is active.	E20-E22, E24, E27 (= 43)
	(PID-STP)	Motor stopping due to slow flowrate under PID control	Comes ON if operation is stopped due to slow water flowrate under PID control. (The inverter is stopped even if the operation command is issued.)	E20-E22, E24, E27 (= 44) J15 to J17
	(U-TL)	Low output torque detected	Comes ON if the torque value has been below the preset level for the time elapsed longer than the specified timer count.	E20-E22, E24, E27 (= 45) E80 to E81
	(RMT)	Inverter in remote operation	Comes ON when the inverter is in Remote mode.	E20-E22, E24, E27 (= 54)
	(AX2)	Run command activated	Comes ON when the inverter receives a run command and becomes ready to run.	E20-E22, E24, E27 (= 55)
	(THM)	Motor overheat detected (PTC)	Comes ON when a temperature alarm condition is detected by a PTC thermistor in the motor but the inverter is running the motor instead of issuing $\overline{O/H}$.	E20-E22, E24, E27 (= 56) H26, H27
(ALM)	Alarm output (for any alarm)	Comes ON as a transistor output signal.	E20-E22, E24, E27 (= 99)	

RS-485 communications port

Classification	Connector	Name	Functions	Related function codes
Communication	RJ-45 connector for the keypad	Standard RJ-45 connector	<p>(1) Used to connect the inverter with PC or PLC using RS-485 port. The inverter supplies the power to the keypad through the pins specified below. The extension cable for remote operation also uses wires connected to these pins for supplying the keypad power.</p> <p>(2) Remove the keypad from the standard RJ-45 connector, and connect the RS-485 communications cable to control the inverter through the PC or PLC (Programmable Logic Controller). Refer to "Setting up the slide switches" on page 8-25 for setting of the terminating resistor.</p>	H30, y01-y10, y98, y99
		<p>Figure 8.10 RJ-45 Connector and its Pin Assignment*</p> <p>* Pins 1, 2, 7, and 8 are exclusively assigned to power lines for the keypad, so do not use those pins for any other equipment.</p>		



- Route the wiring of the control terminals as far from the wiring of the main circuit as possible. Otherwise electric noise may cause malfunctions.
- Fix the control circuit wires inside the inverter to keep them away from the live parts of the main circuit (such as the terminal block of the main circuit).

Setting up the slide switches

Switching the slide switches located on the control PCB allows you to customize the operation mode of the analog output terminals, digital I/O terminals, and communications ports. The locations of those switches are shown in Figure 8.11.

To access the slide switches, remove the front and terminal block covers so that you can watch the control PCB. For models of 37 kW or above, open also the keypad enclosure.

 For details on how to remove the front cover, terminal block cover, and keypad enclosure, refer to the FRENIC-Eco Instruction Manual (INR-SI47-1059-E), Chapter 2, Section 2.3.1, "Removing and mounting the terminal block (TB) cover and the front cover" and Chapter 1, Section 1.2, "External View and Terminal Blocks," Figure 1.4.

Table 8.1 lists the function of each slide switch.

Table 8.1 Function of Each Slide Switch

Slide Switch	Function									
① SW1	<p>Switches the service mode of the digital input terminals between SINK and SOURCE.</p> <ul style="list-style-type: none"> ▪ To make the digital input terminal [X1] to [X5], [FWD] or [REV] serve as a current sink, turn SW1 to the SINK position. ▪ To make them serve as a current source, turn SW1 to the SOURCE position. Factory default: SOURCE 									
② SW3	<p>Switches the terminating resistor of RS-485 communications port on the inverter on and off.</p> <ul style="list-style-type: none"> ▪ To connect a keypad to the inverter, turn SW3 to OFF. (Factory default) ▪ If the inverter is connected to the RS-485 communications network as a terminating device, turn SW3 to ON. 									
③ SW4	<p>Switches the output mode of the analog output terminal [FMA] between voltage and current. When changing this switch setting, also change the data of function code F29.</p> <table border="1" style="width: 100%; border-collapse: collapse;"> <thead> <tr> <th></th> <th>SW4</th> <th>Set data of F29 to:</th> </tr> </thead> <tbody> <tr> <td>Voltage output (Factory default)</td> <td>VO</td> <td>0</td> </tr> <tr> <td>Current output</td> <td>IO</td> <td>1</td> </tr> </tbody> </table>		SW4	Set data of F29 to:	Voltage output (Factory default)	VO	0	Current output	IO	1
	SW4	Set data of F29 to:								
Voltage output (Factory default)	VO	0								
Current output	IO	1								
④ SW5	<p>Switches property of the analog input terminal [V2] for V2 or PTC. When changing this switch setting, also change the data of function code H26.</p> <table border="1" style="width: 100%; border-collapse: collapse;"> <thead> <tr> <th></th> <th>SW5</th> <th>Set data of H26 to:</th> </tr> </thead> <tbody> <tr> <td>Analog frequency setting in voltage (Factory default)</td> <td>V2</td> <td>0</td> </tr> <tr> <td>PTC thermistor input</td> <td>PTC</td> <td>1 or 2</td> </tr> </tbody> </table>		SW5	Set data of H26 to:	Analog frequency setting in voltage (Factory default)	V2	0	PTC thermistor input	PTC	1 or 2
	SW5	Set data of H26 to:								
Analog frequency setting in voltage (Factory default)	V2	0								
PTC thermistor input	PTC	1 or 2								

Figure 8.11 shows the location of slide switches for the input/output terminal configuration.

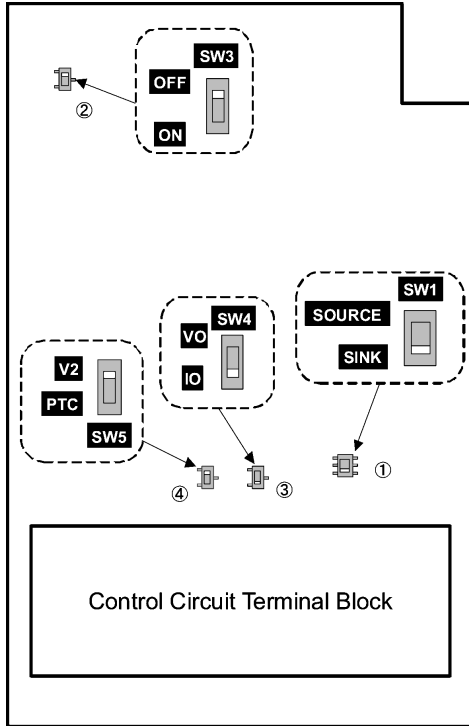

Switching example

SW1

SINK	SOURCE
<p>SINK</p>	<p>SOURCE</p>

Figure 8.11 Location of the Slide Switches

8.4.2 Terminal arrangement diagram and screw specifications

8.4.2.1 Main circuit terminals

The table below shows the main circuit screw sizes, tightening torque and terminal arrangements. Note that the terminal arrangements differ according to the inverter types. Two terminals designed for grounding shown as the symbol,  in Figures A to I make no distinction between a power supply source (a primary circuit) and a motor (a secondary circuit).

Table 8.2 Main Circuit Terminal Properties

Power supply voltage	Nominal applied motor (kW)	Inverter type	Terminal screw size	Tightening torque (N·m)	Grounding screw size	Tightening torque (N·m)	Refer to:
Three-phase 400 V	0.75	FRN0.75F1S-4E	M4	1.8	M4	1.8	Figure A
	1.5	FRN1.5F1S-4E					
	2.2	FRN2.2F1S-4E					
	4.0	FRN4.0F1S-4E					
	5.5	FRN5.5F1S-4E	M5	3.8	M5	3.8	Figure B
	7.5	FRN7.5F1S-4E					
	11	FRN11F1S-4E	M6	5.8	M6	5.8	Figure C
	15	FRN15F1S-4E					
	18.5	FRN18.5F1S-4E					
	22	FRN22F1S-4E	M8	13.5	M8	13.5	Figure D
	30	FRN30F1S-4E					
	37	FRN37F1S-4E					
	45	FRN45F1S-4E					
	55	FRN55F1S-4E	M10	27	M8	13.5	Figure E
	75	FRN75F1S-4E					
	90	FRN90F1S-4E					
	110	FRN110F1S-4E					
	132	FRN132F1S-4E	M12	48	M10	27	Figure F
	160	FRN160F1S-4E					
	200	FRN200F1S-4E					
220	FRN220F1S-4E						
280	FRN280F1S-4E						
315	FRN315F1S-4E						
355	FRN355F1S-4E						
400	FRN400F1S-4E						
450	FRN450F1S-4E	Figure J					
500	FRN500F1S-4E						
560	FRN560F1S-4E	Figure K					
		Figure L					

Terminal R0, T0 (Common to all types): Screw size M3.5, Tightening torque 1.2 (N·m)

Terminal R1, T1: Screw size M3.5, Tightening torque 0.9 (N·m) for the models of 400 V class series 55 kW or above

Figure A

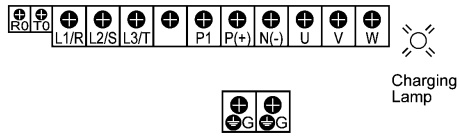

Figure B

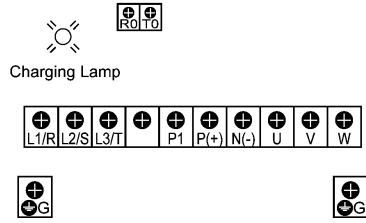

Figure C

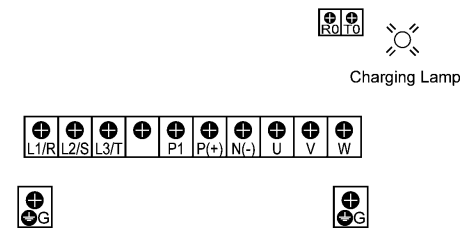

Figure D

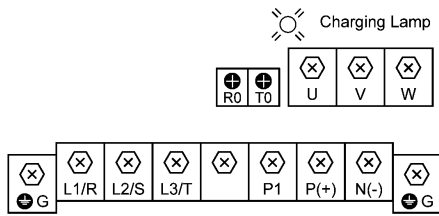

Figure E

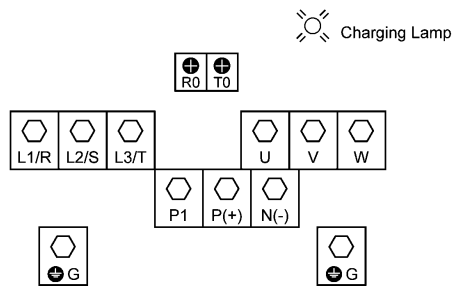

Figure F

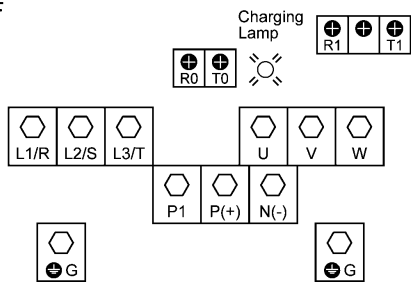

Figure G

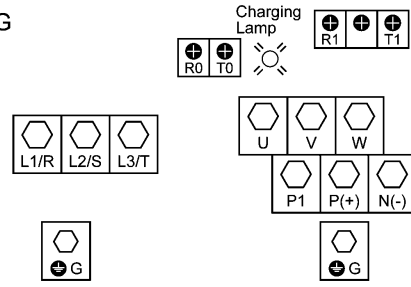

Figure H

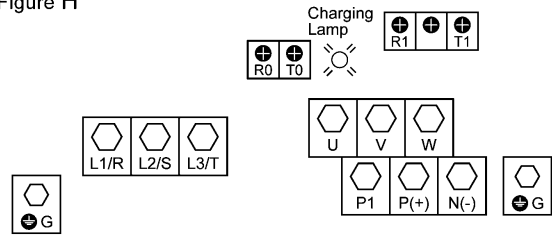

Figure I

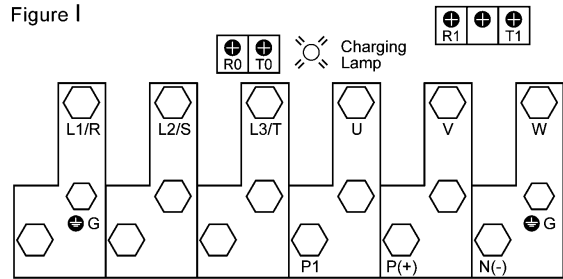

Figure J

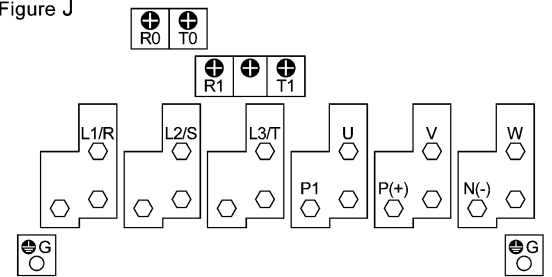

Figure K

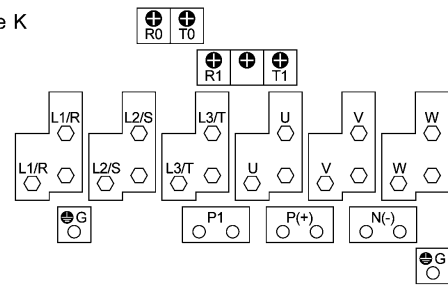
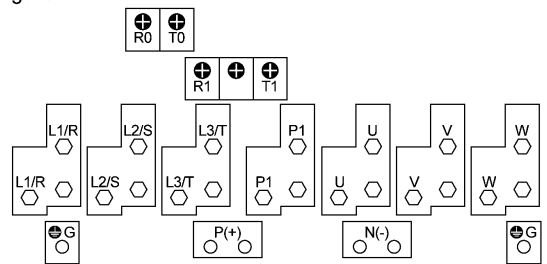
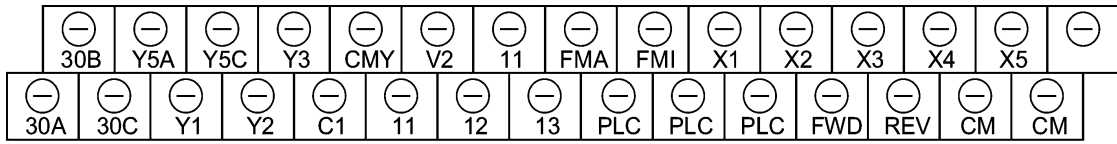

Figure L



8.4.2.2 Control circuit terminals

The control circuit terminal arrangement, screw sizes, and tightening torque are shown below.



Screw size: M3 Tightening torque: 0.5 to 0.6 (N·m)

Control Circuit Terminals

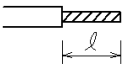
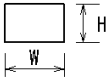
Screwdriver type	Allowable wire size	Wire strip length 	Dimension of openings in the control circuit terminals for ferrule (for Europe type terminals)* 
Flat screwdriver (0.6 x 3.5 mm)	AWG26 to AWG16 (0.14 to 1.5 mm ²)	7 mm	2.75 (W) x 2.86 (H) mm

* Manufacturer of ferrules: Phoenix Contact Inc. Refer to the table below.

Recommended Ferrule Terminals

Screw size	Type	
	With insulated collar	Without insulated collar
AWG24 (0.25 mm ²)	AI0.25-6BU	-
AWG22 (0.34 mm ²)	AI0.34-6TQ	A0.34-7
AWG20 (0.5 mm ²)	AI0.5-6WH	A0.5-6
AWG18 (0.75 mm ²)	AI0.75-6GY	A0.75-6
AWG16 (1.25 mm ²)	AI1.5-6BK	A1.5-7

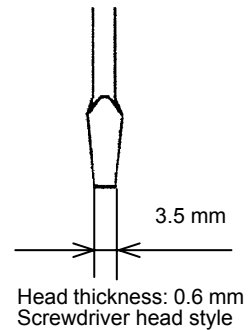

8.5 Operating Environment and Storage Environment

8.5.1 Operating environment

Install the inverter in an environment that satisfies the requirements listed in Table 8.3.

Table 8.3 Environmental Requirements

Item	Specifications			
Site location	Indoors			
Ambient temperature	-10 to +50°C (Note 1)			
Relative humidity	5 to 95% (No condensation)			
Atmosphere	<p>The inverter must not be exposed to dust, direct sunlight, corrosive gases, flammable gas, oil mist, vapor or water drops. Pollution degree 2 (IEC60664-1) (Note 2)</p> <p>The atmosphere can contain a small amount of salt. (0.01 mg/cm² or less per year)</p> <p>The inverter must not be subjected to sudden changes in temperature that will cause condensation to form.</p>			
Altitude	1,000 m max. (Note 3)			
Atmospheric pressure	86 to 106 kPa			
Vibration	For <u>models of 75 kW or below</u>		For <u>models of 90 kW or above and IP54 series inverters</u>	
	3 mm (Max. amplitude)	2 to less than 9 Hz	3 mm (Max. amplitude)	2 to less than 9 Hz
	9.8 m/s ²	9 to less than 20 Hz	2 m/s ²	9 to less than 55 Hz
	2 m/s ²	20 to less than 55 Hz	1 m/s ²	55 to less than 200 Hz
	1 m/s ²	55 to less than 200 Hz		

(Note 1) When inverters are mounted side-by-side without any gap between them (5.5 kW or less), the ambient temperature should be within the range from -10 to +40°C.

(Note 2) Do not install the inverter in an environment where it may be exposed to cotton waste or moist dust or dirt which will clog the heat sink in the inverter. If the inverter is to be used in such an environment, install it in the panel of your system or other dustproof containers.

(Note 3) If you use the inverter in an altitude above 1000 m, you should apply an output current derating factor as listed in Table 8.4.

Table 8.4 Output Current Derating Factor in Relation to Altitude

Altitude	Output current derating factor
1000 m or lower	1.00
1000 to 1500 m	0.97
1500 to 2000 m	0.95
2000 to 2500 m	0.91 (Note 4)
2500 to 3000 m	0.88 (Note 4)

(Note 4) For the location with altitude of 2000 m or higher, insulate interface circuits/lines of the inverter from the main power source/lines for complying with Low Voltage Directive.

8.5.2 Storage environment

8.5.2.1 Temporary storage

Store the inverter in an environment that satisfies the requirements listed below.

Table 8.5 Storage and Transport Environments

Item	Specifications	
Storage temperature ^{*1}	-25 to +70°C	Places not subjected to abrupt temperature changes or condensation or freezing
Relative humidity	5 to 95% ^{*2}	
Atmosphere	The inverter must not be exposed to dust, direct sunlight, corrosive or flammable gases, oil mist, vapor, water drops or vibration. The atmosphere must contain only a low level of salt. (0.01 mg/cm ² or less per year)	
Atmospheric pressure	86 to 106 kPa (during storage)	
	70 to 106 kPa (during transportation)	

*1 Assuming a comparative short time storage, e.g., during transportation or the like.

*2 Even if the humidity is within the specified requirements, avoid such places where the inverter will be subjected to sudden changes in temperature that will cause condensation to form.

Precautions for temporary storage

- (1) Do not leave the inverter directly on the floor.
- (2) If the environment does not satisfy the specified requirements listed above, wrap the inverter in an airtight vinyl sheet or the like for storage.
- (3) If the inverter is to be stored in a high-humidity environment, put a drying agent (such as silica gel) in the airtight package described in item (2).

8.5.2.2 Long-term storage

The long-term storage method of the inverter varies largely according to the environment of the storage site. General storage methods are described below.

- (1) The storage site must satisfy the requirements specified for temporary storage. However, for storage exceeding three months, the ambient temperature range should be within the range from -10 to 30°C. This is to prevent electrolytic capacitors in the inverter from deterioration.
- (2) The package must be airtight to protect the inverter from moisture. Add a drying agent inside the package to maintain the relative humidity inside the package within 70%.
- (3) If the inverter has been installed to the equipment or panel at construction sites where it may be subjected to humidity, dust or dirt, then temporarily remove the inverter and store it in the environment specified in Table 8.5.

Precautions for storage over 1 year

If the inverter has not been powered on for a long time, the property of the electrolytic capacitors may deteriorate. Power the inverters on once a year and keep the inverters powering on for 30 to 60 minutes. Do not connect the inverters to the load circuit (secondary side) or run the inverter.

8.6 External Dimensions

8.6.1 Standard models

The diagrams below show external dimensions of the FRENIC-Eco series of inverters according to the type.

Unit: mm

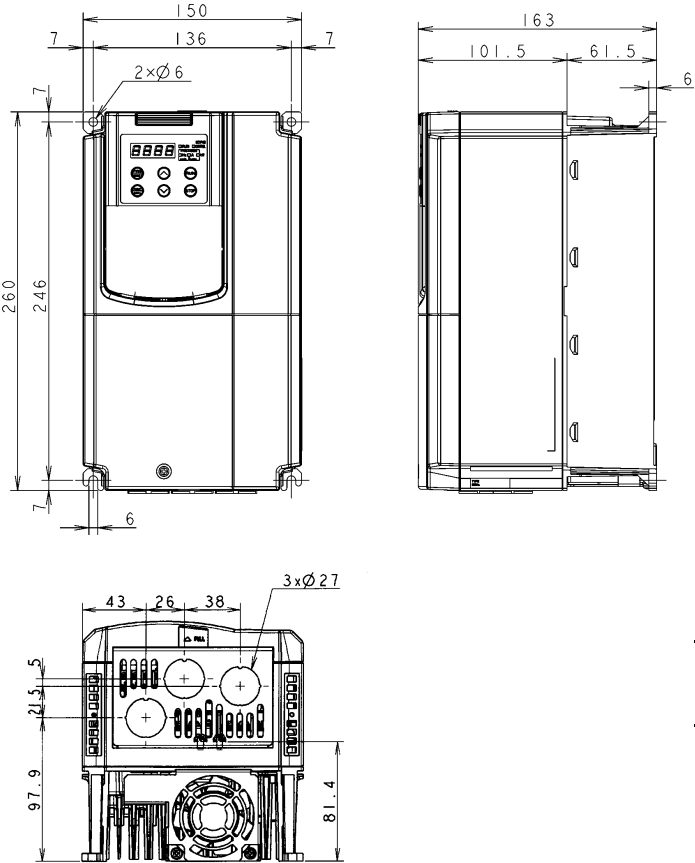

Power supply voltage	Type
Three-phase 400 V	FRN0.75F1S-4E
	FRN1.5F1S-4E
	FRN2.2F1S-4E
	FRN4.0F1S-4E
	FRN5.5F1S-4E

8.5 External Dimensions

Unit: mm

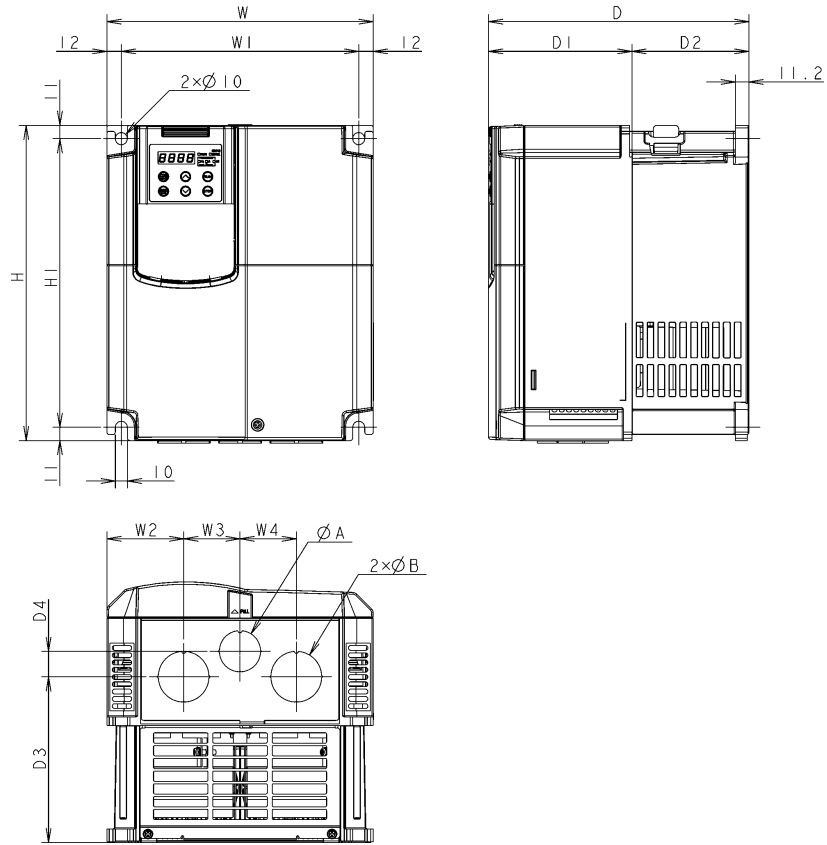

Power supply voltage	Type	Dimensions (mm)													
		W	W1	W2	W3	W4	H	H1	D	D1	D2	D3	D4	fA	fB
Three-phase 400 V	FRN7.5F1S-4E	220	196	63.5	46.5	46.5	260	238	215	118.5	96.5	141.7	16	27	34
	FRN11F1S-4E														
	FRN15F1S-4E														
	FRN18.5F1S-4E	250	226	67	58	58	400	378		85	130	166.2	2	34	42
	FRN22F1S-4E														
	FRN30F1S-4E														

Unit: mm

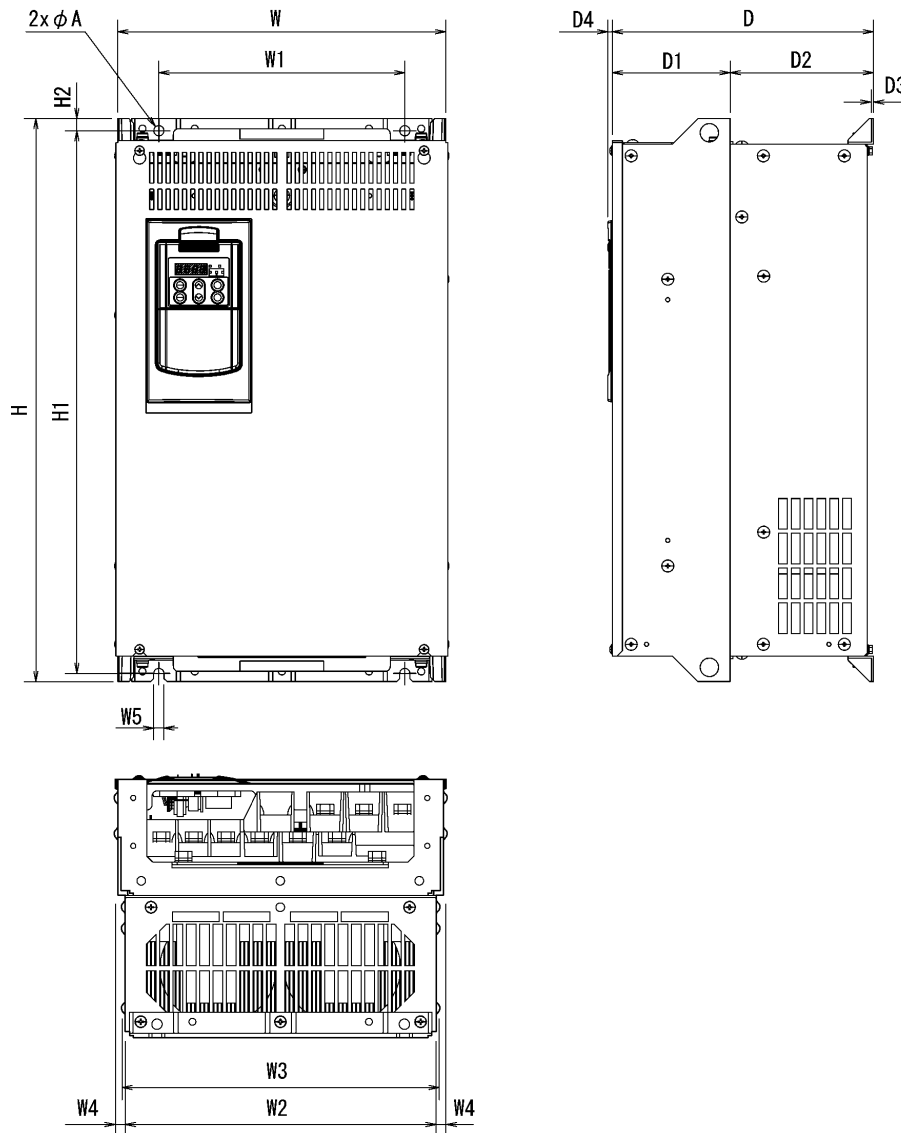

Power supply voltage	Type	Dimensions (mm)														
		W	W1	W2	W3	W4	W5	H	H1	H2	D	D1	D2	D3	D4	fA
Three-phase 400 V	FRN37F1S-4E	320	240	304	310.2	8	10	550	530	12	255	115	140	4	4.5	10
	FRN45F1S-4E										270					
	FRN55F1S-4E										300	145				
	FRN75F1S-4E	355	275	339	345.2	13.5	15	615	595	15.5	315	135	180	6.4	6	15
	FRN90F1S-4E										360	180				
	FRN110F1S-4E	530	430	503	509.2	13.5	15	740	720	15.5	380	200	180	6.4	6	15
	FRN132F1S-4E										315	135				
	FRN160F1S-4E										360	180				
	FRN200F1S-4E	680	580	653	659	13.5	15	1000	970	15.5	380	200	180	6.4	6	15
	FRN220F1S-4E										380	200				
	FRN280F1S-4E	880	780	853	859	13.5	15	1400	1370	15.5	440	260	180	6.4	6	15
	FRN315F1S-4E										380	200				
	FRN355F1S-4E										380	200				
	FRN400F1S-4E	880	780	853	859	13.5	15	1400	1370	15.5	440	260	180	6.4	6	15
	FRN450F1S-4E										380	200				
FRN500F1S-4E	880	780	853	859	13.5	15	1400	1370	15.5	440	260	180	6.4	6	15	
FRN560F1S-4E										380	200					

8.6.2 DC reactor

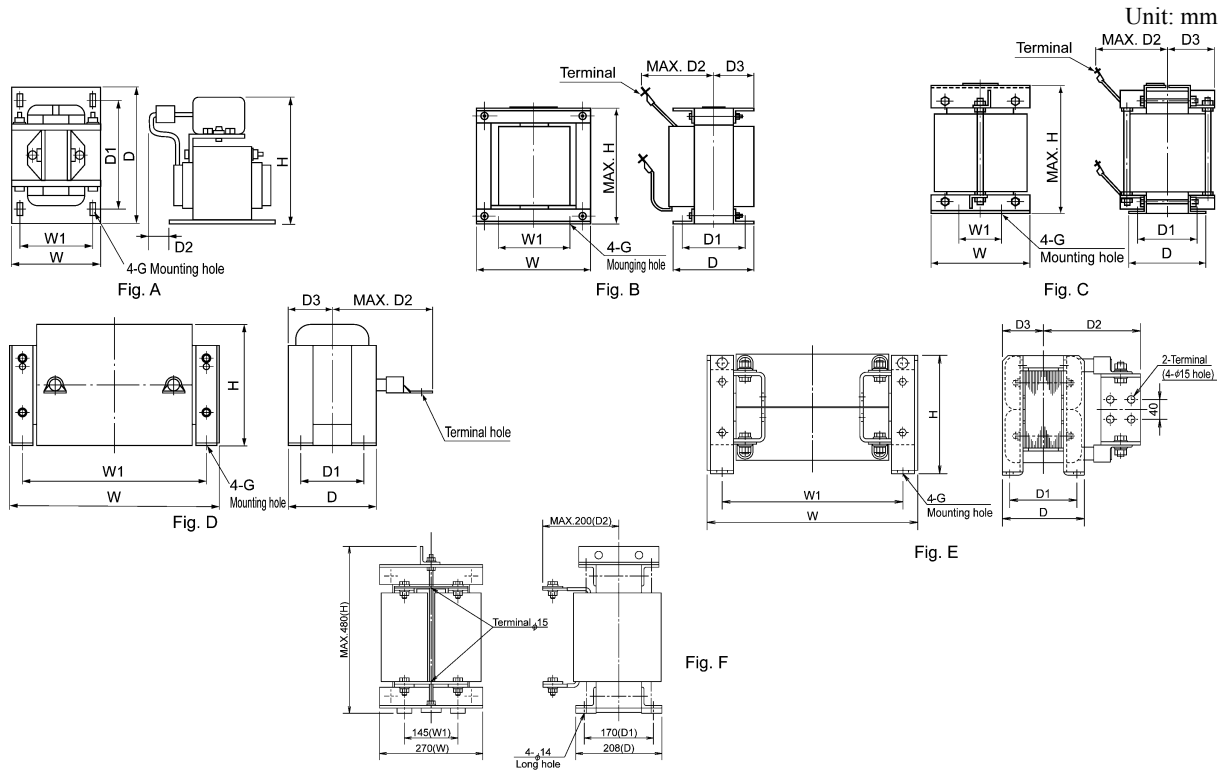

Power supply voltage	Applicable motor rating (kW)	Inverter type	REACTOR type	Fig.	Dimension (mm)										Mass (kg)
					W	W1	D	D1	D2	D3	H	Mounting hole	Terminal hole		
Three-phase 200V	0.75	FRN0.75F1□-2E	DCR2-0.75	A	66	56	90	72	20	—	94	5.2 x 8	M4	1.4	
	1.5	FRN1.5F1□-2E	DCR2-1.5	A	66	56	90	72	20	—	94	5.2 x 8	M4	1.6	
	2.2	FRN2.2F1□-2E	DCR2-2.2	A	86	71	100	80	10	—	110	6 x 11	M4	1.8	
	3.7	FRN3.7F1□-2E	DCR2-3.7	A	86	71	100	80	20	—	110	6 x 11	M4	2.6	
	5.5	FRN5.5F1□-2E	DCR2-5.5	A	111	95	100	80	20	—	130	7 x 11	M5	3.6	
	7.5	FRN7.5F1□-2E	DCR2-7.5	A	111	95	100	80	23	—	130	7 x 11	M5	3.8	
	11	FRN11F1□-2E	DCR2-11	A	111	95	100	80	24	—	137	7 x 11	M6	4.3	
	15	FRN15F1□-2E	DCR2-15	A	146	124	120	96	15	—	171	7 x 11	M6	5.9	
	18.5	FRN18.5F1□-2E	DCR2-18.5	A	146	124	120	96	25	—	180	7 x 11	M8	7.4	
	22	FRN22F1□-2E	DCR2-22A	A	146	124	120	96	25	—	180	7 x 11	M8	7.5	
	30	FRN30F1□-2E	DCR2-30B	B	152±3	90±1	156±3	116±2	115	78±5	130	8	M8	12	
	37	FRN37F1□-2E	DCR2-37B	B	171±3	110±1	151±3	110±2	115	75±5	150	8	M8	14	
	45	FRN45F1□-2E	DCR2-45B	B	171±3	110±1	166±3	125±2	120	86±5	150	8	M10	16	
	55	FRN55F1□-2E	DCR2-55B	C	190±3	160±1	131±3	90±2	100	65±5	210	8	M12	16	
	75	FRN75F1□-2E	DCR2-75C	D	255±10	225	106±2	86±1	145	53±1	145	6	M12	11.4	
	90	FRN90F1□-2E	DCR2-90C	D	255±10	225	116±2	96	155	58±1	145	M6	M12	14	
	110	FRN110F1□-2E	DCR2-110C	D	300±10	265	116±4	90	185	58±2	160	M8	M12	17	
	Three-phase 400V	0.75	FRN0.75F1□-4E	DCR4-0.75	A	66	56	90	72	20	—	94	5.2 x 8	M4	1.4
1.5		FRN1.5F1□-4E	DCR4-1.5	A	66	56	90	72	20	—	94	5.2 x 8	M4	1.6	
2.2		FRN2.2F1□-4E	DCR4-2.2	A	86	71	100	80	15	—	110	6 x 9	M4	2	
3.7		FRN3.7F1□-4E	DCR4-3.7	A	86	71	100	80	20	—	110	6 x 9	M4	2.6	
5.5		FRN5.5F1□-4E	DCR4-5.5	A	86	71	100	80	20	—	110	6 x 9	M4	2.6	
7.5		FRN7.5F1□-4E	DCR4-7.5	A	111	95	100	80	24	—	130	7 x 11	M5	4.2	
11		FRN11F1□-4E	DCR4-11	A	111	95	100	80	24	—	130	7 x 11	M5	4.3	
15		FRN15F1□-4E	DCR4-15	A	146	124	120	96	15	—	171	7 x 11	M5	5.9	
18.5		FRN18.5F1□-4E	DCR4-18.5	A	146	124	120	96	25	—	171	7 x 11	M6	7.2	
22		FRN22F1□-4E	DCR4-22A	A	146	124	120	96	25	—	171	7 x 11	M6	7.2	
30		FRN30F1□-4E	DCR4-30B	B	152±3	90±1	157±3	115±2	100	78±5	130	8	M8	13	
37		FRN37F1□-4E	DCR4-37B	B	171±3	110±1	150±3	110±2	100	75±5	150	8	M8	15	
45		FRN45F1□-4E	DCR4-45B	B	171±3	110±1	165±3	125±2	110	82±5	150	8	M8	18	
55		FRN55F1□-4E	DCR4-55B	B	171±3	110±1	170±3	130±2	110	85±5	150	8	M8	20	
75		FRN75F1□-4E	DCR4-75C	D	255±10	225	106±2	86±1	125	53±1	145	6	M10	12.4	
90		FRN90F1□-4E	DCR4-90C	D	256±10	225	116±2	96±1	130	58±1	145	6	M12	14.7	
110		FRN110F1□-4E	DCR4-110C	D	306±10	265	116±4	90±2	140	58±2	155	8	M12	18.4	
132		FRN132F1□-4E	DCR4-132C	D	306±10	265	126±4	100±2	150	63±2	160	8	M12	22	
160	FRN160F1□-4E	DCR4-160C	D	357±10	310	131±4	103±2	160	65.5±2	190	10	M12	25.5		
200	FRN200F1□-4E	DCR4-200C	D	357±10	310	141±4	113±2	165	70.5±2	190	10	M12	29.5		
220	FRN220F1□-4E	DCR4-220C	D	357±10	310	146±4	118±2	185	73±2	190	10	M12	32.5		
280	FRN280F1□-4E	DCR4-280C	D	350±10	310	161±4	133	210	80.5±2	190	M10	M16	36		
315	FRN315F1□-4E	DCR4-315C	D	400±10	345	146±4	118	200	73±2	225	M10	M16	40		
355	FRN355F1□-4E	DCR4-355C	E	400±10	345	156±4	128±2	200	78±2	225	M10	—	47		
400	FRN400F1□-4E	DCR4-400C	E	445±10	385	145±4	117	213	72.5±2	245	M10	—	52		
450	FRN450F1□-4E	DCR4-450C	E	440±10	385	150±4	122±2	215	75±2	245	M10	—	60		
500	FRN500F1□-4E	DCR4-500C	E	445±10	390	165±4	137±2	220	82.5±2	245	M10	—	70		
560	FRN560F1□-4E	DCR4-560C	F	270	145	208	170	200	—	480	φ14 long hole	φ15	70		

Note: Substitute "□" in the inverter model number with an alphabetic letter.

- S (Standard)
- E (EMC filter built-in type)
- H (DCR built-in type)
- B, D/L (Waterproof type)

Note: A DCR is standard for inverters of 75 kW or above, but optional for ones below 75 kW.

8.6.3 Models available on order

8.6.3.1 EMC filter built-in type

Unit: mm

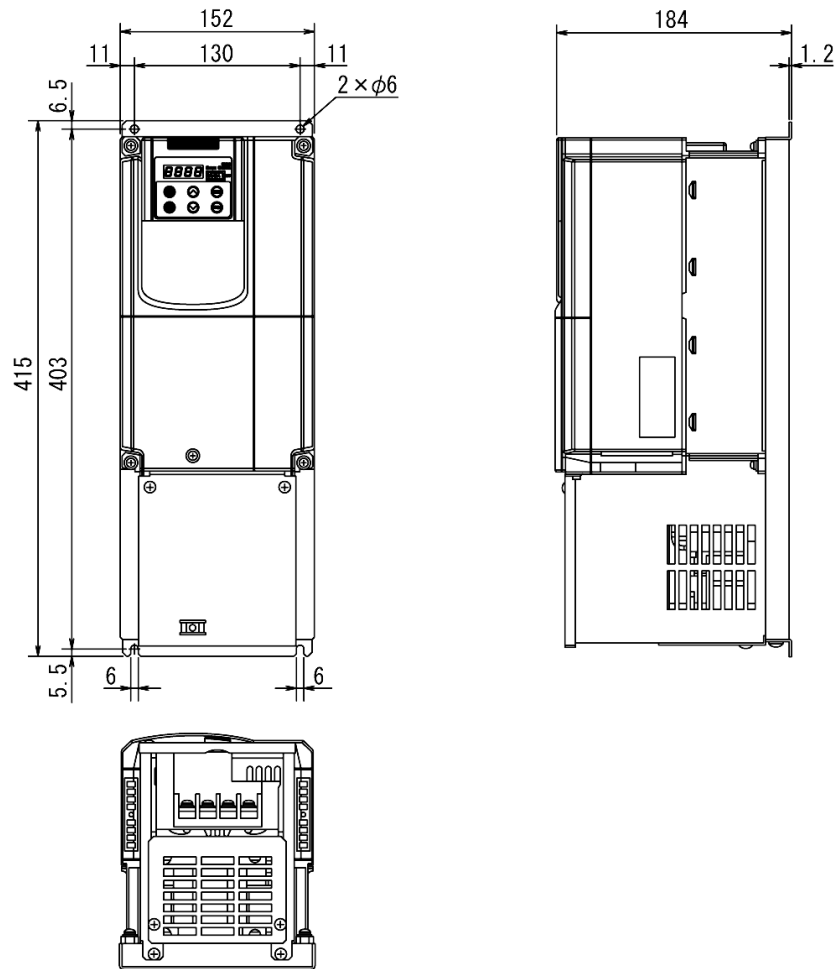

Power supply voltage	Inverter type
Three-phase 200 V	FRN0.75F1E-2E
	FRN1.5F1E-2E
	FRN2.2F1E-2E
	FRN3.7F1E-2E
	FRN5.5F1E-2E
Three-phase 400 V	FRN0.75F1E-4E
	FRN1.5F1E-4E
	FRN2.2F1E-4E
	FRN3.7F1E-4E
	FRN5.5F1E-4E

Unit: mm

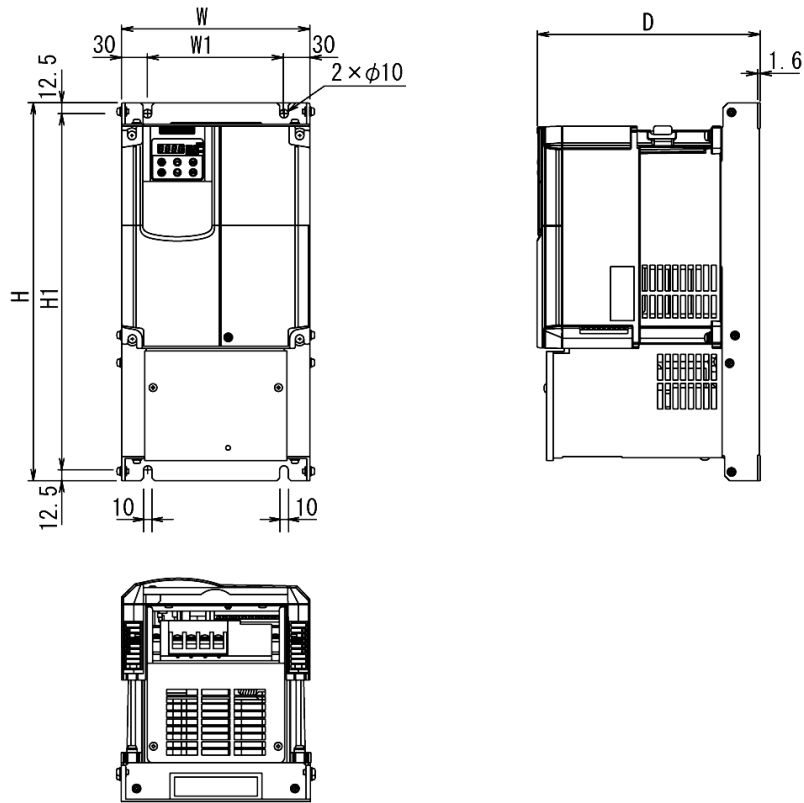

Power supply voltage	Inverter type	Dimension (mm)				
		W	W1	H	H1	D
Three-phase 200 V	FRN7.5F1E-2E	220	160	440	415	260
	FRN11F1E-2E					
	FRN15F1E-2E					
Three-phase 400 V	FRN7.5F1E-4E	220	160	440	415	260
	FRN11F1E-4E					
	FRN15F1E-4E					

8.6.3.2 Waterproof type (IP54)

Unit: mm

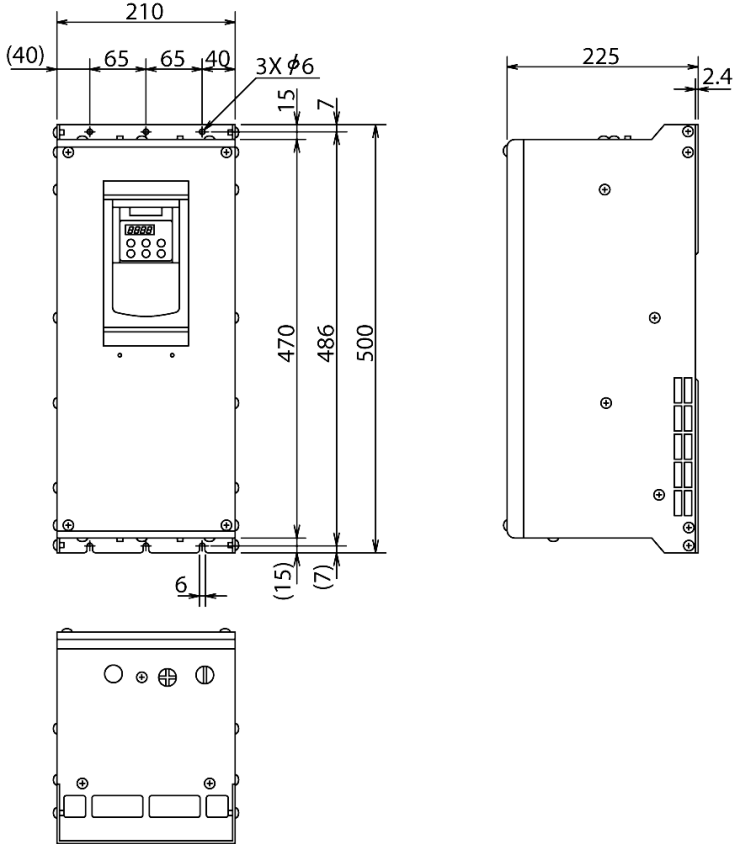

Power supply voltage	Inverter type
Three-phase 200 V	FRN0.75F1L-2E
	FRN1.5F1L-2E
	FRN2.2F1L-2E
	FRN3.7F1L-2E
	FRN5.5F1L-2E
Three-phase 400 V	FRN0.75F1L-4E
	FRN1.5F1L-4E
	FRN2.2F1L-4E
	FRN3.7F1L-4E
	FRN5.5F1L-4E

Unit: mm

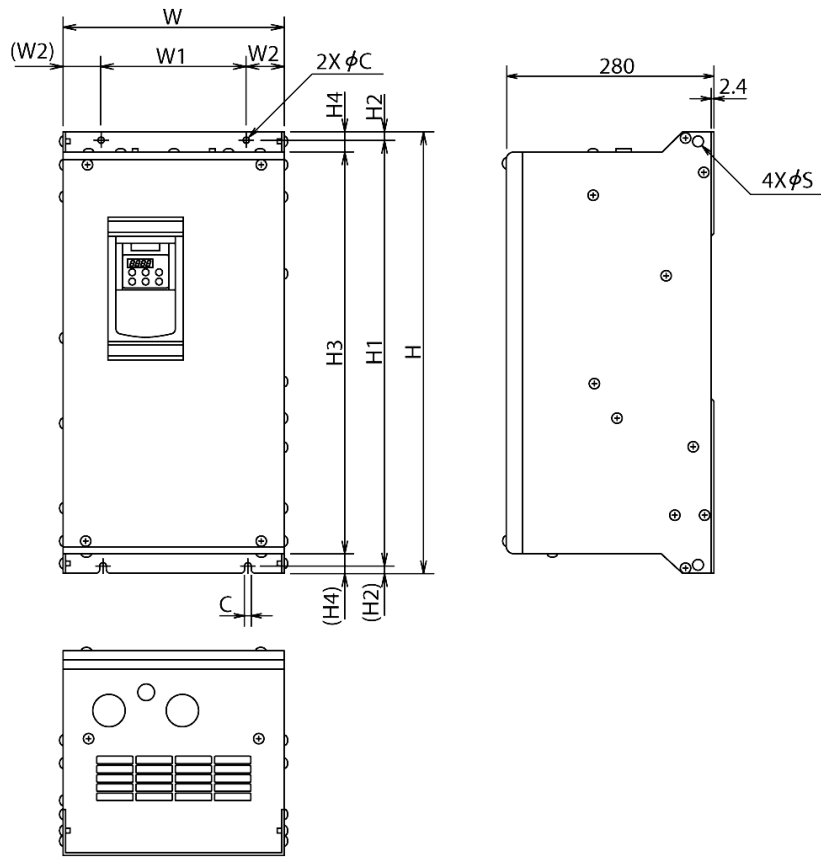

Power supply voltage	Inverter type	Dimension (mm)										
		W	W1	W2	H	H1	H2	H3	H4	D	C	S
Three-phase 200 V	FRN7.5F1B-2E	300	200	50	600	580	10	550	25	280	10	15
	FRN11F1B-2E											
	FRN15F1B-2E											
	FRN18.5F1D-2E	350	290	30	800	780	15	1030	35	320	15	18
	FRN22F1D-2E											
	FRN30F1D-2E											
	FRN37F1D-2E	400	360	20	1100	1073	15	1210	35	360	15	18
FRN45F1D-2E	450	400	25	1280	1250							
Three-phase 400 V	FRN7.5F1B-4E	300	200	50	600	580	10	550	25	280	10	15
	FRN11F1B-4E											
	FRN15F1B-4E											
	FRN18.5F1D-4E	350	290	30	800	780	15	1030	35	320	15	18
	FRN22F1D-4E											
	FRN30F1D-4E											
	FRN37F1D-4E	400	360	20	1100	1073	15	1100	35	350	15	18
	FRN45F1D-4E	450	400	25	1170	1140						
	FRN55F1D-4E	450	400	25	1280	1250	15	1210	35	360	15	18
	FRN75F1D-4E											
FRN90F1D-4E	450											

8.6.4 Standard keypad

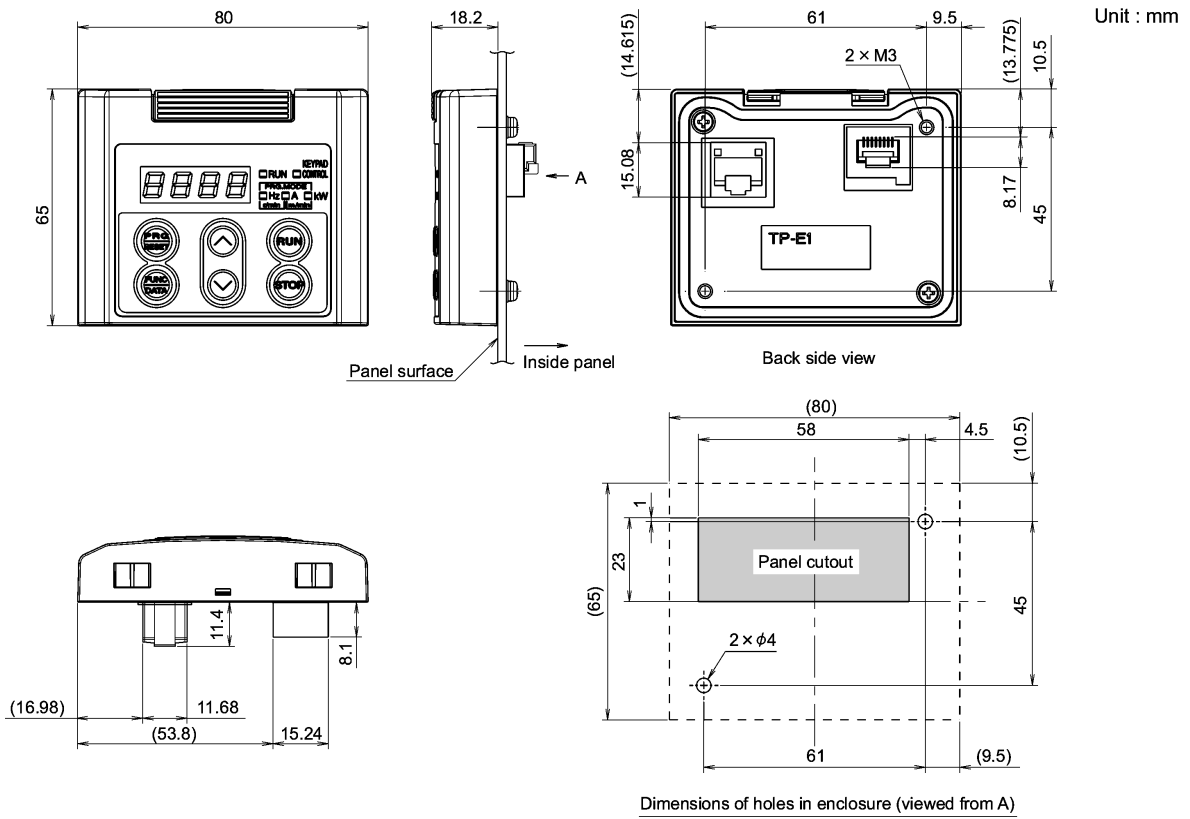

8.7 Connection Diagrams

8.7.1 Running the inverter with keypad

The diagram below shows a basic connection example for running the inverter with the keypad.

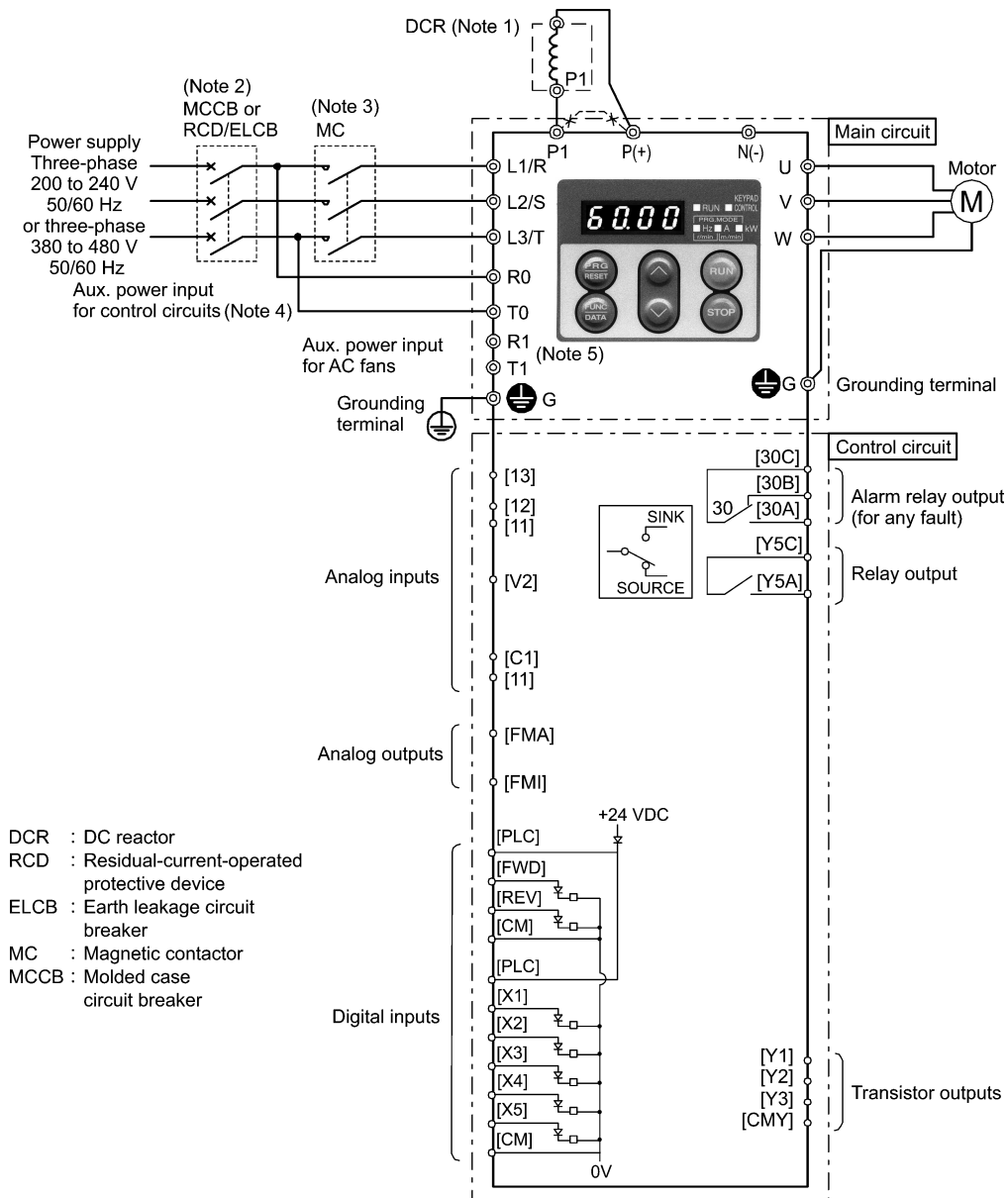

- (Note 1) When connecting a DC reactor (DCR), first remove the short bar between terminals [P1] and [P+]. A DCR is optional for inverters below 75 kW but standard for inverters of 75 kW or above. For inverters of 75 kW or above, be sure to connect a DCR.
- (Note 2) To protect wiring, insert a molded case circuit breaker (MCCB) or a residual-current-operated protective device (RCD)/earth leakage circuit breaker (ELCB) (with overcurrent protection) of the type recommended for the inverter between the commercial power supply and the inverter. Do not use a circuit breaker with a capacity exceeding the recommended capacity.
- (Note 3) In addition to an MCCB or RCD/ELCB, insert, if necessary, a magnetic contactor (MC) of the type recommended for the inverter to cut off the commercial power supply to the inverter. Furthermore, if the coil of the MC or solenoid comes into close contact with the inverter, install a surge absorber in parallel.
- (Note 4) To put the inverter on standby by making the control circuit only active with the main circuit power supply being opened, connect this pair of wires to terminals [R0] and [T0]. Without connecting this pair of wires to these terminals, you can still run the inverter as long as the main wires of the commercial power supply to the main circuit are properly connected.
- (Note 5) Normally no need to be connected. Use these terminals when the inverter is equipped with a high power factor PWM converter with a regenerative facility.

8.7.2 Running the inverter by terminal commands

The diagram below shows a basic connection example for running the inverter with terminal commands.

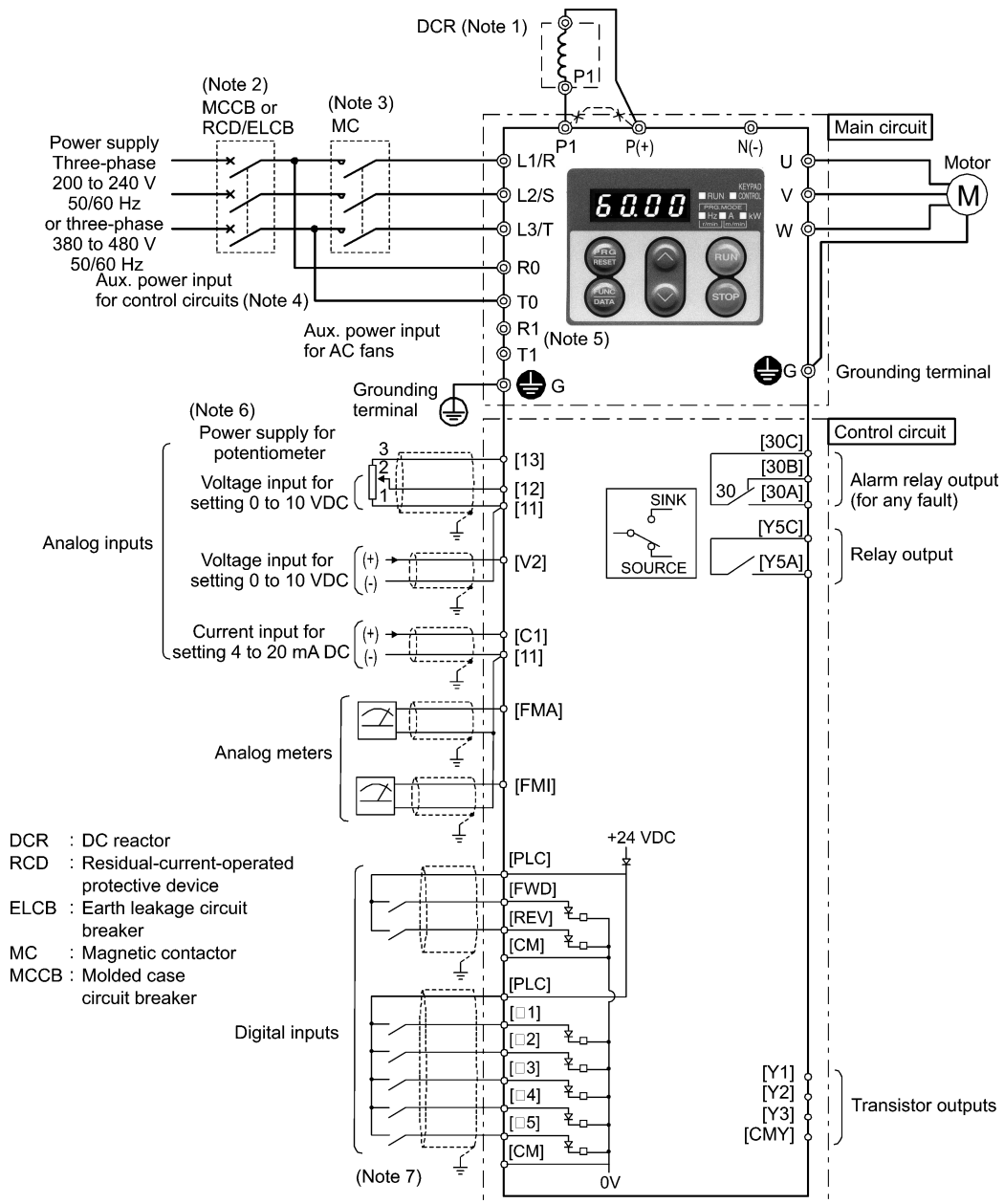

- (Note 1) When connecting a DC reactor (DCR), first remove the short bar between terminals [P1] and [P+]. A DCR is optional for inverters below 75 kW but standard for inverters of 75 kW or above. For inverters of 75 kW or above, be sure to connect a DCR.
- (Note 2) To protect wiring, insert a molded case circuit breaker (MCCB) or a residual-current-operated protective device (RCD)/earth leakage circuit breaker (ELCB) (with overcurrent protection) of the type recommended for the inverter between the commercial power supply and the inverter. Do not use a circuit breaker with a capacity exceeding the recommended capacity.
- (Note 3) In addition to an MCCB or RCD/ELCB, insert, if necessary, a magnetic contactor (MC) of the type recommended for the inverter to cut off the commercial power supply to the inverter. Furthermore, if the coil of the MC or solenoid comes into close contact with the inverter, install a surge absorber in parallel.
- (Note 4) To put the inverter on standby by making the control circuit only active with the main circuit power supply being opened, connect this pair of wires to terminals [R0] and [T0]. Without connecting this pair of wires to these terminals, you can still run the inverter as long as the main wires of the commercial power supply to the main circuit are properly connected.
- (Note 5) Normally no need to be connected. Use these terminals when the inverter is equipped with a high power factor PWM converter with a regenerative facility.
- (Note 6) You can select the frequency command source either electronically by supplying a DC voltage signal (within the range of 0 to 10 V, 0 to 5 V, or 1 to 5 V) between terminals [12] and [11], or manually by connecting a frequency command potentiometer to terminals [13], [12], and [11].
- (Note 7) For the wiring of the control circuit, use shielded or twisted wires. When using shielded wires, connect the shields to earth. To prevent malfunction due to noise, keep the control circuit wires as far away as possible from the main circuit wires (recommended distance: 10 cm or longer), and never put them in the same wire duct. Where a control circuit wire needs to cross a main circuit wire, route them so that they meet at right angles.

8.8 Protective Functions

The table below lists the name of the protective functions, description, alarm codes on the LED monitor, presence of alarm output at terminals [30A/B/C], and related function codes. If an alarm code appears on the LED monitor, remove the cause of activation of the alarm function referring to Chapter 10, "TROUBLESHOOTING."



Name	Description		LED monitor displays	Alarm output [30A/B/C]	Related function codes
Overcurrent protection	Stops the inverter output to protect the inverter from an overcurrent resulting from overload.	During acceleration	<i>OL1</i>	Yes	—
Short-circuit protection	Stops the inverter output to protect the inverter from overcurrent due to a short-circuiting in the output circuit.	During deceleration	<i>OL2</i>		
Ground fault protection	Stops the inverter output to protect the inverter from overcurrent due to a ground fault in the output circuit. This protection is effective only during startup of the inverter. If you turn ON the inverter without removing the ground fault, this protection may not work. (Applicable to inverters of 75 kW or below (3-phase 200 V) or 220 kW or below (3-phase 400 V))	During running at constant speed	<i>OL3</i>		
	Upon detection of zero-phase current in the output power, this function stops the inverter output to protect the inverter from overcurrent due to a ground fault in the output circuit. (Applicable to inverters of 90 kW or above (3-phase 200 V) or 280 kW or above (3-phase 400 V))		<i>EF</i>	Yes	
Overvoltage protection	The inverter stops the inverter output upon detection of an overvoltage condition (400 VDC for 3-phase 200 V, 800 VDC for 3-phase 400 V class series) in the DC link bus. This protection is not assured if extremely large AC line voltage is applied inadvertently.	During acceleration	<i>OU1</i>	Yes	
		During deceleration	<i>OU2</i>		
		During running at constant speed (Stopped)	<i>OU3</i>		
Undervoltage protection	Stops the inverter output when the DC link bus voltage drops below the undervoltage level (200 VDC for 3-phase 200 V, 400 VDC for 3-phase 400 V class series). However, if data "3, 4, or 5" is selected for F14, no alarm is output even if the DC link bus voltage drops.		<i>UV</i>	Yes*1	F14

"—": Not applicable

*1 This alarm on [30A/B/C] should be ignored depending upon the function code setting.

Name	Description	LED monitor displays	Alarm output [30A/B/C]	Related function codes
Input phase loss protection	<p>Detects input phase loss, stopping the inverter output. This function prevents the inverter from undergoing heavy stress that may be caused by input phase loss or inter-phase voltage unbalance and may damage the inverter.</p> <p>If connected load is light or a DC reactor is connected to the inverter, this function will not detect input phase loss if any.</p>	<i>L 117</i>	Yes	H98
Output phase loss protection	Detects breaks in inverter output wiring at the start of running and during running, stopping the inverter output.	<i>OPL</i>	Yes	
Overheat protection	<ul style="list-style-type: none"> - Stops the inverter output upon detecting excess heat sink temperature in case of cooling fan failure or overload. - Detects a failure of the internal air circulation DC fan and alarm-stops the inverter (For models of 45 kW or above in 200 V class series, 55 kW or above in 400 V class series) 	<i>OH 1</i>	Yes	H43
	Stops the inverter output upon detecting an excessively high ambient temperature inside the inverter caused by a failure or an overload condition of the cooling fan.	<i>OH3</i>	Yes	
Overload protection	Stops the inverter output if the Insulated Gate Bipolar Transistor (IGBT) internal temperature calculated from the output current and temperature of inside the inverter is over the preset value.	<i>OLU</i>	Yes	—
External alarm input	Places the inverter in alarm-stop state upon receiving digital input signal (THR).	<i>OH2</i>	Yes	E01-E05 E98, E99
Blown fuse	Upon detection of a fuse blown in the inverter's main circuit, this function stops the inverter output. (Applicable to 90 kW or above (for both 3-phase 200 V and 3-phase 400 V))	<i>FUS</i>	Yes	-
Abnormal condition in charger circuit	Upon detection of an abnormal condition in the charger circuit inside the inverter, this function stops the inverter output. (Applicable to 45 kW or above (3-phase 200 V) or 55 kW or above (3-phase 400 V))	<i>PLF</i>	Yes	-
Motor protection	<p>Electronic thermal overload</p> <p>In the following cases, the inverter stops running the motor to protect the motor in accordance with the electronic thermal overload protection setting.</p> <ul style="list-style-type: none"> - Protects general-purpose motors over the entire frequency range (F10 = 1.) - Protects inverter motors over the entire frequency range (F0 = 2.) <p>* The operation level and thermal time constant can be set by F11 and F12.</p>	<i>OL 1</i>	Yes	F10
				F11, F12

"—": Not applicable

Name		Description	LED monitor displays	Alarm output [30A/B/C]	Related function codes
Motor protection	PTC thermistor	A PTC thermistor input stops the inverter output for motor protection. Connect a PTC thermistor between terminals [V2] and [11] and set the function codes and slide switch on the control PCB accordingly.	$\overline{H4}$	Yes	H26, H27
	Overload early warning	Outputs a preliminary alarm at a preset level before the motor is stopped by the electronic thermal overload protection for the motor.	—	—	E34, E35
Stall prevention		Operates when instantaneous overcurrent limiting is active. - Instantaneous overcurrent limiting: Operates if the inverter's output current exceeds the instantaneous overcurrent limit level, avoiding tripping of the inverter (during constant speed operation or during acceleration).	—	—	H12
Alarm relay output (for any fault)		- The inverter outputs a relay contact signal when the inverter issues an alarm and stops the inverter output. < Alarm reset > The alarm stop state is reset by pressing the  key or by the digital input signal (RST). < Saving the alarm history and detailed data > The information on the previous 4 alarms can be saved and displayed.	—	Yes	E20, E27 E01-E05 E98, E99
Memory error detection		The inverter checks memory data after power-on and when the data is written. If a memory error is detected, the inverter stops.	$\overline{Er1}$	Yes	—
Keypad communications error detection		The inverter stops by detecting a communications error between the inverter and the keypad during operation using the standard keypad or the multi-function keypad (optional).	$\overline{Er2}$	Yes	F02
CPU error detection		If the inverter detects a CPU error or LSI error caused by noise or some other factors, this function stops the inverter.	$\overline{Er3}$	Yes	—
Option communications error detection		Upon detection of an error in the communication between the inverter and an optional card, stops the inverter output.	$\overline{Er4}$	—	—
Option error detection		When an option card has detected an error, this function stops the inverter output.	$\overline{Er5}$	—	—
Operation error detection	STOP key priority	Pressing the  key on the keypad forces the inverter to decelerate and stop the motor even if the inverter is running by any run commands given via the terminals or communications (link operation). After the motor stops, the inverter issues alarm $\overline{Er6}$.	$\overline{Er6}$	Yes	H96

"—": Not applicable

Name	Description		LED monitor displays	Alarm output [30A/B/C]	Related function codes
Operation error detection	Start check function	The inverter prohibits any run operations and displays $E-rE$ on the 7-segment LED monitor if any run command is present when: <ul style="list-style-type: none"> - Powering up - An alarm is released (the  key is turned ON or an alarm reset (RST) is input.) - "Enable communications link (LE)" has been activated and the run command is active in the linked source. 	$E-rE$	Yes	H96
Tuning error detection	During tuning of motor parameters, the tuning has failed or has aborted, or an abnormal condition has been detected in the tuning result, the inverter stops its output.		$E-r7$	Yes	P04
RS-485 communications error detection	When the inverter is connected to a communications network via the RS-485 port designed for the keypad, detecting a communications error stops the inverter output and displays an error code $E-rE$.		$E-rE$	Yes	—
Data save error during under-voltage	If the data could not be saved during activation of the undervoltage protection function, the inverter displays the alarm code.		$E-rF$	Yes	—
RS-485 communications error detection (optional)	When the inverter is connected to a communications network via an optional RS-485 communications card, detecting a communications error stops the inverter output and displays an error code $E-rP$.		$E-rP$	Yes	—
LSI error detection (Power PCB)	When an error occurred in the LSI on the power printed circuit board (power PCB), this function stops the inverter. (Applicable to: 200 V class series 45 kW or above, and 400 V class series 55 kW or above)		$E-rH$	Yes	—
Retry	When the inverter has stopped because of a trip, this function allows the inverter to automatically reset itself and restart. (You can specify the number of retries and the latency between stop and reset.)		—	—	H04, H05
Surge protection	Protects the inverter against surge voltages which might appear between one of the power lines for the main circuit and the ground.		—	—	—
Command loss detected	Upon detecting a loss of a frequency command (because of a broken wire, etc.), this function issues an alarm and continues the inverter operation at the preset reference frequency (specified as a ratio to the frequency just before the detection).		—	—	E65
Protection against momentary power failure	Upon detecting a momentary power failure lasting more than 15 msec, this function stops the inverter output.		—	—	F14
	If restart after momentary power failure is selected, this function invokes a restart process when power has been restored within a predetermined period.		—	—	H13-H16
Overload prevention control	In the event of overheating of the heat sink or an overload condition (alarm code: $OL1$ or $OL2$), the output frequency of the inverter is reduced to keep the inverter from tripping.		—	—	H70

"—": Not applicable

Chapter 9

FUNCTION CODES

This chapter contains overview lists of seven groups of function codes available for the FRENIC-Eco series of inverters and details of each function code.

Contents

9.1	Function Code Tables.....	9-1
9.2	Overview of Function Codes	9-22
9.2.1	F codes (Fundamental functions).....	9-22
9.2.2	E codes (Extension terminal functions)	9-51
9.2.3	C codes (Control functions of frequency).....	9-90
9.2.4	P codes (Motor parameters)	9-94
9.2.5	H codes (High performance functions).....	9-97
9.2.6	J codes (Application functions).....	9-119
9.2.7	y codes (Link functions).....	9-130

9.1 Function Code Tables

Function codes enable the FRENIC-Eco series of inverters to be set up to match your system requirements.









Each function code consists of a 3-letter alphanumeric string. The first letter is an alphabet that identifies its group and the following two letters are numerals that identify each individual code in the group. The function codes are classified into eight groups: Fundamental Functions (F codes), Extension Terminal Functions (E codes), Control Functions of Frequency (C codes), Motor Parameters (P codes), High Performance Functions (H codes), Application Functions (J codes), Link Functions (y codes) and Option Functions (o codes). To determine the property of each function code, set data to the function code.

This manual does not contain the descriptions of Option Function (o codes). For Option Function (o codes), refer to the instruction manual for each option.

The following descriptions supplement those given in the function code tables on page 9-3 and subsequent pages.

■ Changing, validating, and saving function code data when the inverter is running

Function codes are indicated by the following based on whether they can be changed or not when the inverter is running:

Notation	Change when running	Validating and saving function code data
Y*	Possible	If the data of the codes marked with Y* is changed with  and  keys, the change will immediately take effect; however, the change is not saved into the inverter's memory. To save the change, press the  key. If you press the  key without pressing the  key to exit the current state, then the changed data will be discarded and the previous data will take effect for the inverter operation.
Y	Possible	Even if the data of the codes marked with Y is changed with  and  keys, the change will not take effect. Pressing the  key will make the change take effect and save it into the inverter's memory.
N	Impossible	—

■ Copying data

The keypad is capable of copying of the function code data stored in the inverter's memory into the keypad's memory (refer to Menu #7 "Data copying" in Programming mode). With this feature, you can easily transfer the data saved in a source inverter to other destination inverters.

If the specifications of the source and destination inverters differ, some code data may not be copied to ensure safe operation of your power system. Whether data will be copied or not is detailed with the following symbols in the "Data copying" column of the function code tables given below.

Y: Will be copied unconditionally.

Y1: Will not be copied if the rated capacity differs from the source inverter.

Y2: Will not be copied if the rated input voltage differs from the source inverter.

N: Will not be copied. (The function code marked with "N" is not subject to the Verify operation, either.)

If necessary, set up uncopied code data manually and individually.

 For details of how to set up or edit function codes, refer to Chapter 3 "OPERATION USING THE KEYPAD."

 If you are using the multi-function keypad (option), refer to the Multi-function Keypad Instruction Manual (INR-SI47-0890-E) for details.

■ Using negative logic for programmable I/O terminals









The negative logic signaling system can be used for the digital input and output terminals by setting the function code data specifying the properties for those terminals. Negative logic refers to the inverted ON/OFF (logical value 1 (true)/0 (false)) state of input or output signal. An active ON signal (the function takes effect if the terminal is short-circuited.) in the normal logic system is functionally equivalent to active OFF signal (the function takes effect if the terminal is opened.) in the negative logic system. An active ON signal can be switched to active OFF signal, and vice versa, with the function code data setting.

To set the negative logic system for an I/O signal terminal, enter data of 1000s (by adding 1000 to the data for the normal logic) in the corresponding function code and then press the  key.

For example, if a coast-to-stop command (BX: data = 7) is assigned to any one of digital input terminals [X1] to [X5] by setting any of function codes E01 through E05, then turning (BX) on will make the motor coast to a stop. Similarly, if the coast-to-stop command (BX: data = 1007) is assigned, turning (BX) off will make the motor coast to a stop.

The following tables list the function codes available for the FRENIC-Eco series of inverters

F codes: Fundamental Functions

Code	Name	Data setting range	Increment	Unit	Change when running	Data copying	Default setting	Refer to page:
F00	Data Protection	0: Disable data protection (Function code data can be edited.) 1: Enable data protection	—	—	Y	Y	0	9-22
F01	Frequency Command 1	0: Enable  /  keys on keypad 1: Enable voltage input to terminal [12] (0 to 10 VDC) 2: Enable current input to terminal [C1] (4 to 20 mA DC) 3: Enable sum of voltage and current inputs to terminals [12] and [C1] 5: Enable voltage input to terminal [V2] (0 to 10 VDC) 7: Enable terminal command (UP) / (DOWN) control	—	—	N	Y	0	9-22 9-92
F02	Run Command	0: Enable  /  keys on keypad (Motor rotational direction from digital terminals [FWD] / [REV]) 1: Enable terminal command (FWD) or (REV) 2: Enable  /  keys on keypad (forward) 3: Enable  /  keys on keypad (reverse)	—	—	N	Y	2	9-23
F03	Maximum Frequency	25.0 to 120.0	0.1	Hz	N	Y	50	9-24
F04	Base Frequency	25.0 to 120.0	0.1	Hz	N	Y	50	9-25
F05	Rated Voltage at Base Frequency	0: Output a voltage in proportion to input voltage 80 to 240: Output a voltage AVR-controlled (for 200 V class series) 160 to 500: Output a voltage AVR-controlled (for 400 V class series)	1	V	N	Y2	400	9-112
F07	Acceleration Time 1	0.00 to 3600 Note: Entering 0.00 cancels the acceleration time, requiring external soft-start.	0.01	s	Y	Y	20.0	9-28
F08	Deceleration Time 1	0.00 to 3600 Note: Entering 0.00 cancels the deceleration time, requiring external soft-start.	0.01	s	Y	Y	20.0	

The shaded function codes () are applicable to the quick setup.

(F code continued)

Code	Name	Data setting range	Increment	Unit	Change when running	Data copying	Default setting	Refer to page:
F09	Torque Boost	0.0 to 20.0 (Percentage of the rated voltage at base frequency (F05)) Note: This setting is effective when F37 = 0, 1, 3, or 4.	0.1	%	Y	Y	Refer to table below.	9-28 9-49
F10	Electronic Thermal Overload Protection for Motor (Select motor characteristics)	1: For a general-purpose motor with shaft-driven cooling fan 2: For an inverter-driven motor, non-ventilated motor, or motor with separately powered cooling fan	—	—	Y	Y	1	9-31
F11	(Overload detection level)	0.00: Disable 1 to 135% of the rated current (allowable continuous drive current) of the motor	0.01	A	Y	Y1 Y2	100% of the motor rated current	
F12	(Thermal time constant)	0.5 to 75.0	0.1	min	Y	Y	5 (22 kW or below) 10 (30 kW or above)	
F14	Restart Mode after Momentary Power Failure (Mode selection)	0: Disable restart (Trip immediately) 1: Disable restart (Trip after a recovery from power failure) 3: Enable restart (Continue to run, for heavy inertia or general loads) 4: Enable restart (Restart at the frequency at which the power failure occurred, for general loads) 5: Enable restart (Restart at the starting frequency, for low-inertia load)	—	—	Y	Y	0	9-34 9-108 9-114
F15	Frequency Limiter (High)	0.0 to 120.0	0.1	Hz	Y	Y	70.0	9-41
F16	(Low)	0.0 to 120.0	0.1	Hz	Y	Y	0.0	9-41 9-112
F18	Bias (Frequency command 1)	-100.00 to 100.00 *1	0.01	%	Y*	Y	0.00	9-42 9-92 9-93
F20	DC Braking (Braking start frequency)	0.0 to 60.0	0.1	Hz	Y	Y	0.0	9-43 9-114
F21	(Braking level)	0 to 60 (Rated output current of the inverter interpreted as 100%)	1	%	Y	Y	0	9-43
F22	(Braking time)	0.00: Disable 0.01 to 30.00	0.01	s	Y	Y	0.00	
F23	Starting Frequency	0.1 to 60.0	0.1	Hz	Y	Y	0.5	9-45
F25	Stop Frequency	0.1 to 60.0	0.1	Hz	Y	Y	0.2	

The shaded function codes () are applicable to the quick setup.

*1 When you make settings from the keypad, the incremental unit is restricted by the number of digits that the LED monitor can display.

(Example) If the setting range is from -200.00 to 200.00, the incremental unit is:

"1" for -200 to -100, "0.1" for -99.9 to -10.0 and for 100.0 to 200.0, and "0.01" for -9.99 to -0.01 and for 0.00 to 99.99.

■ Torque boost per motor capacity by factory defaults (F09)

Motor rating (kW)	Torque boost (%)	Motor rating (kW)	Torque boost (%)
0.1	8.4	5.5	3.4
0.2	8.4	7.5	2.7
0.4	7.1	11	2.1
0.75	6.5	15	1.6
1.5	4.9	18.5	1.3
2.2	4.5	22	1.1
3.7	4.1	30 to 220	0.0

(F code continued)

Code	Name	Data setting range	Increment	Unit	Change when running	Data copying	Default setting	Refer to page:
F26	Motor Sound (Carrier frequency)	0.75 to 15 (22 kW or below) * ¹ 0.75 to 10 (30 to 75 kW) 0.75 to 6 (90 kW or above) 0.75 to 4 (37 to 90 kW, IP54 series)	1	kHz	Y	Y	(15/10/06)	9-45 9-115
F27	(Tone)	0: Level 0 (Inactive) 1: Level 1 2: Level 2 3: Level 3	—	—	Y	Y	0	9-45
F29	Analog Output [FMA] (Mode selection)	0: Output in voltage (0 to 10 VDC) 1: Output in current (4 to 20 mA DC)	—	—	Y	Y	0	9-46
F30	(Output adjustment)	0 to 200	1	%	Y*	Y	100	
F31	Analog Output [FMA] (Function)	Select a function to be monitored from the followings. 0: Output frequency 2: Output current 3: Output voltage 4: Output torque 5: Load factor 6: Input power 7: PID feedback value (PV) 9: DC link bus voltage 10: Universal AO 13: Motor output 14: Calibration 15: PID process command (SV) 16: PID process output (MV)	—	—	Y	Y	0	

The shaded function codes () are applicable to the quick setup.

*¹ If the carrier frequency is set at 1 kHz or below, estimate the maximum motor output torque at 80% or less of the rated motor torque.

(F code continued)

Code	Name	Data setting range	Increment	Unit	Change when running	Data copying	Default setting	Refer to page:
F34	Analog Output [FMI] (Duty)	0 to 200: Voltage output adjustment	1	%	Y*	Y	100	9-48
F35	(Function)	Select a function to be monitored from the followings. 0: Output frequency 2: Output current 3: Output voltage 4: Output torque 5: Load factor 6: Input power 7: PID feedback value (PV) 9: DC link bus voltage 10: Universal AO 13: Motor output 14: Calibration analog output (+) 15: PID process command (SV) 16: PID process output (MV)	—	—	Y	Y	0	
F37	Load Selection/ Auto Torque Boost / Auto Energy Saving Operation	0: Variable torque load 1: Variable torque load (Higher startup torque required) 2: Auto-torque boost 3: Auto-energy saving operation (Variable torque load) 4: Auto-energy saving operation (Variable torque load (Higher startup torque required)) Note: Apply this setting to a load with short acceleration time. 5: Auto-energy saving operation (Auto torque boost) Note: Apply this setting to a load with long acceleration time.	—	—	N	Y	1	9-28 9-49
F43	Current Limiter (Mode selection)	0: Disable (No current limiter works.) 1: Enable at constant speed (Disabled during acceleration and deceleration) 2: Enable during acceleration and at constant speed	—	—	Y	Y	0	9-49 9-107
F44	(Level)	20 to 120 (The data is interpreted as the rated output current of the inverter for 100%.)	1	%	Y	Y	110	

E codes: Extension Terminal Functions

Code	Name	Data setting range	Increment	Unit	Change when running	Data copying	Default setting	Refer to page:
E01	Command Assignment to:	Selecting function code data assigns the corresponding function to terminals [X1] to [X5] as listed below.	—	—	N	Y	6	9-51 9-89
E02	[X2]	Setting the value of 1000s in parentheses () shown below assigns a negative logic input to a terminal.	—	—	N	Y	7	
E03	[X3]	0 (1000): } Select multistep frequency (SS1)	—	—	N	Y	8	
E04	[X4]	1 (1001): } 2 (1002): } (SS2) (SS4)	—	—	N	Y	11	
E05	[X5]	6 (1006): Enable 3-wire operation (HLD) 7 (1007): Coast to a stop (BX) 8 (1008): Reset alarm (RST) 9 (1009): Enable external alarm trip (THR) 11 (1011): Switch frequency command 2/1 (Hz2/Hz1) 13: Enable DC brake (DCBRK) 15: Switch to commercial power (50 Hz) (SW50) 16: Switch to commercial power (60 Hz) (SW60) 17 (1017): UP (Increase output frequency) (UP) 18 (1018): DOWN (Decrease output frequency) (DOWN) 19 (1019): Enable write from keypad (Data changeable) (WE-KP) 20 (1020): Cancel PID control (Hz/PID) 21 (1021): Switch normal/inverse operation (IVS) 22 (1022): Interlock (IL) 24 (1024): Enable communications link via RS-485 or field bus (option) (LE) 25 (1025): Universal DI (U-DI) 26 (1026): Select starting characteristics (STM) 30 (1030): Force to stop (STOP) 33 (1033): Reset PID integral and differential components (PID-RST) 34 (1034): Hold PID integral component (PID-HLD) 35 (1035): Select local (keypad) operation (LOC) 38 (1038): Enable to run (RE) 39: Protect motor from dew condensation (DWP) 40: Enable integrated sequence to switch to commercial power (50 Hz) (ISW50) 41: Enable integrated sequence to switch to commercial power (60 Hz) (ISW60) 50 (1050): Clear periodic switching time (MCLR) 51 (1051): Enable pump drive (motor 1) (MEN1) 52 (1052): Enable pump drive (motor 2) (MEN2) 53 (1053): Enable pump drive (motor 3) (MEN3) 54 (1054): Enable pump drive (motor 4) (MEN4) 87 (1087): Switch run command 2/1 (FR2/FR1) 88: Run forward 2 (FWD2) 89: Run reverse 2 (REV2) Note: In the case of (THR) and (STOP), data (1009) and (1030) are for normal logic, and "9" and "30" are for negative logic, respectively.	—	—	N	Y	35	

(E code continued)

Code	Name	Data setting range	Increment	Unit	Change when running	Data copying	Default setting	Refer to page:
E20	Signal Assignment to: (Transistor signal) [Y1]	Selecting function code data assigns the corresponding function to terminals [Y1] to [Y3], [Y5A/C], and [30A/B/C] as listed below. Setting the value of 1000s in parentheses () shown below assigns a negative logic input to a terminal.	—	—	N	Y	0	9-73
E21	[Y2]		—	—	N	Y	1	
E22	[Y3]		—	—	N	Y	2	
E24	(Relay contact signal) [Y5A/C]	0 (1000): Inverter running (RUN) 1 (1001): Frequency arrival signal (FAR) 2 (1002): Frequency detected (FDT)	—	—	N	Y	10	
E27	[30A/B/C]	3 (1003): Undervoltage detected (Inverter stopped) (LU) 5 (1005): Inverter output limiting (IOL) 6 (1006): Auto-restarting after momentary power failure (IPF) 7 (1007): Motor overload early warning (OL) 10 (1010): Inverter ready to run (RDY) 11: Switch motor drive source between commercial power and inverter output (For MC on commercial line) (SW88) 12: Switch motor drive source between commercial power and inverter output (For secondary side) (SW52-2) 13: Switch motor drive source between commercial power and inverter output (For primary side) (SW52-1) 15 (1015): Select AX terminal function (For MC on primary side) (AX) 25 (1025): Cooling fan in operation (FAN) 26 (1026): Auto-resetting (TRY) 27 (1027): Universal DO (U-DO) 28 (1028): Heat sink overheat early warning (OH) 30 (1030): Service life alarm (LIFE) 33 (1033): Command loss detected (REF OFF) 35 (1035): Inverter output on (RUN2) 36 (1036): Overload prevention control (OLP) 37 (1037): Current detected (ID) 42 (1042): PID alarm (PID-ALM) 43 (1043): Under PID control (PID-CTL) 44 (1044): Motor stopping due to slow flowrate under PID control (PID-STP) 45 (1045): Low output torque detected (U-TL) 54 (1054): Inverter in remote operation (RMT) 55 (1055): Run command activated (AX2) 56 (1056): Motor overheat detected (PTC) (THM) 60 (1060): Mount motor 1, inverter-driven (M1_I) 61 (1061): Mount motor 1, commercial-power-driven (M1_L) 62 (1062): Mount motor 2, inverter-driven (M2_I) 63 (1063): Mount motor 2, commercial-power-driven (M2_L) 64 (1064): Mount motor 3, inverter-driven (M3_I) 65 (1065): Mount motor 3, commercial-power-driven (M3_L) 67 (1067): Mount motor 4, commercial-power-driven (M4_L) 68 (1068): Periodic switching early warning (MCHG) 69 (1069): Pump control limit signal (MLIM) 99 (1099): Alarm output (for any alarm) (ALM)	—	—	N	Y	99	

(E code continued)

Code	Name	Data setting range	Increment	Unit	Change when running	Data copying	Default setting	Refer to page:
E31	Frequency Detection (FDT) (Detection level)	0.0 to 120.0	0.1	Hz	Y	Y	50.0	9-80
E32	(Hysteresis width)	0.0 to 120.0	0.1	Hz	Y	Y	1.0	
E34	Overload Early Warning /Current Detection (Level)	0: (Disable) Current value of 1 to 150% of the inverter rated current	0.01	A	Y	Y1 Y2	100% of the motor rated current	
E35	(Timer)	0.01 to 600.00 * ¹	0.01	s	Y	Y	10.00	
E40	PID Display Coefficient A	-999 to 0.00 to 999 * ¹	0.01	—	Y	Y	100	
E41	PID Display Coefficient B	-999 to 0.00 to 999 * ¹	0.01	—	Y	Y	0.00	
E43	LED Monitor (Item selection)	0: Speed monitor (Select by E48.) 3: Output current 4: Output voltage 8: Calculated torque 9: Input power 10: PID process command (Final) 12: PID feedback value 14: PID output 15: Load factor 16: Motor output 17: Analog input	—	—	Y	Y	0	9-83 9-85
E45	LCD Monitor * ² (Item selection)	0: Running status, rotational direction and operation guide 1: Bar charts for output frequency, current and calculated torque	—	—	Y	Y	0	9-84
E46	(Language selection)	0: Japanese 1: English 2: German 3: French 4: Spanish 5: Italian	—	—	Y	Y	1	9-85
E47	(Contrast control)	0 (Low) to 10 (High)	1	—	Y	Y	5	
E48	LED Monitor (Speed monitor item)	0: Output frequency 3: Motor speed in r/min 4: Load shaft speed in r/min 7: Display speed in %	—	—	Y	Y	0	9-83 9-85
E50	Coefficient for Speed Indication	0.01 to 200.00 * ¹	0.01	—	Y	Y	30.00	9-85
E51	Display Coefficient for Input Watt-hour Data	0.000: (Cancel/reset) 0.001 to 9999	0.001	—	Y	Y	0.010	
E52	Keypad (Menu display mode)	0: Function code data editing mode (Menus #0, #1 and #7) 1: Function code data check mode (Menus #2 and #7) 2: Full-menu mode (Menus #0 through #7)	—	—	Y	Y	0	9-86

The shaded function codes () are applicable to the quick setup.

*¹ When you make settings from the keypad, the incremental unit is restricted by the number of digits that the LED monitor can display.

(Example) If the setting range is from -200.00 to 200.00, the incremental unit is:

"1" for -200 to -100, "0.1" for -99.9 to -10.0 and for 100.0 to 200.0, and "0.01" for -9.99 to -0.01 and for 0.00 to 99.99.

*² LCD monitor settings are applicable only to the inverter equipped with a multi-function keypad.

(E code continued)

Code	Name	Data setting range	Increment	Unit	Change when running	Data copying	Default setting	Refer to page:
E61	Analog Input for: (Extension function selection)	Selecting function code data assigns the corresponding function to terminals [12], [C1] and [V2] as listed below. 0: None 1: Auxiliary frequency command 1 2: Auxiliary frequency command 2	—	—	N	Y	0	9-87
E62	[12]	3: PID process command 1 5: PID feedback value	—	—	N	Y	0	
E63	[V2]	20: Analog input monitor	—	—	N	Y	0	
E64	Saving Digital Reference Frequency	0: Auto saving (at the time of main power turned off) 1: Saving by pressing  key	—	—	Y	Y	0	
E65	Command Loss Detection (Level)	0: Decelerate to stop 20 to 120 999: Disable	1	%	Y	Y	999	9-88
E80	Detect Low Torque (Detection level)	0 to 150	1	%	Y	Y	20	9-89
E81	(Timer)	0.01 to 600.00 *1	0.01	s	Y	Y	20.00	

*1 When you make settings from the keypad, the incremental unit is restricted by the number of digits that the LED monitor can display.



(Example) If the setting range is from -200.00 to 200.00, the incremental unit is:

"1" for -200 to -100, "0.1" for -99.9 to -10.0 and for 100.0 to 200.0, and "0.01" for -9.99 to -0.01 and for 0.00 to 99.99.

(E code continued)

Code	Name	Data setting range	Increment	Unit	Change when running	Data copying	Default setting	Refer to page:
E98	Command Assignment to: [FWD]	Selecting function code data assigns the corresponding function to terminals [FWD] and [REV] as listed below.	—	—	N	Y	98	9-51 9-89
E99	[REV]	Setting the value of 1000s in parentheses () shown below assigns a negative logic input to a terminal. 0 (1000): } (SS1) 1 (1001): } Select multistep frequency (SS2) 2 (1002): } (SS4) 6 (1006): Enable 3-wire operation (HLD) 7 (1007): Coast to a stop (BX) 8 (1008): Reset alarm (RST) 9 (1009): Enable external alarm trip (THR) 11 (1011): Switch frequency command 2/1 (Hz2/Hz1) 13: Enable DC brake (DCBRK) 15: Switch to commercial power (50 Hz) (SW50) 16: Switch to commercial power (60 Hz) (SW60) 17 (1017): UP (Increase output frequency) (UP) 18 (1018): DOWN (Decrease output frequency) (DOWN) 19 (1019): Enable write from keypad (Data changeable) 20 (1020): Cancel PID control (Hz/PID) 21 (1021): Switch normal/inverse operation (IVS) 22 (1022): Interlock (IL) 24 (1024): Enable communications link via RS-485 or field bus (option) (LE) 25 (1025): Universal DI (U-DI) 26 (1026): Select starting characteristics (STM) 30 (1030): Force to stop (STOP) 33 (1033): Reset PID integral and differential components (PID-RST) 34 (1034): Hold PID integral component (PID-HLD) 35 (1035): Select local (keypad) operation (LOC) 38 (1038): Enable to run (RE) 39: Protect motor from dew condensation (DWP) 40: Enable integrated sequence to switch to commercial power (50 Hz) (ISW50) 41: Enable integrated sequence to switch to commercial power (60 Hz) (ISW60) 50 (1050): Clear periodic switching time (MCLR) 51 (1051): Enable pump drive (motor 1) (MEN1) 52 (1052): Enable pump drive (motor 2) (MEN2) 53 (1053): Enable pump drive (motor 3) (MEN3) 54 (1054): Enable pump drive (motor 4) (MEN4) 87 (1087): Switch run command 2/1 (FR2/FR1) 88: Run forward 2 (FWD2) 89: Run reverse 2 (REV2) 98: Run forward (FWD) 99: Run reverse (REV) Note: In the case of (THR) and (STOP), data (1009) and (1030) are for normal logic, and "9" and "30" are for negative logic, respectively.	—	—	N	Y	99	

C codes: Control Functions of Frequency

Code	Name	Data setting range	Increment	Unit	Change when running	Data copying	Default setting	Refer to page:
C01	Jump Frequency 1	0.0 to 120.0	0.1	Hz	Y	Y	0.0	9-90
C02	2				Y	Y	0.0	
C03	3				Y	Y	0.0	
C04	(Band)	0.0 to 30.0	0.1	Hz	Y	Y	0.0	
C05	Multistep Frequency 1	0.00 to 120.00 * ¹	0.01	Hz	Y	Y	0.00	9-91
C06	2				Y	Y	0.00	
C07	3				Y	Y	0.00	
C08	4				Y	Y	0.00	
C09	5				Y	Y	0.00	
C10	6				Y	Y	0.00	
C11	7				Y	Y	0.00	
C30	Frequency Command 2	0: Enable  /  keys on keypad 1: Enable voltage input to terminal [12] (0 to 10 VDC) 2: Enable current input to terminal [C1] (4 to 20 mA DC) 3: Enable sum of voltage and current inputs to terminals [12] and [C1] 5: Enable voltage input to terminal [V2] (0 to 10 VDC) 7: Enable terminal command (UP) / (DOWN) control	—	—	N	Y	2	9-22 9-92
C32	Analog Input Adjustment for [12] (Gain)	0.00 to 200.00 * ¹	0.01	%	Y*	Y	100.0	9-42 9-92
C33	(Filter time constant)	0.00 to 5.00	0.01	s	Y	Y	0.05	9-93
C34	(Gain reference point)	0.00 to 100.00 * ¹	0.01	%	Y*	Y	100.0	9-42 9-92
C37	Analog Input Adjustment for [C1] (Gain)	0.00 to 200.00 * ¹	0.01	%	Y*	Y	100.0	
C38	(Filter time constant)	0.00 to 5.00	0.01	s	Y	Y	0.05	9-93
C39	(Gain reference point)	0.00 to 100.00 * ¹	0.01	%	Y*	Y	100.0	9-42 9-92
C42	Analog Input Adjustment for [V2] (Gain)	0.00 to 200.00 * ¹	0.01	%	Y*	Y	100.0	
C43	(Filter time constant)	0.00 to 5.00	0.01	s	Y	Y	0.05	9-93
C44	(Gain reference point)	0.00 to 100.00 * ¹	0.01	%	Y*	Y	100.0	9-42 9-92
C50	Bias Reference Point (Frequency command 1)	0.00 to 100.0 * ¹	0.01	%	Y*	Y	0.00	9-42 9-93
C51	Bias for PID command 1 (Bias value)	-100.0 to 100.00 * ¹	0.01	%	Y*	Y	0.00	9-93
C52	(Bias reference point)	0.00 to 100.00 * ¹	0.01	%	Y*	Y	0.00	
C53	Selection of Normal/ Inverse Operation (Frequency command 1)	0: Normal operation 1: Inverse operation	—	—	Y	Y	0	

*¹ When you make settings from the keypad, the incremental unit is restricted by the number of digits that the LED monitor can display.

(Example) If the setting range is from -200.00 to 200.00, the incremental unit is:

"1" for -200 to -100, "0.1" for -99.9 to -10.0 and for 100.0 to 200.0, and "0.01" for -9.99 to -0.01 and for 0.00 to 99.99.

P codes: Motor Parameters

Code	Name	Data setting range	Incre- ment	Unit	Change when running	Data copying	Default setting	Refer to page:
P01	Motor (No. of poles)	2 to 22	2	Pole	N	Y1 Y2	4	9-94
P02	(Rated capacity)	0.01 to 1000 (where, the data of function code P99 is 0, 3, or 4.) 0.01 to 1000 (where, the data of function code P99 is 1.)	0.01	kW HP	N	Y1 Y2	Rated capacity of motor	
P03	(Rated current)	0.00 to 2000	0.01	A	N	Y1 Y2	Rated current of Fuji standard motor	
P04	(Auto-tuning)	0: Disable 1: Enable (Tune %R1 and %X while the motor is stopped.) 2: Enable (Tune %R1 and %X while the motor is stopped, and no-load current while running.)	—	—	N	N	0	
P06	(No-load current)	0.00 to 2000	0.01	A	N	Y1 Y2	Rated value of Fuji standard motor	9-95
P07	(%R1)	0.00 to 50.00	0.01	%	Y	Y1 Y2	Rated value of Fuji standard motor	
P08	(%X)	0.00 to 50.00	0.01	%	Y	Y1 Y2	Rated value of Fuji standard motor	
P99	Motor Selection	0: Characteristics of motor 0 (Fuji standard motors, 8-series) 1: Characteristics of motor 1 (HP rating motors) 3: Characteristics of motor 3 (Fuji standard motors, 6-series) 4: Other motors	—	—	N	Y1 Y2	0	9-96

The shaded function codes () are applicable to the quick setup.

H codes: High Performance Functions

Code	Name	Data setting range	Increment	Unit	Change when running	Data copying	Default setting	Refer to page:
H03	Data Initialization	0: Disable initialization 1: Initialize all function code data to the factory defaults 2: Initialize motor parameters	—	—	N	N	0	9-97
H04	Auto-resetting (Times)	0: Disable 1 to 10	1	Times	Y	Y	0	9-101
H05	(Reset interval)	0.5 to 20.0	0.1	s	Y	Y	5.0	
H06	Cooling Fan ON/OFF Control	0: Disable (Always in operation) 1: Enable (ON/OFF controllable)	—	—	Y	Y	0	9-102
H07	Acceleration/Deceleration Pattern	0: Linear 1: S-curve (Weak) 2: S-curve (Strong) 3: Curvilinear	—	—	Y	Y	0	9-103
H09	Select Starting Characteristics (Auto search for idling motor's speed)	0: Disable 3: Enable (Follow Run command, either forward or reverse.) 4: Enable (Follow Run command, both forward and reverse.) 5: Enable (Follow Run command, inversely both forward and reverse.)	—	—	N	Y	0	9-105 9-108
H11	Deceleration Mode	0: Normal deceleration 1: Coast-to-stop	—	—	Y	Y	0	9-107
H12	Instantaneous Overcurrent Limiting	0: Disable 1: Enable	—	—	Y	Y	1	
H13	Restart Mode after Momentary Power Failure (Restart time)	0.1 to 10.0	0.1	s	Y	Y1 Y2	Depending on the inverter capacity	9-34 9-108
H14	(Frequency fall rate)	0.00: Set deceleration time 0.01 to 100.00 999: Follow the current limit command	0.01	Hz/s	Y	Y		
H15	(Continuous running level)	200 V class series: 200 to 300 400 V class series: 400 to 600	1	V	Y	Y2	235 470	9-108
H16	(Allowable momentary power failure time)	0.0 to 30.0 999: The longest time automatically determined by the inverter	0.1	s	Y	Y	999	
H17	Select Starting Characteristics (Frequency for idling motor's speed)	0.0 to 120.0 999: Harmonize at the maximum frequency	0.1	Hz	Y	Y	999	9-28 9-108
H26	PTC Thermistor (Mode selection)	0: Disable 1: Enable (Upon detection of (PTC), the inverter immediately trips and stops with $\overline{H-L}$ displayed.) 2: Enable (Upon detection of (PTC), the inverter continues running while outputting alarm signal (THM).)	—	—	Y	Y	0	9-108
H27	(Level)	0.00 to 5.00	0.01	V	Y	Y	1.60	

(H code continued)

Code	Name	Data setting range	Incre- ment	Unit	Change when running	Data copying	Default setting	Refer to page:
H30	Communications Link Function (Mode selection)	Frequency command Run command 0: F01/C30 F02 1: RS-485 link F02 2: F01/C30 RS-485 link 3: RS-485 link RS-485 link 4: RS-485 link (Option) F02 5: RS-485 link (Option) RS-485 link 6: F01/C30 RS-485 link (Option) 7: RS-485 link RS-485 link (Option) 8: RS-485 link (Option) RS-485 link (Option)	—	—	Y	Y	0	9-110 9-133
H42	Capacitance of DC Link Bus Capacitor	Indication for replacing DC link bus capacitor (0000 to FFFF: Hexadecimal)	1	—	Y	N	—	9-111
H43	Cumulative Run Time of Cooling Fan	Indication of cumulative run time of cooling fan for replacement	—	—	Y	N	—	
H47	Initial Capacitance of DC Link Bus Capacitor	Indication for replacing DC link bus capacitor (0000 to FFFF: Hexadecimal)	—	—	Y	N	Set at factory shipping	
H48	Cumulative Run Time of Capacitors on the Printed Circuit Board	Indication for replacing capacitors on printed circuit board (0000 to FFFF: Hexadecimal). Resettable.	—	—	Y	N	—	
H49	Select Starting Characteristics (Auto search time for idling motor's speed)	0.0 to 10.0	0.1	s	Y	Y	0.0	9-112
H50	Non-linear V/f Pattern (Frequency)	0.0: Cancel 0.1 to 120.0	0.1	Hz	N	Y	0.0 (22 kW or below) 5.0 (30 kW or above)	9-25 9-112
H51	(Voltage)	0 to 240: Output a voltage AVR-controlled (for 200 V class series) 0 to 500: Output a voltage AVR-controlled (for 400 V class series)	1	V	N	Y2	0 (22 kW or below) 20 (30 kW or above for 200 V class series) 40 (30 kW or above for 400 V class series)	
H56	Deceleration Time for Forced Stop	0.00 to 3600	0.01	s	Y	Y	20.0	9-112
H63	Low Limiter (Mode selection)	0: Limit by F16 (Frequency Limiter: Low) and continue to run 1: If the output frequency lowers less than the one limited by F16 (Frequency Limiter: Low), decelerates to stop the motor.	—	—	Y	Y	0	9-41 9-112
H64	(Lower limiting frequency)	0.0 (Depends on F16 (Frequency Limiter: Low)) 0.1 to 60.0	0.1	Hz	Y	Y	2.0	9-112
H69	Automatic Deceleration	0: Disable 3: Enable (Control DC link bus voltage at a constant.)	—	—	Y	Y	0	
H70	Overload Prevention Control	0.00: Follow deceleration time specified by F08 0.01 to 100.00 999: Disable	0.01	Hz/s	Y	Y	999	9-113
H71	Deceleration Characteristics	0: Disable 1: Enable	—	—	Y	Y	0	

(H code continued)

Code	Name	Data setting range	Increment	Unit	Change when running	Data copying	Default setting	Refer to page:		
H80	Gain for Suppression of Output Current Fluctuation for Motor	0.00 to 0.40	0.01	—	Y	Y	^{*3} Depend- ing on the inverter capacity	9-113		
H86	Reserved. ^{*2}	0 to 2	1	—	Y	Y1 Y2	^{*4} Depend- ing on the inverter capacity	—		
H87	Reserved. ^{*2}	25.0 to 120.0	0.1	Hz	Y	Y	25.0			
H88	Reserved. ^{*2}	0 to 3, 999	1	—	Y	N	0			
H89	Reserved. ^{*2}	0, 1	—	—	Y	Y	0			
H90	Reserved. ^{*2}	0, 1	—	—	Y	Y	0			
H91	Terminal [C1] Wire Break Detection	0.0: Disable wire break protection 0.1 to 60.0: Wire break detection time	0.1	s	Y	Y	0.0			
H92	Continue to Run (P-component: gain)	0.000 to 10.000, 999 ^{*1}	0.001	Times	Y	Y1 Y2	999	9-34 9-114		
H93	(I-component: time)	0.010 to 10.000, 999 ^{*1}	0.001	s	Y	Y1 Y2	999	9-41 9-114		
H94	Cumulative Run Time of Motor	Change or reset the cumulative data	—	—	N	N	—	9-114		
H95	DC Braking (Braking response mode)	0: Slow 1: Quick	—	—	Y	Y	1	9-43 9-114		
H96	STOP Key Priority/ Start Check Function	Data	STOP key priority	Start check function	—	—	Y	Y	0	9-114
		0:	Disable	Disable						
		1:	Enable	Disable						
		2:	Disable	Enable						
		3:	Enable	Enable						
H97	Clear Alarm Data	Setting H97 data to "1" clears alarm data and then returns to zero.	—	—	Y	N	0	9-115		
H98	Protection/ Maintenance Function	0 to 63: Display data on the keypad's LED monitor in decimal format (In each bit, "0" for disabled, "1" for enabled.) Bit 0: Lower the carrier frequency automatically Bit 1: Detect input phase loss Bit 2: Detect output phase loss Bit 3: Select life judgment criteria of DC link bus capacitor Bit 4: Judge the life of DC link bus capacitor Bit 5: Detect DC fan lock	—	—	Y	Y	19 (Bits 4, 1, 0 = 1 Bits 5, 3, 2 = 0)	9-45 9-115		

^{*1} When you make settings from the keypad, the incremental unit is restricted by the number of digits that the LED monitor can display.

(Example) If the setting range is from -200.00 to 200.00, the incremental unit is:

"1" for -200 to -100, "0.1" for -99.9 to -10.0 and for 100.0 to 200.0, and "0.01" for -9.99 to -0.01 and for 0.00 to 99.99.

^{*2} The H86 through H91 are displayed, but they are reserved for particular manufacturers. Unless otherwise specified, do not access these function codes.

^{*3} Select 0.10 for models of 45 kW or above (200 V class series) and 55 kW or above (400 V class series), 0.20 for models of 37 kW or below (200 V class series) and 45 kW or below (400 V class series).

^{*4} Select 2 for models of 45 kW or above (200 V class series) and 55 kW or above (400 V class series), 0 for models of 37 kW or below (200 V class series) and 45 kW or below (400 V class series).

J codes: Application Functions

Code	Name	Data setting range	Increment	Unit	Change when running	Data copying	Default setting	Refer to page:
J01	PID Control (Mode selection)	0: Disable 1: Enable (normal operation) 2: Enable (inverse operation)	—	—	N	Y	0	9-119
J02	(Remote process command)	0: Enable \odot / \ominus keys on keypad 1: PID process command 1 3: Enable terminal command (UP) / (DOWN) control 4: Command via communications link	—	—	N	Y	0	
J03	P (Gain)	0.000 to 30.000 * ¹	0.001	Times	Y	Y	0.100	
J04	I (Integral time)	0.0 to 3600.0 * ¹	0.1	s	Y	Y	0.0	
J05	D (Differential time)	0.00 to 600.00 * ¹	0.01	s	Y	Y	0.00	
J06	(Feedback filter)	0.0 to 900.0	0.1	s	Y	Y	0.5	
J10	(Anti reset windup)	0 to 200	1	%	Y	Y	200	9-125
J11	(Select alarm output)	0: Absolute-value alarm 1: Absolute-value alarm (with Hold) 2: Absolute-value alarm (with Latch) 3: Absolute-value alarm (with Hold and Latch) 4: Deviation alarm 5: Deviation alarm (with Hold) 6: Deviation alarm (with Latch) 7: Deviation alarm (with Hold and Latch)	—	—	Y	Y	0	9-126
J12	(Upper limit alarm (AH))	0 to 100	1	%	Y	Y	100	
J13	(Lower limit alarm (AL))	0 to 100	1	%	Y	Y	0	
J15	(Stop frequency for slow flowrate)	0: Disable 1 to 120	1	Hz	Y	Y	0	9-127
J16	(Slow flowrate level stop latency)	1 to 60	1	s	Y	Y	30	
J17	(Starting frequency)	0: Disable 1 to 120	1	Hz	Y	Y	0	
J18	(Upper limit of PID process output)	1 to 120 999: Depends on setting of F15	1	Hz	Y	Y	999	9-128
J19	(Lower limit of PID process output)	1 to 120 999: Depends on setting of F16	1	Hz	Y	Y	999	
J21	Dew Condensation Prevention (Duty)	1 to 50	1	%	Y	Y	1	9-129
J22	Commercial Power Switching Sequence	0: Keep inverter operation (Stop due to alarm) 1: Automatically switch to commercial-power operation	—	—	N	Y	0	9-51 9-129

*¹ When you make settings from the keypad, the incremental unit is restricted by the number of digits that the LED monitor can display.

(Example) If the setting range is from -200.00 to 200.00, the incremental unit is:

"1" for -200 to -100, "0.1" for -99.9 to -10.0 and for 100.0 to 200.0, and "0.01" for -9.99 to -0.01 and for 0.00 to 99.99.

(J code continued)

Code	Name	Data setting range	Increment	Unit	Change when running	Data copying	Default setting	Refer to page:
J25	Pump Control (Mode selection)	0: Disable 1: Enable (Fixed, inverter-driven) 2: Enable (Floating, inverter-driven)	—	—	N	Y	0	—
J26	Motor 1 Mode	0: Disable (Always OFF) 1: Enable 2: Force to run by commercial power	—	—	Y	Y	0	
J27	Motor 2 Mode		—	—	Y	Y	0	
J28	Motor 3 Mode		—	—	Y	Y	0	
J29	Motor 4 Mode		—	—	Y	Y	0	
J30	Motor Switching Order		0: Fixed 1: Automatically (Constant run time)	—	—	N	Y	0
J31	Motor Stop Mode	0: Stop all motors (inverter- and commercial power-driven) 1: Stop inverter-driven motor only (excl. alarm state) 2: Stop inverter-driven motor only (incl. alarm state)	—	—	N	Y	0	
J32	Periodic Switching Time for Motor Drive	0.0: Disable switching 0.1 to 720.0: Switching time range 999: Fix to 3 minutes	0.1	h	N	Y	0.0	
J33	Periodic Switching Signaling Period	0.00 to 600.00	0.01	s	Y	Y	0.1	
J34	Mount of Commercial Power-driven Motor (Frequency)	0 to 120 999: Depends on setting of J18 (This code is used to judge whether or not to mount a commercial power-driven motor by checking the output frequency of the inverter-driven motor.)	1	Hz	Y	Y	999	
J35	(Duration)	0.00 to 3600	Variable	s	Y	Y	0	
J36	Unmount of Commercial Power-driven Motor (Frequency)	0 to 120 999: Depends on setting of J19 (This code is used to judge whether or not to unmount a commercial power-driven motor by checking the output frequency of the inverter-driven motor.)	1	Hz	Y	Y	999	
J37	(Duration)	0.00 to 3600	Variable	s	Y	Y	0	
J38	Contacting Delay Time	0.01 to 2.00	0.01	s	Y	Y	0.01	
J39	Switching Time for Motor Mount (Decl. time)	0.00: Depends on the setting of F08, 0.01 to 3600	Variable	s	Y	Y	0.00	
J40	Switching Time for Motor Unmount (Accl. time)	0.00: Depends on the setting of F07, 0.01 to 3600	Variable	s	Y	Y	0.00	
J41	Motor Mount/Unmount Switching Level	0 to 100	1	%	Y	Y	0	
J42	Switching Motor Mount/Unmount (Dead band)	0.0: Disable 0.1 to 50.0	0.1	%	Y	Y	0.0	

(J code continued)

Code	Name	Data setting range	Increment	Unit	Change when running	Data copying	Default setting	Refer to page:
J43	PID Control Startup Frequency	0: Disable 1 to 120 999: Depends on the setting of J36	1	Hz	Y	Y	999	—
J45	Signal Assignment to: (For relay output card)	Selecting function code data assigns the corresponding function to terminals [Y1A/B/C], [Y2A/B/C], and [Y3A/B/C].	—	—	N	Y	100	
J46	[Y1A/B/C]	100: Depends on the setting of E20 to E22 60 (1060): Mount motor 1, inverter-driven (M1_I)	—	—	N	Y	100	
J47	[Y2A/B/C]	61 (1061): Mount motor 1, commercial-power-driven (M1_L)	—	—	N	Y	100	
	[Y3A/B/C]	62 (1062): Mount motor 2, inverter-driven (M2_I) 63 (1063): Mount motor 2, commercial-power-driven (M2_L) 64 (1064): Mount motor 3, inverter-driven (M3_I) 65 (1065): Mount motor 3, commercial-power-driven (M3_L) 67 (1067): Mount motor 4, commercial-power-driven (M4_L) 68 (1068): Periodic switching early warning (MCHG) 69 (1069): Pump control limit signal (MLIM)	—	—	N	Y	100	
J48	Cumulative Run Time of Motor (Motor 0)	Indication of cumulative run time of motor for replacement	1	h	Y	Y	—	
J49	(Motor 1)		1	h	Y	Y	—	
J50	(Motor 2)		1	h	Y	Y	—	
J51	(Motor 3)		1	h	Y	Y	—	
J52	(Motor 4)		1	h	Y	Y	—	
J53	Maximum Cumulative Number of Relay ON Times [Y1A/B/C] to [Y3A/B/C]	Indication of the maximum number of ON times of relay contacts on the relay output card or those built in inverter Display of 1.000 means 1000 times.	1	Times	Y	Y	—	
J54	[Y1], [Y2], [Y3]	For relay output card	1	Times	Y	Y	—	
J55	[Y5A], [30A/B/C]	For built-in mechanical contacts	1	Times	Y	Y	—	

y codes: Link Functions

Code	Name	Data setting range	Increment	Unit	Change when running	Data copying	Default setting	Refer to page:
y01	RS-485 Communication (Standard) (Station address)	1 to 255	1	—	N	Y	1	9-131
y02	(Communications error processing)	0: Immediately trip with alarm $E-r-B$ 1: Trip with alarm $E-r-B$ after running for the period specified by timer y03 2: Retry during the period specified by timer y03. If retry fails, trip with alarm $E-r-B$. If it succeeds, continue to run. 3: Continue to run	—	—	Y	Y	0	
y03	(Error processing timer)	0.0 to 60.0	0.1	s	Y	Y	2.0	
y04	(Transmission speed)	0: 2400 bps 1: 4800 bps 2: 9600 bps 3: 19200 bps 4: 38400 bps	—	—	Y	Y	3	
y05	(Data length)	0: 8 bits 1: 7 bits	—	—	Y	Y	0	
y06	(Parity check)	0: None 1: Even parity 2: Odd parity	—	—	Y	Y	0	
y07	(Stop bits)	0: 2 bits 1: 1 bit	—	—	Y	Y	0	
y08	(No-response error detection time)	0 (No detection), 1 to 60	1	s	Y	Y	0	
y09	(Response latency time)	0.00 to 1.00	0.01	s	Y	Y	0.01	
y10	(Protocol selection)	0: Modbus RTU protocol 1: FRENIC Loader protocol (SX protocol) 2: Fuji general-purpose inverter protocol 3: Metasys-N2 (Available only for products shipped for Asia (A) and EU (E))	—	—	Y	Y	1	

(y code continued)

Code	Name	Data setting range	Increment	Unit	Change when running	Data copying	Default setting	Refer to page:	
y11	RS-485 Communication (Option) (Station address)	1 to 255	1	—	N	Y	1	9-131	
y12	(Communications error processing)	0: Immediately trip with alarm E_rP 1: Trip with alarm E_rP after running for the period specified by timer y13. 2: Retry during the period specified by timer y13. If retry fails, trip with alarm E_rP . If it succeeds, continue to run. 3: Continue to run.	—	—	Y	Y	0		
y13	(Error processing timer)	0.0 to 60.0	0.1	s	Y	Y	2.0		
y14	(Transmission speed)	0: 2400 bps 1: 4800 bps 2: 9600 bps 3: 19200 bps 4: 38400 bps	—	—	Y	Y	3		
y15	(Data length)	0: 8 bits 1: 7 bits	—	—	Y	Y	0		
y16	(Parity check)	0: None 1: Even parity 2: Odd parity	—	—	Y	Y	0		
y17	(Stop bits)	0: 2 bits 1: 1 bit	—	—	Y	Y	0		
y18	(No-response error detection time)	0: (No detection), 1 to 60	1	s	Y	Y	0		
y19	(Response latency time)	0.00 to 1.00	0.01	s	Y	Y	0.01		
y20	(Protocol selection)	0: Modbus RTU protocol 2: Fuji general-purpose inverter protocol 3: Metasys-N2 (Available only for products shipped for Asia (A) and EU (E))	—	—	Y	Y	0		
y98	Bus Link Function (Mode selection)	Frequency command	Run command	—	—	Y	Y	0	9-110 9-133
		0: Follow H30 data	Follow H30 data						
		1: Via field bus option	Follow H30 data						
		2: Follow H30 data	Via field bus option						
		3: Via field bus option	Via field bus option						
y99	Loader Link Function (Mode selection)	Frequency command	Run command	—	—	Y	N	0	9-134
		0: Follow H30 and y98 data	Follow H30 and y98 data						
		1: Via RS-485 link (Loader)	Follow H30 and y98 data						
		2: Follow H30 and y98 data	Via RS-485 link (Loader)						
		3: Via RS-485 link (Loader)	Via RS-485 link (Loader)						

9.2 Overview of Function Codes

This section provides a detailed description of the function codes available for the FRENIC-Eco series of inverters. In each code group, its function codes are arranged in an ascending order of the identifying numbers for ease of access. Note that function codes closely related each other for the implementation of an inverter's operation are detailed in the description of the function code having the youngest identifying number. Those related function codes are indicated in the right end of the title bar as shown below.

F01	Frequency Command 1	Refer to C30.
-----	---------------------	---------------

9.2.1 F codes (Fundamental functions)

F00	Data Protection
-----	-----------------

F00 specifies whether to protect function code data from accidentally getting changed by keypad operation.

Data for F00	Function
0	Disable the data protection function, allowing you to change all function code data.
1	Enable the data protection function, allowing you to change only the data for function code F00. You cannot change any other function code data.

If data protection is enabled (F00 = 1), the \triangleleft / \triangleright key operation to change data is disabled so that no function code data except F00 data can be changed from the keypad. To change F00 data, simultaneous keying of $\text{STOP} + \triangleleft$ (from 0 to 1) or $\text{STOP} + \triangleright$ (from 1 to 0) keys is required.

 Even when F00 = 1, function code data can be changed via the communications link.

For similar purposes, (WE-KP), a signal enabling editing of function code data from the keypad is provided as a terminal command for digital input terminals. For details, refer to function codes E01 to E05, E98 and E99.

F01	Frequency Command 1	Refer to C30.
-----	---------------------	---------------

F01 selects the source of reference frequency 1 (F01) or reference frequency 2 (C30) for specifying the output frequency of the inverter (motor speed).















Data for F01, C30	Function
0	Enable \triangleleft / \triangleright keys on the keypad. (Refer to Chapter 3 "OPERATION USING THE KEYPAD.")
1	Enable the voltage input to terminal [12] (0 to 10 VDC, maximum frequency obtained at 10 VDC).
2	Enable the current input to terminal [C1] (4 to 20 mA DC, maximum frequency obtained at 20 mA DC).
3	Enable the sum of voltage and current inputs to terminals [12] and [C1]. See the two items listed above for the setting range and the value required for maximum frequencies. Note: If the sum exceeds the maximum frequency (F03), the maximum frequency will apply.
5	Enable the voltage input to terminal [V2] (0 to 10 VDC, maximum frequency obtained at 10 VDC).
7	Enable (UP) and (DOWN) commands assigned to the digital input terminals. Assign (UP) command (data = 17) and (DOWN) command (data = 18) to the digital input terminals [X1] to [X5].

Note Certain source settings (e.g., communications link and multistep frequency) have priority over the one specified by F01. For details, refer to the block diagram in Section 4.2 "Drive Frequency Command Generator."

- Tip**
- You can modify the reference frequency anywhere you choose using the gain and bias settings, to these analog inputs (voltages entered via terminals [12] and [V2]; the current entered via terminal [C1]). For details, refer to function code F18.
 - You can enable the noise reduction filter that applies to the analog input (voltages entered via terminals [12] and [V2]; the current entered via terminal [C1]). For details, refer to function codes C33, C38 and C43 (Terminal [12], [C1] and [V2] (Analog input) (Filter time constant)).
 - Using the terminal command (Hz2/Hz1) assigned to one of the digital input terminals switches between frequency commands 1 and 2. For details, refer to function codes E01 to E05, E98 and E99.
 - You can modify the reference frequency specified by frequency command 1 (F01) by using the selection (C53) and switching (IVS) of normal/inverse operation. For details, refer to the description of "Switch Normal/Inverse Operation (IVS)" in function codes E01 to E05.

F02	Run Command
------------	--------------------



F02 selects the source issuing a run command for running the motor.

Data for F02	Run Command	Description
0	Keypad	<p><u>On standard keypad</u> Enables the  /  keys to start and stop the motor. The direction of rotation is determined by the commands given at terminals [FWD] and [REV].</p> <p><u>On multi-function keypad</u> Enables  /  /  keys to run (forward and reverse) and stop the motor. (There is no need to specify a rotation direction command.)</p>
1	External signal	Enables the external signals given at terminals [FWD] and [REV] to run the motor.
2	Keypad (Forward rotation)	<p>Enables only forward rotation. You cannot run the motor in the reverse direction. There is no need to specify the direction of rotation.</p> <p><u>On standard keypad</u> Enables  /  keys to run and stop the motor.</p> <p><u>On multi-function keypad</u> Enables  /  keys to run and stop the motor. Disables the  key.</p>
3	Keypad (Reverse rotation)	<p>Enables only reverse rotation. You cannot run the motor in the forward direction. There is no need to specify the direction of rotation.</p> <p><u>On standard keypad</u> Enables  /  keys to run and stop the motor.</p> <p><u>On multi-function keypad</u> Enables  /  keys to run and stop the motor. Disables the  key.</p>

Tip When function code F02 = 0 or 1, the run forward (FWD) and run reverse (REV) commands must be assigned to terminals [FWD] and [REV], respectively.

In addition to the run command (F02) described, there are several other sources available with priority over F02: Remote/Local switching, Communications link, Run forward command 2 (FWD2), and Run reverse command 2 (REV2). For details, refer to the block diagram in Section 4.3 "Drive Command Generator."

The table below shows relationship between keying and run commands in running per a keypad (F02 = 0, rotation direction is defined by the digital inputs).

Keying on the keypad		Digital inputs		Results (Final command)
 key	 key	(FWD)	(REV)	
—	ON	—	—	Stop
ON	OFF	OFF	OFF	Stop
ON	OFF	ON	OFF	Run forward
ON	OFF	OFF	ON	Run reverse
ON	OFF	ON	ON	Stop

-  **Note**
- Digital input commands (FWD) and (REV) are valid for specifying the motor rotation direction, and the commands (FWD2) and (REV2) are invalid.
 - If you have assigned the (FWD) or (REV) function to the [FWD] or [REV] terminal, you cannot change the setting of function code F02 while the terminals [FWD] and/or [REV] are on.
 - Make sure that terminals [FWD] and [REV] are off before changing the (FWD) or (REV) function from the function other than the (FWD) and (REV) functions to (FWD) or (REV) function. Because, if under this condition you assign the (FWD) or (REV) function to the [FWD] or [REV] terminal while the terminals [FWD] and/or [REV] are on, the motor would start running.

When "Local" is selected in Remote/Local switching, the operation of the keypad concerning run commands varies with the setting of F02. The operation also varies between the standard keypad and the multi-function keypad. For details, refer to "■ Remote and local modes" in Section 3.2.3.

F03	Maximum Frequency
------------	--------------------------

F03 specifies the maximum frequency at which the motor can run. Specifying the frequency out of the range rated for the equipment driven by the inverter may cause damage or a dangerous situation. Set a maximum frequency appropriate for the equipment.

- Data setting range: 25.0 to 120.0 (Hz)

 CAUTION
The inverter can easily accept high-speed operation. When changing the speed setting, carefully check the specifications of motors or equipment beforehand.
Otherwise injuries could occur.

-  **Note** Modifying F03 data to apply a higher output frequency requires also changing F15 data specifying a frequency limiter (high).

F04	Base Frequency	Refer to H50.
F05	Rated Voltage at Base Frequency	Refer to H51.

These function codes specify the base frequency and the voltage at the base frequency essentially required for running the motor properly. If combined with the related function codes H50 and H51, these function codes may profile the non-linear V/f pattern by specifying increase or decrease in voltage at any point on the V/f pattern.

The following description includes setups required for the non-linear V/f pattern.

At high frequencies, the motor impedance may increase, resulting in an insufficient output voltage and a decrease in output torque. This feature is used to increase the voltage at high frequencies to prevent this problem from happening. Note, however, that you cannot increase the output voltage beyond the voltage of the inverter's input power.

■ Base Frequency (F04)

Set the rated frequency printed on the nameplate labeled on the motor.

- Data setting range: 25.0 to 120.0 (Hz)

■ Rated Voltage at Base Frequency (F05)

Set 0 or the rated voltage printed on the nameplate labeled on the motor.

Data for F05	Function
0	Output a voltage in proportion to input voltage (The Automatic Voltage Regulator (AVR) is disabled.)
80 to 240 (V)	Output a voltage AVR-controlled for 200 V class series
160 to 500 (V)	Output a voltage AVR-controlled for 400 V class series

- If 0 is set, the rated voltage at base frequency is determined by the power source of the inverter. The output voltage will vary in line with any variance in input voltage.
- If the data is set to anything other than 0, the inverter automatically keeps the output voltage constant in line with the setting. When any of the automatic torque boost settings, automatic energy saving or slip compensation is active, the voltage settings should be equal to the rated voltage of the motor.

■ Non-linear V/f Pattern for Frequency (H50)

Set the frequency component at an arbitrary point of the non-linear V/f pattern.

- Data setting range: 0.0 to 120.0 Hz
(Setting 0.0 to H50 disables the non-linear V/f pattern operation.)

■ Non-linear V/f Pattern for Voltage (H51)

Sets the voltage component at an arbitrary point of the non-linear V/f pattern.

Data for H51	Function
0 to 240 (V)	Output the voltage AVR-controlled for 200 V class series
0 to 500 (V)	Output the voltage AVR-controlled for 400 V class series



If the rated voltage at base frequency (F05) is set to 0, settings of function codes H50 and H51 will be ignored.

If the auto torque boost (F37) is enabled, H50 and H51 will be ignored.

Factory settings:

For models of 22 kW or below the non-linear V/f is disabled (H50 = 0, H51 = 0.)

For models of 30 kW or above it is enabled, that is, (H50 = 5 Hz, H51 = 20 V), for the 200 V class series, (H50 = 5 Hz, H51 = 40 V) for 400 V class series.

The factory default varies depending on the inverter's rated capacity and rated input voltage. See the table below.

Function code	Name	Rated capacity (kW)	Rated input voltage*	
			200 V class series	400 V class series
F04	Base Frequency	5.5 to 75	50.0 Hz	50.0 Hz
F05	Rated Voltage at Base Frequency	5.5 to 75	200 V	400 V
H50	Non-linear V/f Pattern (Frequency)	30 or below	0 Hz	0 Hz
		37 or above	5.0 Hz	5.0 Hz
H51	Non-linear V/f Pattern (Voltage)	30 or below	0 Hz	0 Hz
		37 or above	20 V	40 V

*For Japanese models

Examples:

- Normal (linear) V/f pattern

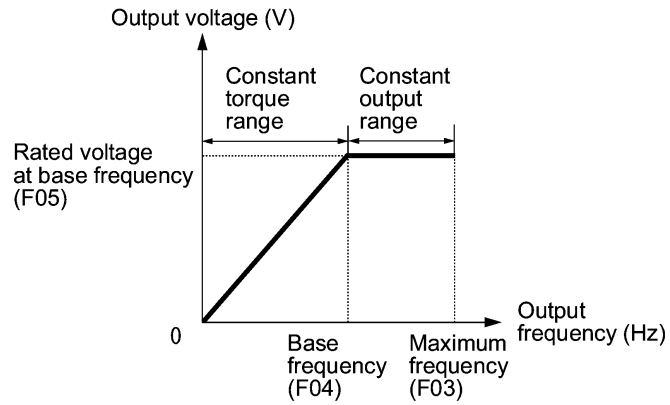

- V/f Pattern with Non-linear Point below the Base Frequency

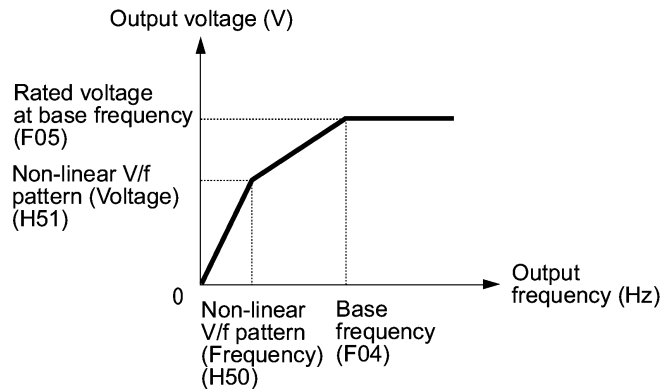

- V/f Pattern with Non-linear Point above the Base Frequency

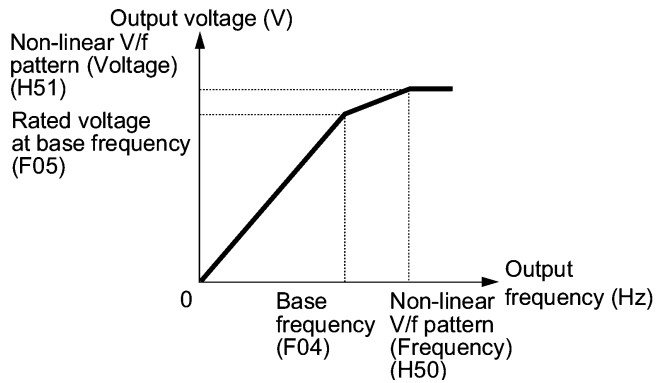

F07	Acceleration Time 1
F08	Deceleration Time 1

F07 specifies the acceleration time, the length of time the frequency increases from 0 Hz to the maximum frequency. F08 specifies the deceleration time, the length of time the frequency decreases from the maximum frequency down to 0 Hz.

- Data setting range: 0.00 to 3600 (sec.)

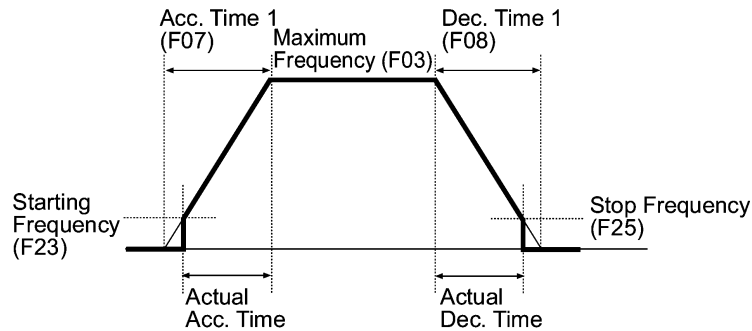

- Note**
- If you choose S-curve acceleration/deceleration or curvilinear acceleration/deceleration in Acceleration/Deceleration Pattern (H07), the actual acceleration/deceleration times are longer than the specified times. Refer to the descriptions of H07 for details.
 - If you specify an improperly short acceleration/deceleration time, the current limiting function or the automatic deceleration function (regenerative bypass function) may be activated, resulting in an actual acceleration/deceleration time longer than the specified one.

F09	Torque Boost	Refer to F37.
------------	---------------------	----------------------

F37 specifies V/f pattern, torque boost type, and auto energy saving operation for optimizing the operation in accordance with the characteristics of the load. F09 specifies the type of torque boost in order to provide sufficient starting torque.

Data for F37	V/f pattern	Torque boost	Auto-energy saving	Applicable load
0	Variable torque V/f pattern	Torque boost specified by F09	Disabled	Variable torque load increasing in proportion to square of speed General purpose fans and pumps
1	Linear V/f pattern			Constant torque load Pumps require high starting torque*1
2		Auto-torque boost Constant torque load Pumps require high start torque (A motor may be over-excited at no load.)		
3	Variable torque V/f pattern	Torque boost specified by F09	Enabled	Variable torque load increasing in proportion to square of speed General-purpose fans and pumps
4	Linear V/f pattern			Constant torque load Pumps require high start torque*1
5		Auto torque boost Constant torque load Pumps require high start torque (A motor may be over-excited at no load.)		

*1 If a required (load torque + acceleration torque) is more than 50% of the rated torque, it is recommended to apply the linear V/f pattern (factory default).

Factory default setting varies depending on the inverter's rated capacity. See the table below.

Rated capacity (kW)	5.5	7.5	11	15	18.5	22	30 or above
Factory default	3.4	2.7	2.1	1.6	1.3	1.1	0

Note FRENIC-Eco is a series of inverters exclusively designed for fans and pumps whose torque loads are characterized by a term of variable torque load that is a torque load increasing proportional to square of the load speed. FRENIC-Eco cannot drive any constant torque load even if you select a linear V/f pattern. If you attempt to drive a constant torque load with a FRENIC-Eco inverter, the inverter's current limit function may be activated or an insufficient torque situation may result, and you would need to reduce the inverter output. For details, contact your Fuji Electric representative.

■ V/f characteristics

The FRENIC-Eco series of inverters offers a variety of V/f patterns and torque boosts, which include V/f patterns suitable for variable torque load such as general fans and pumps or for special pump load requiring high start torque. Two types of torque boost are available: manual and automatic.

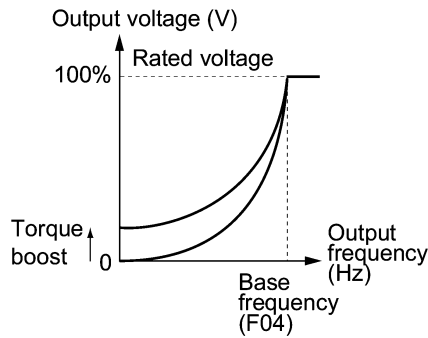

Variable torque V/f pattern (F37 = 0)

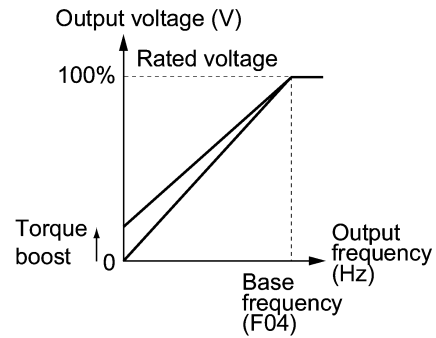

Linear V/f pattern (F37 = 1)

Tip When the variable torque load characteristics is selected in function code F37 (= 0 or 3), the output voltage may be low and insufficient voltage output may result in less output torque of the motor at a low frequency zone, depending on some motor itself and load characteristics. In such a case, it is recommended to increase the output voltage at the low frequency zone using the non-linear V/f pattern. Recommended value: H50 = 1/10 of the base frequency
H51 = 1/10 of the voltage at base frequency

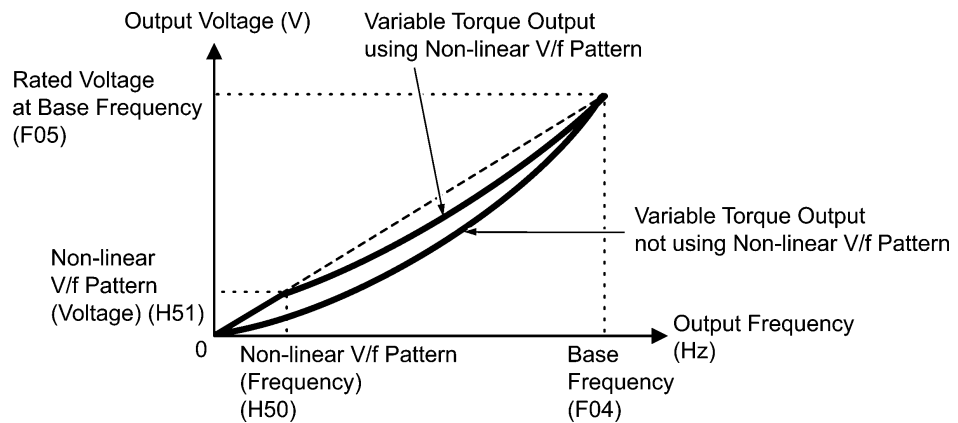

■ Torque boost

• Manual torque boost (F09)

In torque boost using F09, constant voltage is added to the basic V/f pattern, regardless of the load, to give the output voltage. To secure a sufficient start torque, manually adjust the output voltage to optimally match the motor and its load by using F09. Select an appropriate level that guarantees smooth start-up and yet does not cause over-excitation with no or light load.

Torque boost per F09 ensures high driving stability since the output voltage remains constant regardless of the load fluctuation.

Specify the data for F09 in percentage to the rated voltage at base frequency (F05). At factory shipment, F09 is preset to a level that provides approx. 50% of start torque.

Note Specifying a high torque boost level will generate a high torque, but may cause overcurrent due to over-excitation at no load. If you continue to drive the motor, it may overheat. To avoid such a situation, adjust torque boost to an appropriate level. When the non-linear V/f pattern and the torque boost are used together, the torque boost takes effect below the frequency on the non-linear V/f pattern's point.

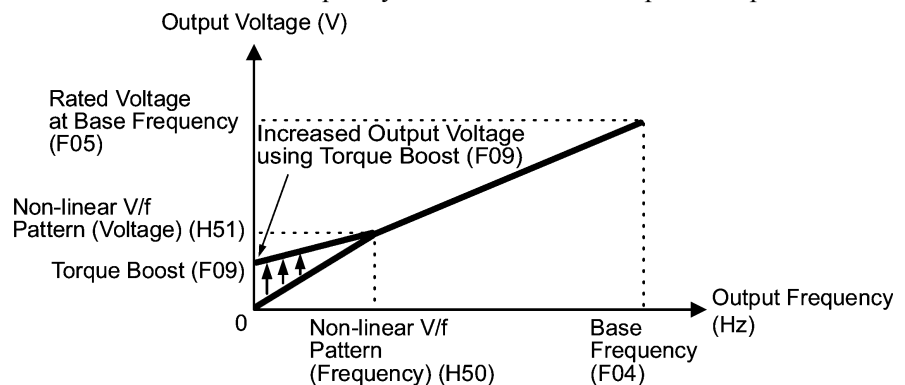

■ Automatic torque boost

This function automatically optimizes the output voltage to fit the motor with its load. Under light load, automatic torque boost decreases the output voltage to prevent the motor from over-excitation. Under heavy load, it increases the output voltage to increase output torque of the motor.

- Note**
- Since this function relies also on the characteristics of the motor, set the base frequency (F04), the rated voltage at base frequency (F05), and other pertinent motor parameters (P01 through P03 and P06 through P99) in line with the motor capacity and characteristics, or else perform auto tuning per P04.
 - When a special motor is driven or the load does not have sufficient rigidity, the maximum torque might decrease or the motor operation might become unstable. In such cases, do not use automatic torque boost but choose manual torque boost per F09 (F37 = 0 or 1).

■ Auto energy saving operation

This feature automatically controls the supply voltage to the motor to minimize the total power consumption of motor and inverter. (Note that this feature may not be effective depending upon the motor or load characteristics. Check the advantage of energy saving before actually apply this feature to your power system.)

The inverter enables this feature only upon constant speed operation. During acceleration and deceleration, the inverter will run with manual torque boost (F09) or automatic torque boost, depending on data of the function code F37. If auto energy saving operation is enabled, the response to a change in motor speed may be slow. Do not use this feature for a system that requires quick acceleration and deceleration.



- Use auto energy saving only where the base frequency is 60 Hz or lower. If the base frequency is set at 60 Hz or higher, you may get little or no energy saving advantage. The auto energy saving operation is designed for use with the frequency lower than the base frequency. If the frequency becomes higher than the base frequency, the auto energy saving operation will be invalid.
- Since this function relies also on the characteristics of the motor, set the base frequency (F04), the rated voltage at base frequency (F05), and other pertinent motor parameters (P01 through P03 and P06 through P99) in line with the motor capacity and characteristics, or else perform auto tuning per P04.

F10	Electronic Thermal Overload Protection for Motor (Select motor characteristics)
F11	Electronic Thermal Overload Protection for Motor (Overload detection level)
F12	Electronic Thermal Overload Protection for Motor (Thermal time constant)

F10 through F12 specify the thermal characteristics of the motor for its electronic thermal overload protection that is used to detect overload conditions of the motor inside the inverter.

F10 selects the motor cooling mechanism to specify its characteristics, F11 specifies the overload detection current, and F12 specifies the thermal time constant.



Thermal characteristics of the motor specified by F10 and F12 are also used for the overload early warning. Even if you need only the overload early warning, set these characteristics data to these function codes. To disable the electronic thermal motor overload protection, set function code F11 to "0.00."

■ Select motor characteristics (F10)

F10 selects the cooling mechanism of the motor--shaft-driven or separately powered cooling fan.

Data for F10	Function
1	For a general-purpose motor with shaft-driven cooling fan (The cooling effect will decrease in low frequency operation.)
2	For an inverter-driven motor, non-ventilated motor, or motor with separately powered cooling fan (The cooling effect will be kept constant regardless of the output frequency.)

The figure below shows operating characteristics of the electronic thermal overload protection when $F10 = 1$. The characteristic factors α_1 through α_3 as well as their corresponding switching frequencies f_2 and f_3 vary with the characteristics of the motor. The tables below lists the factors of the motor selected by P99 (Motor Selection).

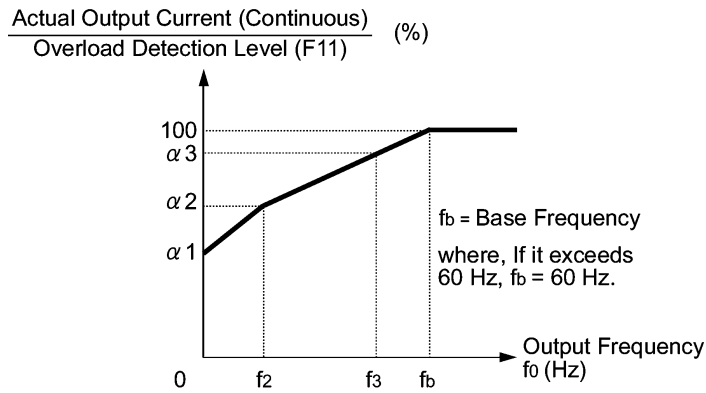

Cooling Characteristics of Motor Equipped with a Shaft-driven Cooling Fan

Applicable Motor Rating and Characteristic Factors when P99 (Motor selection) = 0 or 4

Applicable motor rating (kW)	Thermal time constant τ (Factory default)	Output current for setting the thermal time constant (I_{max})	Switching frequency for motor characteristic factor		Characteristic factor (%)		
			f_2	f_3	α_1	α_2	α_3
0.4, 0.75	5 min	Rated current $\times 150\%$	5 Hz	7 Hz	75	85	100
1.5 to 3.7					85	85	100
5.5 to 11				6 Hz	90	95	100
15				7 Hz	85	85	100
18.5, 22				5 Hz	92	100	100
30 to 45	10 min		Base frequency $\times 33\%$	Base frequency $\times 83\%$	54	85	95
55 to 90					51	95	95
110 or above					53	85	90

Applicable Motor Rating and Characteristic Factors when P99 (Motor selection) = 1 or 3

Applicable motor rating (kW)	Thermal time constant τ (Factory default)	Output current for setting the thermal time constant (I_{max})	Switching frequency for motor characteristic factor		Characteristic factor (%)		
			f_2	f_3	α_1	α_2	α_3
0.2 to 22	5 min	Rated current $\times 150\%$	Base frequency $\times 33\%$	Base frequency $\times 33\%$	69	90	90
30 to 45	10 min			Base frequency $\times 83\%$	54	85	95
55 to 90					51	95	95
110 or above					53	85	90

■ Overload detection level (F11)

F11 specifies the level at which the electronic thermal overload protection becomes activated.

- Data setting range: 1 to 135% of the rated current (allowable continuous drive current) of the inverter

In general, set F11 to the rated current of motor when driven at the base frequency (i.e. 1.0 to 1.1 multiple of the rated current of motor (P03)). To disable the electronic thermal overload protection, set F11 to "0.00: Disable."

■ Thermal time constant (F12)

F12 specifies the thermal time constant of the motor. The time constant is the time until the electronic thermal overload protection detects the motor overload while the current of 150% of the overload detection level specified by F11 has flown. The thermal constants of most general-purpose motors including Fuji motors are set at about 5 minutes for capacities of 22 kW or below or about 10 minutes for capacities of 30 kW or above by factory default.

- Data setting range: 0.5 to 75.0 (minutes) in increments of 0.1 minute

(Example) When function code F12 is set at "5.0" (5 minutes)

As shown below, the electronic thermal overload protection is activated to detect an alarm condition (alarm code $\overline{L}L$ /) when the output current of 150% of the overload detection level (specified by F11) flows for 5 minutes, and 120% for approx. 12.5 minutes.

The actual driving time required for issuing a motor overload alarm tends to be shorter than the value specified as the time period from when the output current exceeds the rated current (100%) until it reaches 150% of the overload detection level.

Example of Operating Characteristics

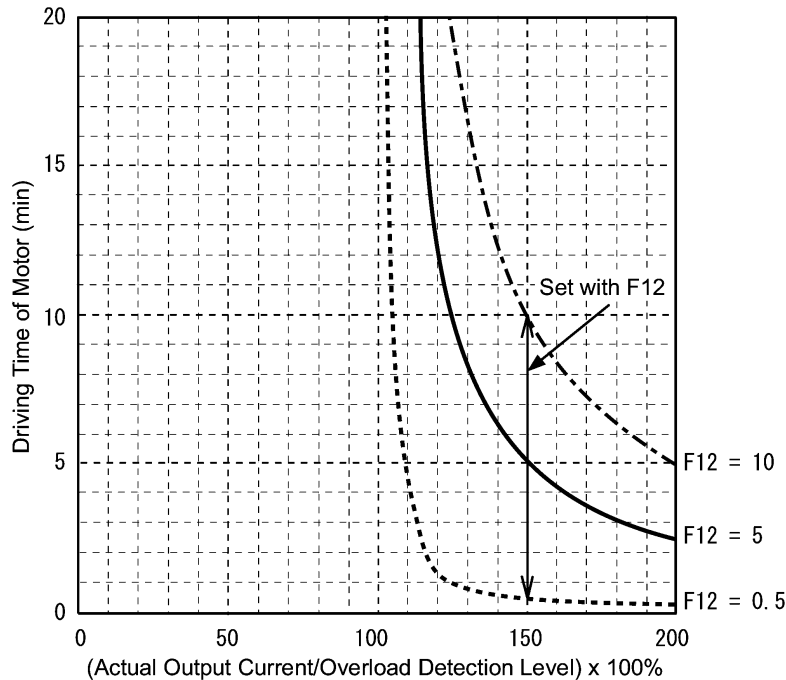

F14**Restart Mode after Momentary Power Failure (Mode selection)**

Refer to H13, H14, H15, H16, H92 and H93.

F14 specifies the action to be taken by the inverter such as trip and restart in the event of a momentary power failure.

■ Restart mode after momentary power failure (Mode selection) (F14)

Data for F14	Mode	Description
0	Disable restart (Trip immediately)	As soon as the DC link bus voltage drops below the undervoltage detection level upon a momentary power failure, the output of the inverter is shut down, with undervoltage alarm $\angle\angle'$ issued, and the motor enters a coast-to-stop state.
1	Disable restart (Trip after a recovery from power failure)	As soon as the DC link bus voltage drops below the undervoltage detection level upon a momentary power failure, the output of the inverter is shut down, the motor enters a coast-to-stop state, but no undervoltage alarm $\angle\angle'$ issued. When power is restored, an undervoltage alarm $\angle\angle'$ is issued, while the motor remains in a coast-to-stop state.
3	Enable restart (Keep running, for heavy inertia or general loads)	When the DC link bus voltage drops below the continuous running level upon a momentary power failure, continuous running control is invoked. Continuous running control regenerates kinetic energy from the load's moment of inertia, slowing down the motor and prolongs the running time. When an undervoltage condition is detected due to a lack of energy to be regenerated, the output frequency at that time is saved, the output of the inverter is shut down, and the motor enters a coast-to-stop state. When power is restored, if a run command has been input, restart begins at the reference frequency saved during the power failure processing. This setting is ideal for fan applications with a large moment of inertia.
4	Enable restart (Restart at the frequency at which the power failure occurred, for general loads)	As soon as the voltage of the DC link bus drops below the undervoltage detection level upon a momentary power failure, the output frequency at the time is saved, the output of the inverter is shut down, and the motor enters a coast-to-stop state. When power is restored, if a run command has been input restart begins at the reference frequency saved during the power failure processing. This setting is ideal for applications with a moment of inertia large enough not to slow down the motor quickly, such as fans, even after the motor enters a coast-to-stop state upon occurrence of a momentary power failure.
5	Enable restart (Restart at the starting frequency, for low-inertia load)	After a momentary power failure, when power is restored and then a run command is input, restart will begin at the starting frequency commanded by function code F23. This setting is ideal for heavy load applications such as pumps, having a small moment of inertia, in which the motor speed quickly goes down to zero as soon as it enters a coast-to-stop state upon occurrence of a momentary power failure.

⚠ WARNING

If you enable the "Restart mode after momentary power failure" (Function code F14 = 3, 4, or 5), the inverter automatically restarts the motor running when the power is recovered. Design the machinery or equipment so that human safety is ensured after restarting.

Otherwise an accident could occur.

■ Restart mode after momentary power failure (Basic operation)

The inverter recognizes a momentary power failure upon detecting the condition that DC link bus voltage goes below the undervoltage level, while the inverter is running. If the load of the motor is light and the duration of the momentary power failure is extremely short, the voltage drop may not be great enough for a momentary power failure to be recognized, and the motor may continue to run uninterrupted.

Upon recognizing a momentary power failure, the inverter enters the restart mode (after a recovery from momentary power failure) and prepares for restart. When power is recovered, the inverter goes through an initial charging stage and enters the ready-to-run state. When a momentary power failure occurs, the power supply voltage for external circuits such as relay sequence circuits may also drop, the run command may be turned off. In consideration of such a situation, the inverter waits 2 seconds for input of a run command after the inverter enters ready-to-run state. If a run command is received within 2 seconds, the inverter begins the restart processing in accordance with the data of F14 (Mode selection). If no run command has been received within 2-second wait period, the restart mode (after a recovery from momentary power failure) will be canceled, and the inverter needs to be started again from the ordinary starting frequency. Therefore, ensure that a run command is entered within 2 seconds after a recovery of power, or install a mechanical latch relay.

In case the run commands are entered via the keypad, the above operation is also necessary for the mode (F02 = 0) in which the direction of rotation is determined by the terminal command, (FWD) or (REV). In the modes where the direction of rotation is fixed (F02 = 2 or 3), the direction of rotation is retained inside the inverter, and the restart will begin as soon as the inverter enters the ready-to-run state.

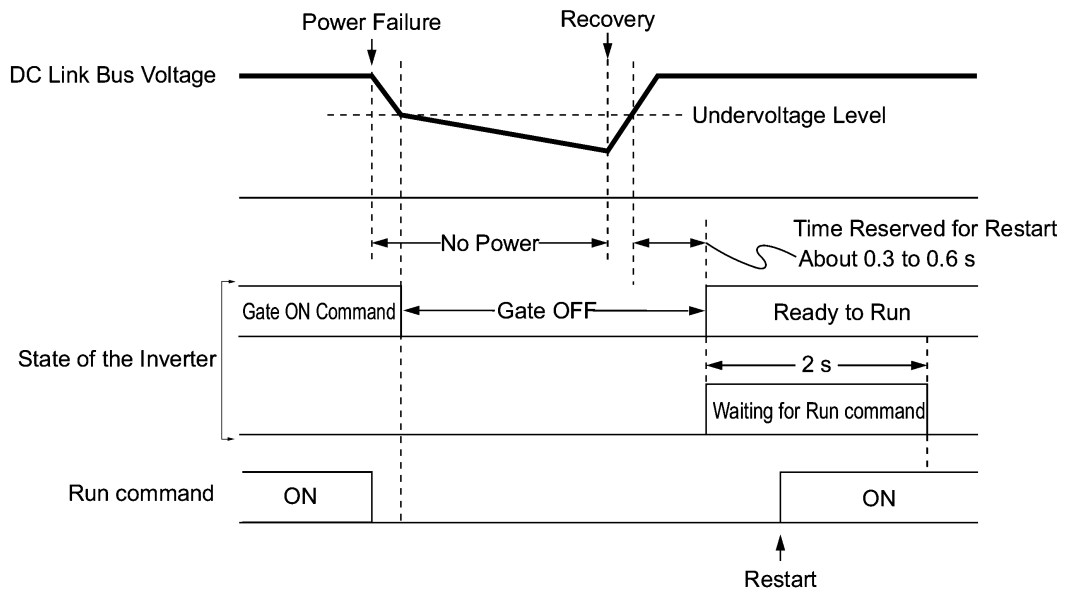



When the power is recovered, the inverter will wait 2 seconds for input of a run command. However, if the allowable momentary power failure time (H16) elapses after the power failure was recognized, even within the 2 seconds, the restart time for a run command is canceled. The inverter will start operation in the normal starting sequence.

If a coast-to-stop command (BX) is entered during the power failure, the inverter gets out of the restart mode and enters the normal running mode. If a run command is entered with power supply applied, the inverter will start from the normal starting frequency.

The inverter recognizes a momentary power failure by detecting an undervoltage condition whereby the voltage of the DC link bus goes below the lower limit. In a configuration where a magnetic contactor is installed on the output side of the inverter, the inverter may fail to recognize a momentary power failure because the momentary power failure shuts down the operating power of the magnetic contactor, causing the contactor circuit to open. When the contactor circuit is open, the inverter is cut off from the motor and load, and the voltage drop in the DC link bus is not great enough to be recognized as a power failure. In such an event, restart after a recovery from momentary power failure does not work properly as designed. To solve this, connect the interlock command (IL) line to the auxiliary contact of the magnetic contactor, so that a momentary power failure can sure be detected.

During a momentary power failure the motor slows down. After power has been recovered, the inverter is restarted at the frequency just before the momentary power failure. Then, the current limiting function works and the output frequency of the inverter automatically decreases. When the output frequency matches the motor speed, the motor accelerates up to the original frequency. See the figure below. In this case, the instantaneous overcurrent limiting must be enabled (H12 = 1).

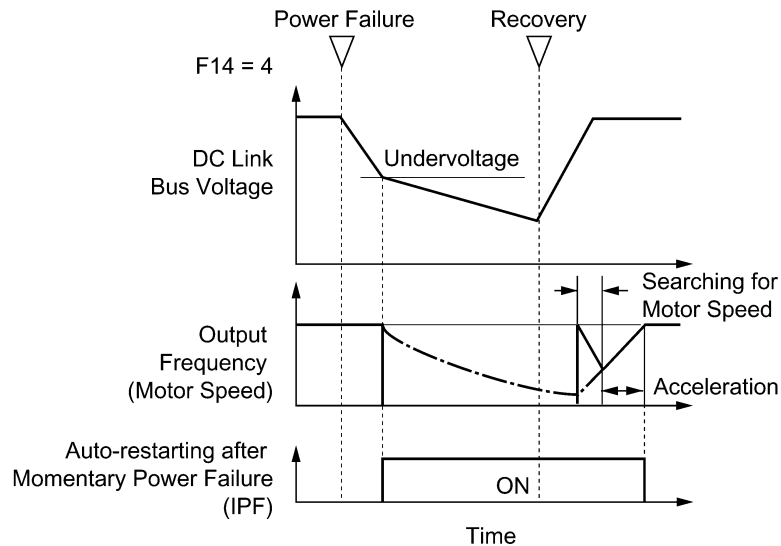

■ Restart mode after momentary power failure
(Allowable momentary power failure time) (H16)

H16 specifies the maximum allowable duration (0.0 to 30.0 seconds) from an occurrence of a momentary power failure (undervoltage) until the inverter is to be restarted. Specify the coast-to-stop time during which the machine system and facility can be tolerated.

If the power is recovered within the specified duration, the inverter restarts in the restart mode specified by F14. If the power is recovered after the specified duration, the inverter recognizes that the power has been shut down so that it does not restart but starts (normal starting).

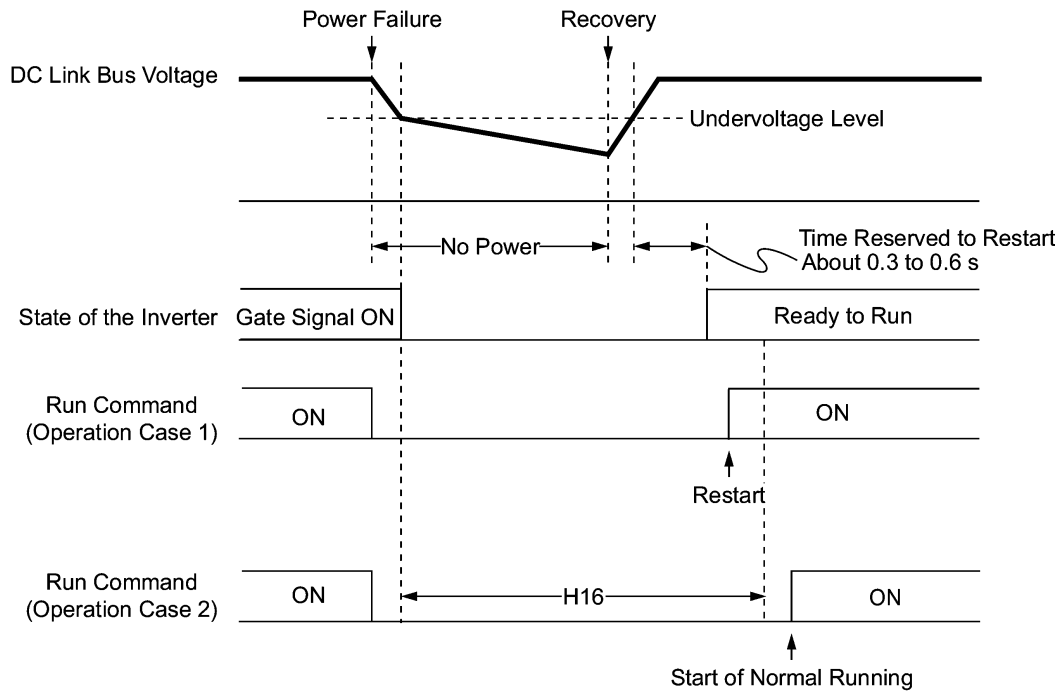

If you set the allowable momentary power failure time (H16) to "999," restart will take place until the DC link bus voltage drops down to the allowable voltage for restart after a momentary power failure as shown below. If the DC link bus voltage drops below the allowable voltage for restart after momentary power failure, the inverter recognizes that the power has been shut down so that it does not restart but starts (normal starting).

Allowable voltage for restart after momentary power failure

Power supply	Allowable voltage for restart after momentary power failure
200 V class series	50 V
400 V class series	100 V

Note The time required from when the DC link bus voltage drops from the threshold of undervoltage until it reaches the allowable voltage for restart after momentary power failure, greatly varies depending on the inverter capacity, the presence of options, and other factors.

■ Auto-restart after momentary power failure (Restart time) (H13)

This function specifies the time period from momentary power failure occurrence until the inverter reacts for restarting process.

If the inverter starts the motor while motor's residual voltage is still in a high level, a large inrush current may flow or an overvoltage alarm may occur due to an occurrence of temporary regeneration. For safety, therefore, it is advisable to set H13 to a certain level so that restart will take place only after the residual voltage has dropped to a low level. Note that even when power is recovered, restart will not take place until the restart time (H13) has elapsed.

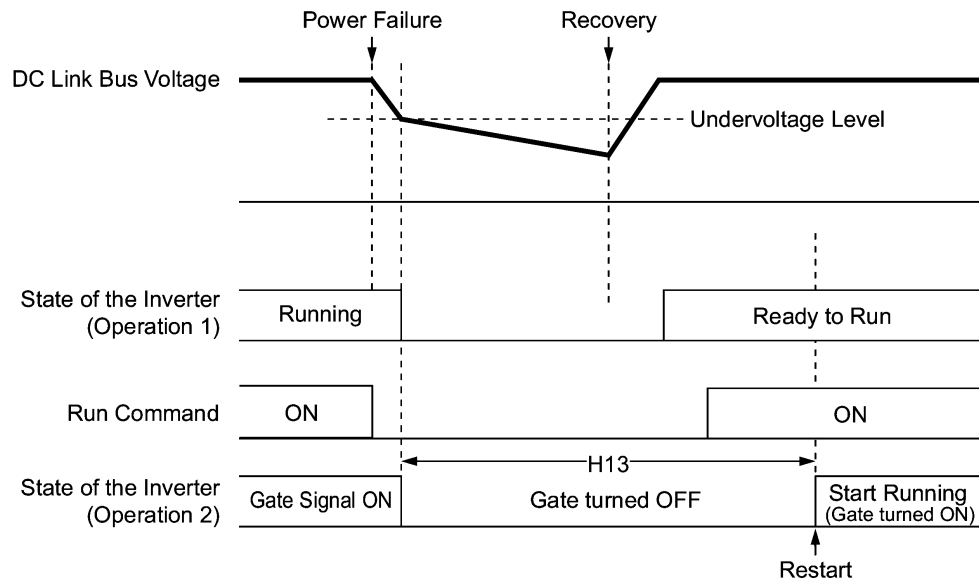

■ Factory default

By factory default, H13 is set at one of the values shown below according to the inverter capacity. Basically, you do not need to change H13 data. However, if the long restart time causes the flow rate of the pump to overly decrease or causes any other problem, you might as well reduce the setting to about a half of the default value. In such a case, make sure that no alarm occurs.

Inverter capacity (kW)	Factory default of H13 (Restart time in seconds)
0.1 to 7.5	0.5
11 to 37	1.0
45 to 110	1.5
132 to 160	2.0
200 to 280	2.5
315 to 355	4.0
400 to 500	5.0

Note Function code H13 (Restart mode after momentary power failure -- Restart time) also applies to the switching operation between line and inverter (refer to E01 through E05; terminals [X1] through [X5]).

■ Restart after momentary power failure (Frequency fall rate) (H14)

During restart after a momentary power failure, if the inverter output frequency and the motor speed cannot be harmonized with each other, an overcurrent will flow, activating the overcurrent limiter. If it happens, the inverter reduces the output frequency to match the motor speed according to the reduction rate (Frequency fall rate: Hz/s) specified by H14.

Data for H14	Inverter's action for the output frequency fall
0.00	Follow the deceleration time specified by F08
0.01 to 100.00 Hz/s	Follow data specified by H14
999	Follow the setting of the PI controller in current limiter (The PI constant is prefixed inside the inverter.)

Note If the frequency fall rate is too high, regeneration may take place at the moment the motor rotation matches the inverter output frequency, causing an overvoltage trip. On the contrary, if the frequency fall rate is too low, the time required for the output frequency to match the motor speed (duration of current limiting action) may be prolonged, triggering the inverter overload prevention control.

■ Restart after momentary power failure (Continuous running level) (H15)

■ Continue to run (P, I) (H92, H93)

If a momentary power failure occurs when the F14 data is set to "3: Enable restart (Continue to run)," the inverter enters the control sequence of the continuous running when the DC link bus voltage drops below the continuous running level specified by H15.

Under the continuous running control, the inverter decelerates its output frequency with the PI controller using P (proportional) and I (integral) components specified by H92 and H93, respectively.

For normal inverter operation, it is not necessary to modify data of H15, H92 or H93.

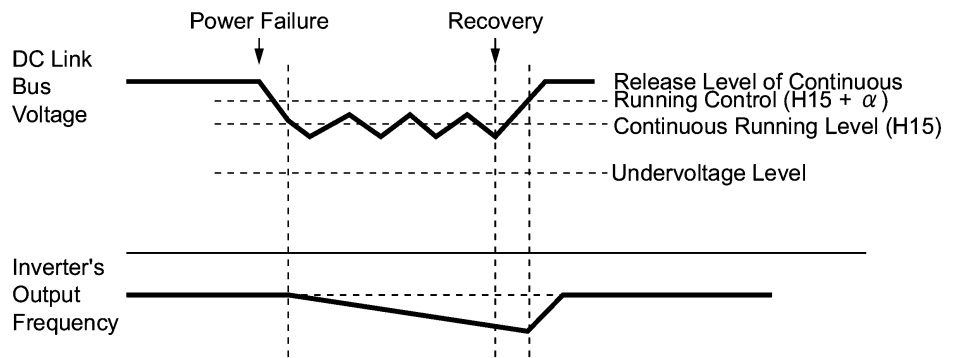

Power Supply	α	
	22 kW or below	30 kW or above
200 V	5 V	10 V
400 V	10 V	20 V



Even if you select the continuous running control, the inverter may not be able to continue operation when the load's inertia is small or the load is heavy, due to undervoltage caused by a control delay. Even in such a case, however, the output frequency when the undervoltage alarm occurred is saved and the inverter will restart at the saved frequency after a recovery from the momentary power failure.

When the input power voltage for the inverter is high, setting the continuous running level high makes the control more stable even if the load's inertia is relatively small. Raising the continuous running level too high, however, might cause the continuous running control activated even during normal operation.

When the input power voltage for the inverter is extremely low, continuous running control might be activated even during normal operation, at the beginning of acceleration or at an abrupt change in load. To avoid this, lower the continuous running level. Lowering the continuous running level too low, however, might cause undervoltage that results from voltage drop due to a control delay. Even in such a case, however, the output frequency when the undervoltage alarm occurred is saved and the inverter will restart at the saved frequency after a recovery from the momentary power failure.

Before you change the continuous running level, make sure that the continuous running control will be performed properly, by considering the fluctuations of the load and the input voltage.

F15	Frequency Limiter (High)
F16	Frequency Limiter (Low) Refer to H63.

F15 and F16 specify the upper and lower limits of the output frequency, respectively.

H63 specifies the operation to be carried out when the output frequency drops below the frequency limiter (Low) specified by F16 as follows:

- If H63 = 0, the output frequency will be held at the frequency limiter (Low).
 - If H63 = 1, the inverter decelerates to stop the motor.
- Data setting range: 0.0 to 120.0 Hz

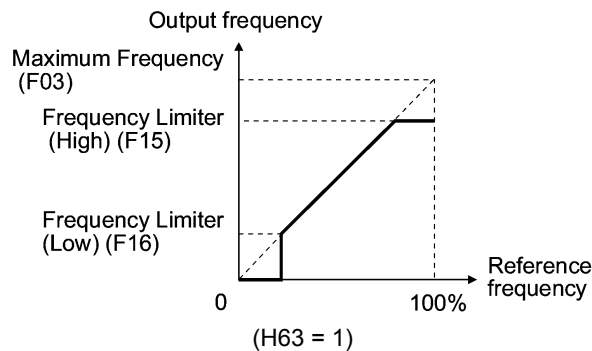
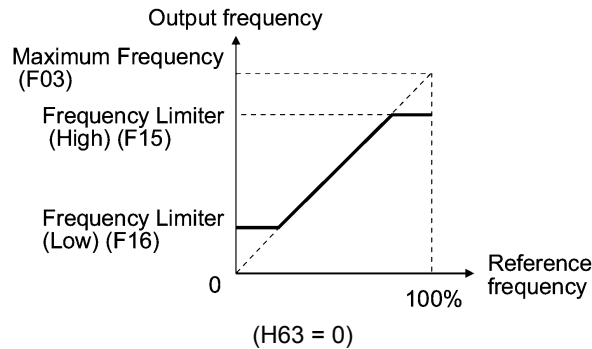

- Note**
- When you change the frequency limiter (High) (F15) in order to raise the running frequency, be sure to change the maximum frequency (F03) accordingly.
 - Maintain the following relationship among the data for frequency control:
 $F15 > F16$, $F15 > F23$, and $F15 > F25$
 $F03 > F16$

where, F23 is of the starting frequency and F25 is of the stop frequency.

If you specify any wrong data for these function codes, the inverter may not run the motor at the desired speed, or cannot start it normally.

F18**Bias (Frequency command 1)**

Refer to C50, C32, C34, C37, C39, C42 and C44.

When any analog input for frequency command 1 (F01) is used, it is possible to define the relationship between the analog input and the reference frequency by multiplying the gain and adding the bias specified by F18.

Function code	Function	Data setting range (%)
F18	Bias	-100.00 to 100.00
C50	Bias reference point	0.00 to 100.00
C32	Gain for terminal [12]	0.00 to 200.00
C34	Gain reference point for terminal [12]	0.00 to 100.00
C37	Gain for terminal [C1]	0.00 to 200.00
C39	Gain reference point for terminal [C1]	0.00 to 100.00
C42	Gain for terminal [V2]	0.00 to 200.00
C44	Gain reference point for terminal [V2]	0.00 to 100.00

As shown in the graph below, the relationship between the analog input and the reference frequency specified by frequency command 1 is determined by points "A" and "B." Point "A" is defined by the combination of the bias (F18) and its reference point (C50); Point B, by the combination of the gain (C32, C37 or C42) and its reference point (C34, C39 or C44).

The combination of C32 and C34 applies to terminal [12], that of C37 and C39, to [C1], and that of C42 and C44, to [V2].

Configure the bias (F18) and gain (C32, C37 or C42), assuming the maximum frequency as 100%, and the bias reference point (C50) and gain reference point (C34, C39 or C44), assuming the full scale (10 VDC or 20 mA DC) of analog input as 100%.

- Note**
- The analog input less than the bias reference point (C50) is limited by the bias value (F18).
 - Specifying that the data of the bias reference point (C50) is equal to or greater than that of each gain reference point (C34, C39 or C44) will be interpreted as invalid, so the inverter will reset the reference frequency to 0 Hz.

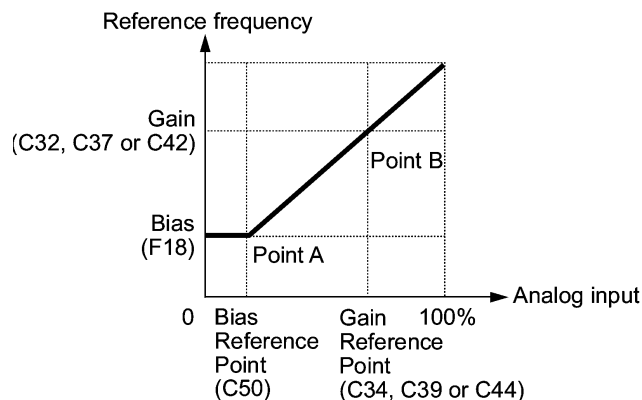

Example: Setting the bias, gain and its reference points when the reference frequency 0 to 100% follows the analog input of 1 to 5 VDC to terminal [12] (in frequency command 1).

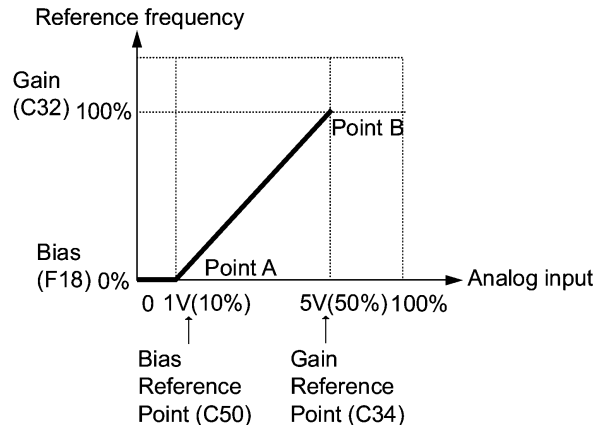

(Point A)

To set the reference frequency to 0 Hz for an analog input being at 1 V, set the bias to 0% (F18 = 0). Since 1 V is the bias reference point and it is equal to 10% of 10 V, set the bias reference point to 10% (C50 = 10).

(Point B)

To make the maximum frequency equal to the reference frequency for an analog input being at 5 V, set the gain to 100% (C32 = 100). Since 5 V is the gain reference point and it is equal to 50% of 10 V, set the gain reference point to 50% (C34 = 50).

Note The setting procedure for specifying a gain or bias alone without changing any reference points is the same as that of Fuji conventional inverters of FRENIC5000G11S/P11S series, FVR-E11S series, etc.

F20	DC Braking (Braking start frequency)	Refer to H95.
F21	DC Braking (Braking level)	
F22	DC Braking (Braking time)	

F20 through F22 specify the DC braking that prevents the motor from running by inertia during deceleration-to-stop operation.

If the motor enters a deceleration-to-stop operation by turning off the run command or by decreasing the reference frequency below the stop frequency, the inverter activates the DC braking by flowing a current at the braking level (F21) during the braking time (F22) when the output frequency reaches the DC braking start frequency (F20).

Setting the braking time to "0.0" (F22 = 0) disables the DC braking.

■ **Braking start frequency (F20)**

F20 specifies the frequency at which the DC braking starts its operation during motor deceleration-to-stop state.

- Data setting range: 0.0 to 60.0 (Hz)

■ **Braking level (F21)**

F21 specifies the output current level to be applied when the DC braking is activated. The function code data should be set, assuming the rated output current of the inverter as 100% in increments of 1%.

- Data setting range: 0 to 60 (%)

■ Braking time (F22)

F22 specifies the braking period that activates DC braking.

- Data setting range: 0.01 to 30.00 (sec.)
(Note that setting 0.00 disables DC braking.)

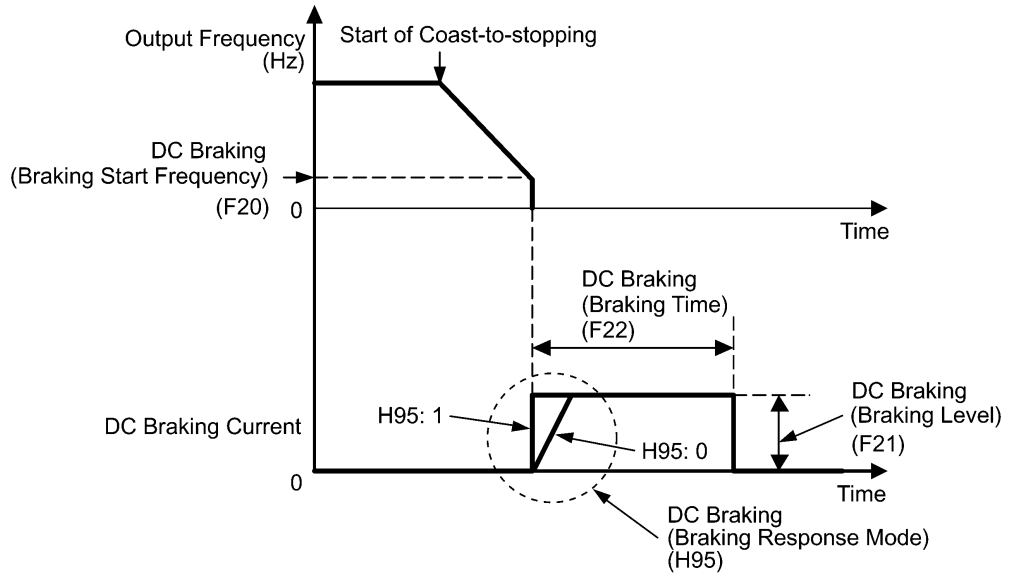

■ Braking response mode (H95)

H95 specifies the DC braking response mode.

Data for H95	Characteristics	Note
0	Slow response. Slows the rising edge of the current, thereby preventing reverse rotation at the start of DC braking.	Insufficient braking torque may result at the start of DC braking.
1	Quick response. Quickens the rising edge of the current, thereby accelerating the build-up of the braking torque.	Reverse rotation may result depending on the moment of inertia of the mechanical load and the coupling mechanism.

Tip It is also possible to use an external digital input signal as a DC braking command (DCBRK).

As long as the (DCBRK) command is ON, the inverter performs DC braking, regardless of the braking time specified by F22.

Turning the (DCBRK) command ON even when the inverter is in a stopped state activates DC braking. This feature allows the motor to be excited before starting, resulting in smoother acceleration (quicker build-up of acceleration torque).

Note In general, specify data of the function code F20 at a value close to the rated slip frequency of motor. If you set it at an extremely high value, control may become unstable and an overvoltage alarm may result in some cases.

⚠ CAUTION

The DC brake function of the inverter does not provide any holding mechanism.

Injuries could occur.

F23	Starting Frequency
F25	Stop Frequency

At the startup of an inverter, the initial output frequency is equal to the starting frequency. The inverter stops its output at the stop frequency.

Set the starting frequency to a level that will enable the motor to generate enough torque for startup. Generally, set the motor's rated slip frequency at the starting frequency F23.

- Data setting range: 0.0 to 60.0 (Hz) (for both starting and stop frequencies)

Note If the starting frequency is lower than the stop frequency, the inverter will not output any power as long as the frequency command does not exceed the stop frequency.

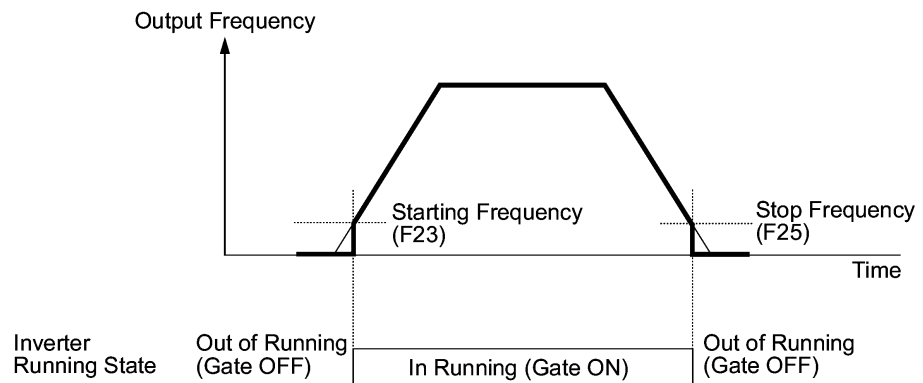

F26	Motor Sound (Carrier frequency)	Refer to H98.
F27	Motor Sound (Tone)	

■ Motor Sound (Carrier frequency) (F26)

F26 controls the carrier frequency so as to reduce an audible noise generated by the motor or inverter itself, and to decrease a leakage current from the main output (secondary) wirings.

Carrier frequency	Inverter rated capacity: 0.75 to 22 kW	0.75 to 15 kHz
	Inverter rated capacity: 30 to 75 kW	0.75 to 10 kHz
	Inverter rated capacity: 90 to 500 kW	0.75 to 6 kHz
	Inverter rated capacity: 37 to 90 kW (IP54 series)	0.75 to 4 kHz
Motor sound noise emission		High ↔ Low
Motor temperature (due to harmonics components)		High ↔ Low
Ripples in output current waveform		Large ↔ Small
Leakage current		High ↔ Low
Electromagnetic noise emission		High ↔ Low
Inverter loss		High ↔ Low



Specifying a too low carrier frequency will cause the output current waveform to have a large amount of ripples (many harmonics components). As a result, the motor loss increases, causing the motor temperature to rise. Furthermore, the large amount of ripples tends to cause a current limiting alarm. When the carrier frequency is set to 1 kHz or below, therefore, reduce the load so that the inverter output current comes to be 80% or less of the rated current.

When a high carrier frequency is specified, the temperature of the inverter may rise due to an ambient temperature rise or an increase of the load. If it happens, the inverter automatically decreases the carrier frequency to prevent the inverter overheat alarm \overline{OH} or inverter overload alarm \overline{OL} . With consideration for motor noise, the automatic reduction of carrier frequency can be disabled (see function code H98).

■ Motor Sound (Tone) (F27)

F27 changes the motor running sound tone. This setting is effective when the carrier frequency set to function code F26 is 7 kHz or lower. Changing the tone level may reduce the high and harsh running noise from the motor.

Data for F27	Function
0	Disable (Tone level 0)
1	Enable (Tone level 1)
2	Enable (Tone level 2)
3	Enable (Tone level 3)



If the sound level is set too high, the output current may become unstable, or mechanical vibration and noise may increase. Also, these function codes may not be very effective for certain types of motor.

F29	Analog Output [FMA] (Mode selection)
F30	Analog Output [FMA] (Output adjustment)
F31	Analog Output [FMA] (Function)

These function codes allow you to output to terminal [FMA] monitored data such as the output frequency and the output current in the form of an analog DC voltage or current. The magnitude of such analog voltage or current is adjustable.

■ Mode selection (F29)

F29 specifies the property of the output to terminal [FMA]. You need to set switch SW4 on the control PCB accordingly, referring to the table below.

Data for F29	Output form	Positioning slide switch (SW4) mounted on the control PCB
0	Voltage (0 to +10 VDC)	VO
1	Current (+4 to +20 mA DC)	IO



The current output is not isolated from the analog input and does not have its own independent power source. Therefore, this output must not be connected in cascade to outside instrument and gauges if some difference in potential is there between the inverter and peripheral equipment regarding connection of analog input etc. Avoid needlessly long wiring.

■ Output adjustment (F30)

F30 allows you to adjust the output voltage or current representing the monitored data selected by function code F31 within the range of 0 to 200%.

- Data setting range: 0 to 200 (%)

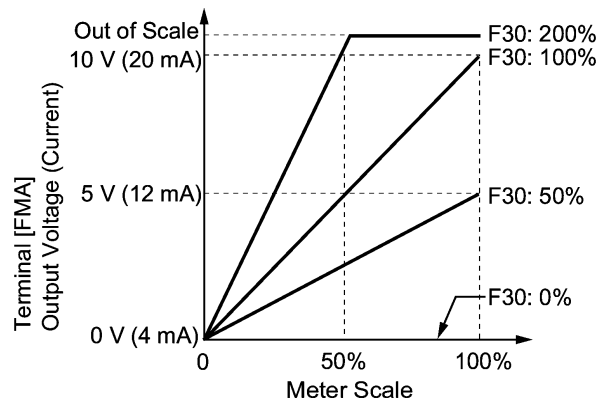

■ Function (F31)

F31 specifies what is output to the analog output terminal [FMA].

Data for F31	[FMA] output	Function (Monitor the following)	Meter scale (Full scale at 100%)
0	Output frequency	Output frequency of the inverter	Maximum frequency (F03)
2	Output current	Output current (RMS) of the inverter	Twice the inverter rated current
3	Output voltage	Output voltage (RMS) of the inverter	250 V for 200 V class series, 500 V for 400 V class series
4	Output torque	Motor shaft torque	Twice the rated motor torque
5	Load factor	Load factor (Equivalent to the indication of the load meter)	Twice the rated motor load, or <ul style="list-style-type: none"> Rated output torque of the motor at the base frequency or below Rated motor output (kW) at the base frequency or above
6	Input power	Input power of the inverter	Twice the rated output of the inverter
7	PID feedback value (PV)	Feedback value under PID control	100% of the feedback value
9	DC link bus voltage	DC link bus voltage of the inverter	500 V for 200 V class series, 1000 V for 400 V class series
10	Universal AO	Command via communications link (Refer to the RS-485 Communication User's Manual (MEH448).)	20,000 as 100%
13	Motor output	Motor output (kW)	Twice the rated motor output
14	Calibration	Full scale output of the meter calibration	10 VDC or 20 mA DC
15	PID process command (SV)	Process command under PID control	100% of the feedback value
16	PID process output (MV)	Output level of the PID controller under PID control (Frequency command)	Maximum frequency (F03)

F34	Analog Output [FMI] (Duty)
F35	Analog Output [FMI] (Function)

These function codes allow you to output to terminal [FMI] monitored data such as the output frequency and the output current in the form of an analog DC current. The magnitude of such analog current is adjustable.

■ Duty (F34)

F34 allows you to adjust the output current representing the monitored data selected by function code F35 within the range of 0 to 200%.

- Data setting range: 0 to 200 (%)

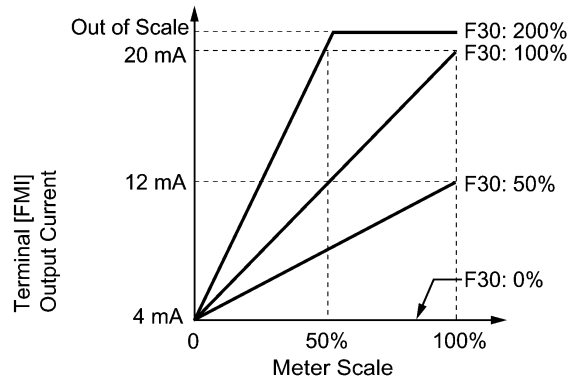

■ Function (F35)

F35 specifies what is output to the analog output terminal [FMI].

Data for F35	[FMI] output	Function (Monitor the following)	Meter scale (Full scale at 100%)
0	Output frequency	Output frequency of the inverter	Maximum frequency (F03)
2	Output current	Output current (RMS) of the inverter	Twice the inverter rated current
3	Output voltage	Output voltage (RMS) of the inverter	250 V for 200 V class series, 500 V for 400 V class series
4	Output torque	Motor shaft torque	Twice the rated motor torque
5	Load factor	Load factor (Equivalent to the indication of the load meter)	Twice the rated motor load, or <ul style="list-style-type: none"> Rated output torque of the motor at the base frequency or below Rated motor output (kW) at the base frequency or above
6	Input power	Input power of the inverter	Twice the rated output of the inverter
7	PID feedback value (PV)	Feedback value under PID control	100% of the feedback value
9	DC link bus voltage	DC link bus voltage of the inverter	500 V for 200 V class series, 1000 V for 400 V class series
10	Universal AO	Command via communications link (Refer to the RS-485 Communication User's Manual (MEH448).)	20,000 as 100%
13	Motor output	Motor output (kW)	Twice the rated motor output
14	Calibration analog output (+)	Full scale output of the meter calibration	10 VDC or 20 mA DC
15	PID process command (SV)	Process command under PID control	100% of the feedback value
16	PID process output (MV)	Output level of the PID controller under PID control (Frequency command)	Maximum frequency (F03)

F37
Load Selection/Auto Torque Boost/Auto Energy Saving Operation
Refer to F09.

Refer to the descriptions of function code F09.

F43
Current Limiter (Mode selection)
Refer to H12.
F44
Current Limiter (Level)
Refer to H12.

When the output current of the inverter exceeds the level specified by the current limiter (F44), the inverter automatically manages its output frequency to prevent a stall and limit the output current.

If F43 = 1, the current limiter is enabled only during constant speed operation. If F43 = 2, the current limiter is enabled during both of acceleration and constant speed operation. Choose F43 = 1 if you need to run the inverter at full capability during acceleration and to limit the output current during constant speed operation.

■ Operation selection (F43)

F43 selects the motor running state in which the current limiter will be active.

Data for F43	Function
0	Disable (No current limiter is active.)
1	Enable the current limiter during constant speed operation
2	Enable the current limiter during acceleration and constant speed operation

■ Operation level (F44)

F44 specifies the operation level at which the current limiter becomes activated.

- Data setting range: 20 to 120 (%) (Percentage ratio to rated current of the inverter)



- Since the current limit operation with F43 and F44 is performed by software, it may cause a delay in control. If you need a quick response, specify a current limit operation by hardware (H12 = 1) at the same time.
- If an excessive load is applied when the current limiter operation level is set extremely low, the inverter will immediately lower its output frequency. This may cause an overvoltage trip or dangerous turnover of the motor rotation due to undershooting.

9.2.2 E codes (Extension terminal functions)

E01 to E05

Command Assignment to [X1] to [X5]

Refer to E98 and E99.

Function codes E01 to E05, E98 and E99 allow you to assign commands to terminals [X1] to [X5], [FWD], and [REV] which are general-purpose, programmable input terminals.

These function codes may also switch the logic system between normal and negative to define how the inverter logic interprets either ON or OFF status of each terminal. The default setting is normal logic system "Active ON." So, explanations that follow are given in normal logic system "Active ON."

CAUTION

In the case of digital input, you can assign commands to the switching means for the run command and its operation, the reference frequency and the motor drive power (e.g., (SS1), (SS2), (SS4), (Hz2/Hz1), (SW50), (SW60), (Hz/PID), (IVS), (LE), (LOC), and (FR2/FR1)). Be aware of that switching of any of such signals may cause a sudden start (running) or an abrupt change in speed.

An accident or physical injury may result.

Function code data		Terminal commands assigned	Symbol
Active ON	Active OFF		
0	1000	Select multistep frequency	(SS1)
1	1001		(SS2)
2	1002		(SS4)
6	1006	Enable 3-wire operation	(HLD)
7	1007	Coast to a stop	(BX)
8	1008	Reset alarm	(RST)
1009	9	Enable external alarm trip	(THR)
11	1011	Switch frequency command 2/1	(Hz2/Hz1)
13	—	Enable DC brake	(DCBRK)
15	—	Switch to commercial power (50 Hz)	(SW50)
16	—	Switch to commercial power (60 Hz)	(SW60)
17	1017	UP (Increase output frequency)	(UP)
18	1018	DOWN (Decrease output frequency)	(DOWN)
19	1019	Enable write from keypad (Data changeable)	(WE-KP)
20	1020	Cancel PID control	(Hz/PID)
21	1021	Switch normal/inverse operation	(IVS)
22	1022	Interlock	(IL)
24	1024	Enable communications link via RS-485 or field bus (option)	(LE)
25	1025	Universal DI	(U-DI)
26	1026	Select starting characteristics	(STM)
1030	30	Force to stop	(STOP)
33	1033	Reset PID integral and differential components	(PID-RST)
34	1034	Hold PID integral component	(PID-HLD)
35	1035	Select local (keypad) operation	(LOC)
38	1038	Enable to run	(RE)
39	—	Protect motor from dew condensation	(DWP)
40	—	Enable integrated sequence to switch to commercial power (50 Hz)	(ISW50)
41	—	Enable integrated sequence to switch to commercial power (60 Hz)	(ISW60)
50	1050	Clear periodic switching time	(MCLR)
51	1051	Enable Pump Drive (Motor 1 to 4)	(MEN1)
52	1052		(MEN2)
53	1053		(MEN3)
54	1054		(MEN4)
87	1087	Switch run command 2/1	(FR2/FR1)
88	—	Run forward 2	(FWD2)
89	—	Run reverse 2	(REV2)
98	—	Run forward (Exclusively assigned to [FWD] and [REV] terminals by E98 and E99)	(FWD)
99	—	Run reverse (Exclusively assigned to [FWD] and [REV] terminals by E98 and E99)	(REV)

Note Any negative logic (Active OFF) command cannot be assigned to the functions marked with "—" in the "Active OFF" column.

The "Enable external alarm trip" and "Force to stop" are fail-safe terminal commands. For example, when data = "9" in "Enable external alarm trip," Active OFF (alarm is triggered when OFF); when data = 1009, "Active ON" (alarm is triggered when ON).

Terminal function assignment and data setting

- Select multistep frequency (0 to 7 steps) – (SS1), (SS2), and (SS4)
(Function code data = 0, 1, and 2)

The combination of ON/OFF states of digital input signals (SS1), (SS2) and (SS4) selects one of 8 different frequency commands defined beforehand by 7 function codes C05 to C11 (Multistep frequency 0 to 7). With this, the inverter can drive the motor at 8 different preset speeds.

The table below lists the frequencies that can be obtained by the combination of switching (SS1), (SS2), and (SS4). In the "Selected frequency" column, "Other than multistep frequency" represents the reference frequency commanded by frequency command 1 (F01), frequency command 2 (C30), or others. For details, refer to the block diagram in Section 4.2 "Drive Frequency Command Generator."

Terminal [X3] (Function code E03)	Terminal [X2] (Function code E02)	Terminal [X1] (Function code E01)	Selected frequency
2 (SS4)	1 (SS2)	0 (SS1)	
OFF	OFF	OFF	Other than multistep frequency
OFF	OFF	ON	C05 (Multistep frequency 1)
OFF	ON	OFF	C06 (Multistep frequency 2)
OFF	ON	ON	C07 (Multistep frequency 3)
ON	OFF	OFF	C08 (Multistep frequency 4)
ON	OFF	ON	C09 (Multistep frequency 5)
ON	ON	OFF	C10 (Multistep frequency 6)
ON	ON	ON	C11 (Multistep frequency 7)

- Enable 3-wire operation -- (HLD)
(Function code data = 6)

Turning this terminal command ON self-holds the forward (FWD) or reverse (REV) run command issued with it, to enable 3-wire inverter operation.

Short-circuiting the terminals between (HLD) and [CM] (i.e., when (HLD) is ON) self-holds the first (FWD) or (REV) command at its leading edge. Turning (HLD) OFF releases the self-holding.

When (HLD) is not assigned, 2-wire operation involving only (FWD) and (REV) takes effect.

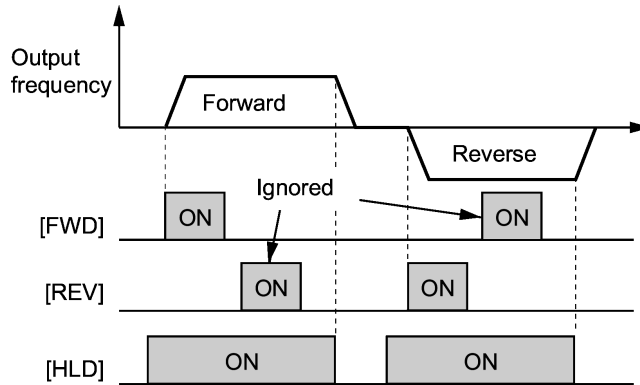

- Coast to a stop -- (BX)
(Function code data = 7)

Turning (BX) ON immediately stops the inverter output so that the motor coasts to a stop, without issuing any alarms.

- Reset alarm -- (RST)
(Function code data = 8)

Turning this terminal command ON clears the (ALM) state--alarm output (for any fault). Turning it OFF erases the alarm display and clears the alarm hold state.

When you turn the (RST) command ON, keep it ON for 10 ms or more. This command should be kept OFF for the normal inverter operation.

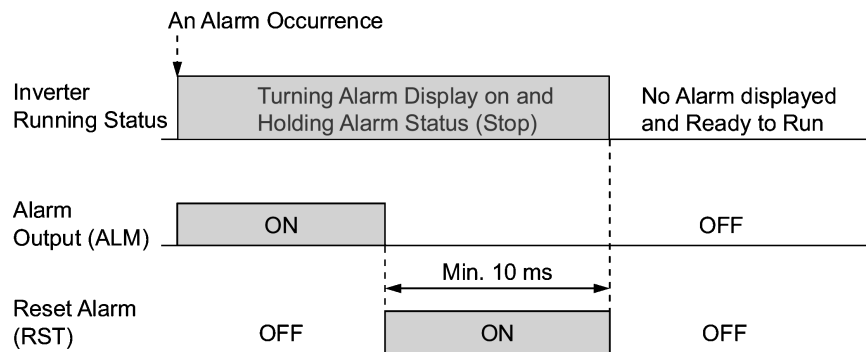

- Enable external alarm trip -- (THR)
(Function code data = 9)

Turning this terminal command OFF immediately shuts down the inverter output (so that the motor coasts to stop), displays the alarm \square , and outputs the alarm relay (for any fault) (ALM). The (THR) is self-held, and is reset when an alarm reset takes place.

 Use a trip command from external equipment when you have to immediately shut down the inverter output in the event of an abnormal situation in a peripheral equipment.

- Switch frequency command 2/1 -- (Hz2/Hz1)
(Function code data = 11)

Turning this digital input signal ON and OFF switches the frequency command source between frequency command 1 (Hz1: F01) and frequency command 2 (Hz2: C30).

If nothing is assigned to this terminal command, the frequency specified by F01 takes effect by default.

Frequency command (Hz2/Hz1)	Frequency command source
OFF	Follow F01 (Frequency command 1)
ON	Follow C30 (Frequency command 2)

 For details of the relationship with other frequency command sources, refer to Section 4.2 "Drive Frequency Command Generator."

- Enable DC brake -- (DCBRK)
(Function code data = 13)

Turning this terminal command ON activates the DC braking. As long as this command remains ON, the DC braking is working regardless of the injection braking time specified by F22. Furthermore, turning this command ON even when the inverter is in a stopped state activates DC braking. This feature allows the motor to be excited before starting, resulting in smoother acceleration (quicker build-up of acceleration torque).

 For details, refer to the description of F20 to F22.

- Switch to commercial power for 50 Hz or 60 Hz -- (SW50) or (SW60)
(Function code data = 15, 16)

When an external sequence switches the motor drive power from the commercial lines to the inverter according to the operation scheme shown on the next page, the terminal command (SW50) or (SW60) enables the FRENIC-Eco inverter to start running the motor with the current commercial power frequency, regardless settings of the reference/output frequency in the inverter. A running motor driven by commercial power is carried on into inverter operation. This command helps you smoothly switch the motor drive power source from the commercial power to the inverter power. For details, refer to the table below, the operation scheme and an example of an external sequence and its operation time scheme on the next following pages.

Assignment	The inverter:	Description
(SW50)	Starts at 50 Hz.	Do not concurrently assign both (SW50) and (SW60).
(SW60)	Starts at 60 Hz.	

Operation Scheme

- When the motor speed remains almost the same during coast-to-stop:

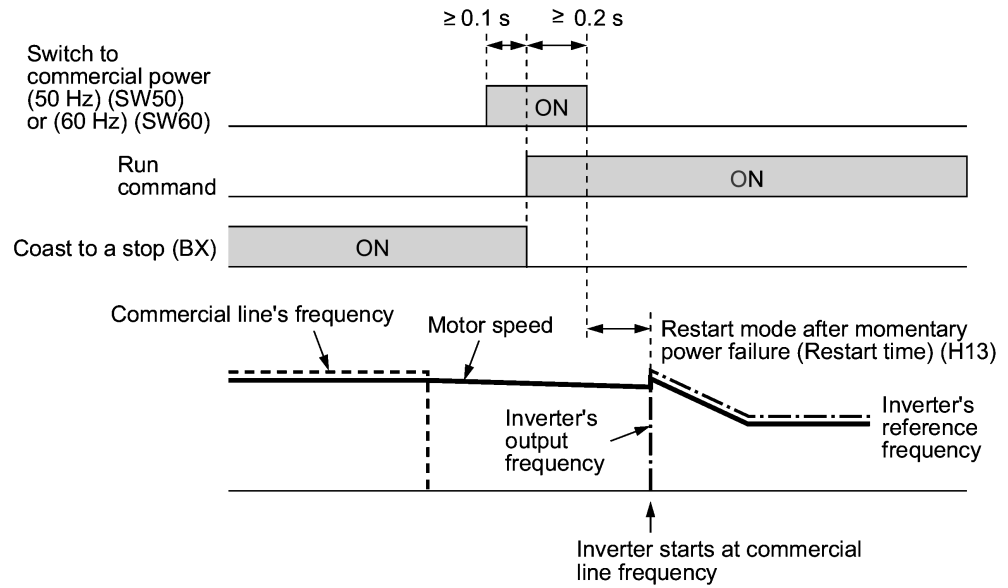

- When the motor speed decreases significantly during coast-to-stop:

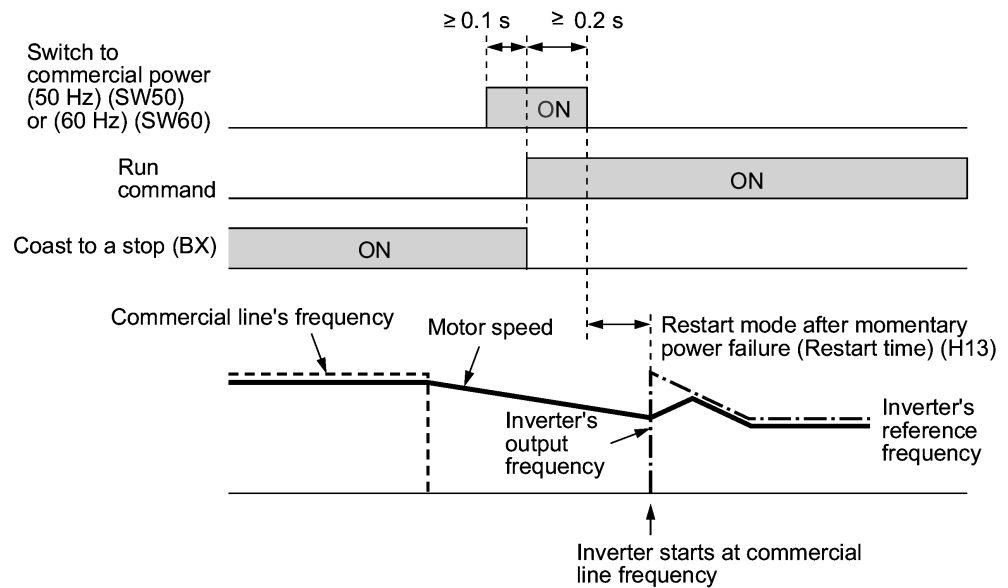



- Secure more than 0.1 second after turning ON the "Switch to commercial power" signal before turning ON a run command.
- Secure more than 0.2 second of an overlapping period with both the "Switch to commercial power" signal and run command being ON.
- If an alarm has been issued or (BX) has been ON when the motor drive source is switched from the commercial power to the inverter, the inverter will not be started at the commercial power frequency and will remain OFF. After the alarm has been reset or (BX) turned OFF, operation at the frequency of the commercial power will not be continued, and the inverter will be started at the ordinary starting frequency.

If you wish to switch the motor drive source from the commercial line to the inverter, be sure to turn (BX) OFF before the "Switch to commercial power" signal is turned OFF.

- When switching the motor drive source from the inverter to commercial power, adjust the inverter's reference frequency at or slightly higher than that of the commercial power frequency beforehand, taking into consideration the motor speed down during the coast-to-stop period produced by switching.
- Note that when the motor drive source is switched from the inverter to the commercial power, a large inrush current will be generated, because the phase of the commercial power usually does not match the motor speed at the switching. Make sure that the power supply and all the peripheral equipment are capable of withstanding this inrush current.
- If you have selected "Enable restart after a momentary power failure" (F14 = 3, 4, or 5), keep (BX) ON during commercial power driven operation to prevent the inverter from restarting after a momentary power failure.

Example of Sequence Circuit

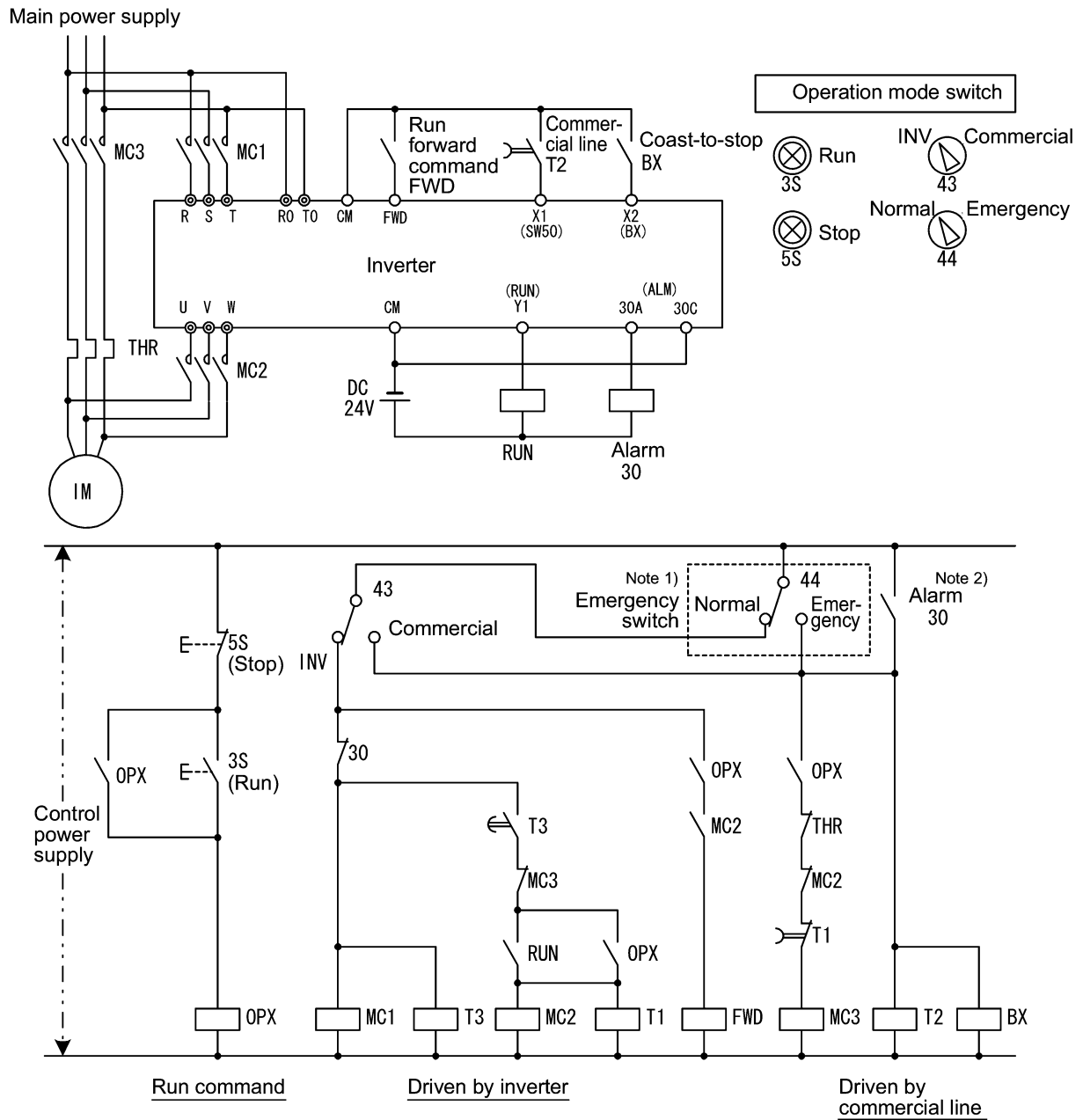

Note 1) Emergency switch

Manual switch provided for the event that the motor drive source cannot be switched normally to the commercial power due to a serious problem of the inverter

Note 2) When any alarm has occurred inside the inverter, the motor drive source will automatically be switched to the commercial power.

Example of Operation Time Scheme

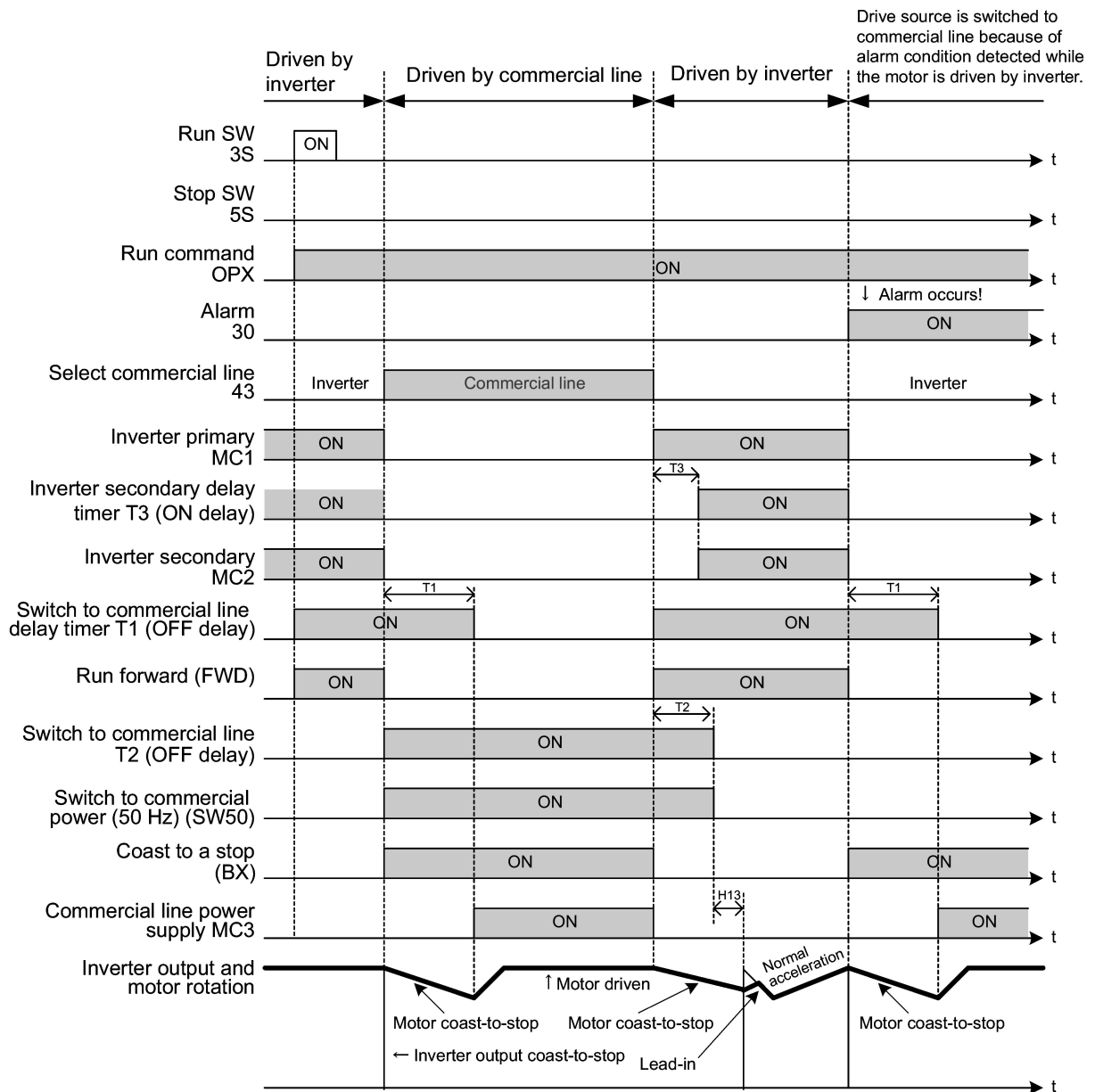

Alternatively, you may use the integrated sequence by which some of the actions above are automatically performed by the inverter itself. For details, refer to the description of (ISW50) and (ISW60).

■ UP and DOWN commands -- (UP) and (DOWN)
(Function code data = 17, 18)

• Frequency setting

When the UP/DOWN control is selected for frequency setting with the run command ON, turning the (UP) or (DOWN) command ON causes the output frequency to increase or decrease, respectively, within the range from 0 Hz to the maximum frequency as listed below.

Data = 17 (UP)	Data = 18 (DOWN)	Function
OFF	OFF	Keep the current output frequency.
ON	OFF	Increase the output frequency over the acceleration time specified by function code F07.
OFF	ON	Decrease the output frequency over the deceleration time specified by function code F08.
ON	ON	Keep the current output frequency.

In UP/DOWN control, the inverter saves the current output frequency in its internal memory. At the time of restart (including powering on), it drives the motor at the frequency saved in the memory in the last operation. Refer to the timing scheme diagram shown below and table on the next page, for details of this operation.

Note At the time of restart, if an (UP) or (DOWN) command is entered before the internal frequency reaches the frequency saved in the memory, the inverter saves the current output frequency into the memory and starts the UP/DOWN control with the new frequency. The previous frequency saved will be overwritten by the current one and be lost.

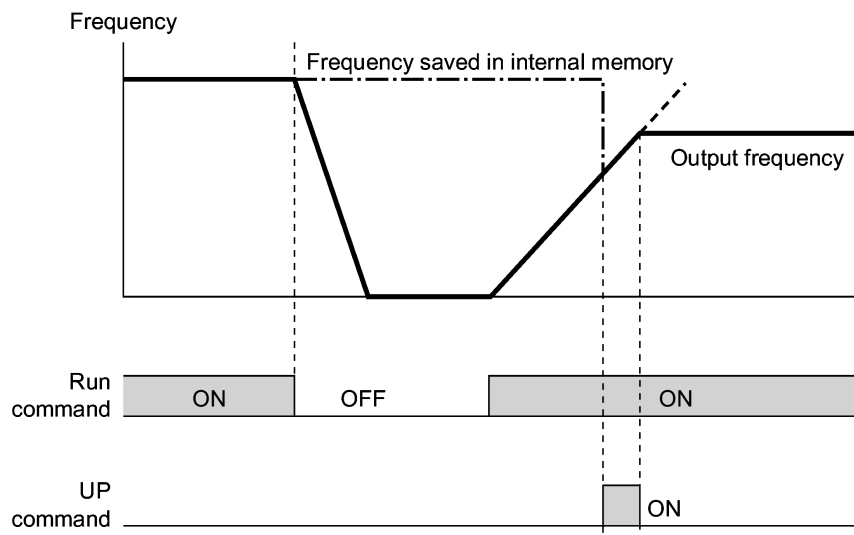

Initial settings of UP/DOWN control when the frequency command source is switched:

When the frequency command source is switched to UP/DOWN control from other sources, the initial frequency of the UP/DOWN control is as follows:

Frequency command source	Switching command	Initial frequency of UP/DOWN control
Other than UP/DOWN (F01, C30)	Frequency command 2/1 (Hz2/Hz1)	Reference frequency given by the frequency command source just before switching
Local (keypad)	Select local (keypad) operation (LOC)	Digital reference frequency given by the keypad
PID conditioner	Cancel PID control (Hz/PID)	Reference frequency given by PID control (PID controller output)
Multistep frequency	Select multistep frequency (SS1), (SS2) and (SS4)	Reference frequency at the time of previous UP/DOWN control
Communications link	Enable communications link (LE)	

 To enable the UP command (UP) and the DOWN command (DOWN), you need to set frequency command 1 (F01) or frequency command 2 (C30) to "7" beforehand.

- PID process command

While UP/DOWN control is selected as the PID process command, turning the (UP) or (DOWN) command ON when the run command is ON causes the process command to change within the range of 0 to 100%.

The setting is enabled in units of the process amount according to the PID display coefficients.

(UP)	(DOWN)	Function
Data = 17	Data = 18	
OFF	OFF	Retain the current process command.
ON	OFF	Increase the process command at a rate between 0.1%/0.1 s and 1%/0.1 s.
OFF	ON	Decrease the process command at a rate between 0.1%/0.1 s and 1%/0.1 s.
ON	ON	Retain the current process command.

The process command specified by UP/DOWN control is internally retained. At the time of restart (including power on), the operation resumes with the previous process command.

 To enable the (UP) or (DOWN) command, you need to set the remote process command (J02 = 4) beforehand.

 For details of PID control, refer to Section 4.8 "PID Frequency Command Generator" and Section 9.2.6 "J codes."

 For details of displaying the PID process command, refer to the descriptions of function codes E40 and E41 (PID display coefficients A and B).

- Enable write from keypad -- (WE-KP)
(Function code data = 19)

Turning this terminal command OFF disables changing of function code data from the keypad.

Only when this command is ON, you can change function code data from the keypad according to the setting of function code F00 as listed below.

(WE-KP)	F00	Function
OFF	Disable	Disable editing of all function code data except F00 data
ON	0	Enable editing of all function code data
	1	Inhibit editing of all function code data except that of F00

If the (WE-KP) command is not assigned to any terminal, the inverter will interpret (WE-KP) to be always ON by default.

Note If you mistakenly assign a (WE-KP) terminal command, you no longer edit or modify function code data. In such a case, temporarily turn this (WE-KP)-assigned terminal ON and reassign the (WE-KP) terminal command to a correct command.

- Cancel PID control -- (Hz/PID)
(Function code data = 20)

Turning this terminal command ON disables the PID control.

If the PID control is disabled with this command, the inverter runs the motor with the reference frequency manually set by any of the multistep, keypad, analog input, etc.

(Hz/PID)	Function
OFF	Enable PID control
ON	Disable PID control/Enable manual settings

Tip For details of PID control, refer to Section 4.8 "PID Frequency Command Generator" and Section 9.2.6 "J codes."

- Switch normal/inverse operation -- (IVS)
(Function code data = 21)

This terminal command switches the output frequency control between normal (proportional to the input value) and inverse in PID process control and manual frequency command. To select the inverse operation, turn the (IVS) command ON.

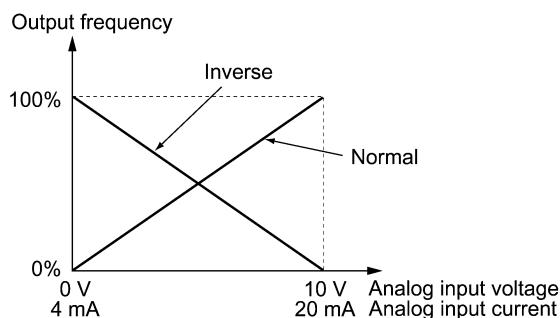

Tip The normal/inverse switching operation is useful for air-conditioners that require switching between cooling and heating. In cooling, the speed of the fan motor (output frequency of the inverter) is increased to lower the temperature. In heating, it is reduced to lower the temperature. This switching is realized by the "Switch normal/inverse operation" command.

- When the inverter is driven by an external analog frequency command sources (terminals [12], [C1], and [V2]):

The "Switch normal/inverse operation" command (IVS) can apply only to the analog frequency command sources (terminals [12], [C1] and [V2]) in frequency command 1 (F01) and does not affect frequency command 2 (C30) or UP/DOWN control.

As listed below, the combination of the "Selection of normal/inverse operation for frequency command 1" (C53) and "Switch normal/inverse operation" (IVS) determines the final operation.

Combination of C53 and (IVS)

Data for C53	(IVS)	Final operation
0: Normal operation	OFF	Normal
	ON	Inverse
1: Inverse operation	OFF	Inverse
	ON	Normal

- When the process control is performed by the PID control facility integrated in the inverter:

The "Cancel PID control" command (Hz/PID) can switch the PID control between enabled (process is to be controlled by the PID processor) and disabled (process is to be controlled by the manually frequency setting). In either case, the combination of the "PID control" (J01) or "Selection of normal/inverse operation for frequency command 1" (C53) and "Switch normal/inverse operation" (IVS) determines the final operation as listed below.

When the PID control is enabled:

The normal/inverse operation selection for the PID processor output (reference frequency) is as follows.

PID control (Mode selection) (J01)	(IVS)	Final operation
1: Enable (normal operation)	OFF	Normal
	ON	Inverse
2: Enable (inverse operation)	OFF	Inverse
	ON	Normal

When the PID control is disabled:

The normal/inverse operation selection for the manual reference frequency is as follows.

Selection of normal/inverse operation for frequency command 1 (C53)	(IVS)	Final operation
0: Normal operation	—	Normal
1: Inverse operation	—	Inverse



When the process control is performed under the PID control facility integrated in the inverter, the "Switch normal/inverse operation" (IVS) is used to switch the input (frequency setting) of the PID processor between normal and inverse, and has no effect on any normal/inverse operation selection of the manual frequency setting.



For details of PID control, refer to Section 4.8 "PID Frequency Command Generator" and Section 9.2.6 "J codes."

■ Interlock -- (IL)
(Function code data = 22)

In a configuration where a magnetic contactor (MC) is installed in the power output (secondary) circuit of the inverter, the momentary power failure detection feature provided inside the inverter may not be able to accurately detect a momentary power failure by itself. Using a digital signal input with the interlock command (IL) assures the accurate detection.

(IL)	Meaning
OFF	No momentary power failure has occurred.
ON	A momentary power failure has occurred. (Restart after a momentary power failure enabled)

The details are as follows: When the inverter detects an undervoltage condition whereby the DC link bus voltage drops below the lower limit, it recognizes the state as a momentary power failure. In the configuration above, however, the momentary power failure may shut down the exciter power for the MC, causing the MC to open. Opening the MC circuit cuts off the inverter from the motor so that the voltage drop in the DC link bus is not high enough to be recognized as a power failure. Accordingly, the "Restart after a momentary power failure" function does not work properly as designed. To assure the accurate detection, connect an interlock command (IL) line to the auxiliary contact of the MC as shown below.

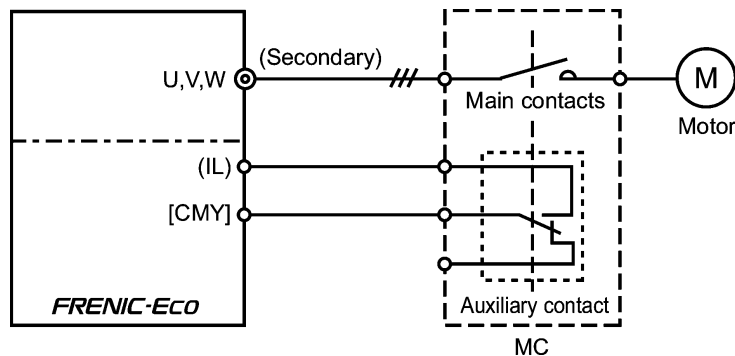

■ Enable communications link via RS-485 or field bus (option) -- (LE)
(Function code data = 24)

Turning this terminal command ON assigns priorities to frequency commands or run commands received via the RS-485 communications link (H30) or the field bus option (y98).

No (LE) assignment is functionally equivalent to the (LE) being ON.

 For details of switching, refer to H30 (Communications link function) and y98 (Bus link function).

■ Universal DI -- (U-DI)
(Function code data = 25)

Using (U-DI) enables the inverter to monitor digital signals sent from the peripheral equipment via an RS-485 communications link or a field bus option by feeding those signals to the digital input terminals. Signals assigned to the universal DI are simply monitored and do not operate the inverter.

 For an access to universal DI via the RS-485 or field bus communications link, refer to their respective Instruction Manuals.

- Select starting characteristics -- (STM)
(Function code data = 26)

This digital terminal command determines, at the start of operation, whether or not to search for idling motor's speed and follow it.

 For details of auto search for idling motor's speed, refer to H09 and H17 (Select starting characteristics).

- Force to stop -- (STOP)
(Function code data = 30)

Turning this terminal command OFF causes the motor to decelerate to a stop during the time specified by H56 (Deceleration time for forced stop). After the motor stops, the inverter enters the alarm state with alarm $\overline{E}r\overline{E}$. Apply this command to a failsafe facility.

- Reset PID integral and differential components -- (PID-RST)
(Function code data = 33)

Turning this terminal command ON resets the integral and differential components of the PID processor.

 For details of PID control, refer to Section 4.8 "PID Frequency Command Generator" and Section 9.2.6 "J codes."

- Hold PID integral component -- (PID-HLD)
(Function code data = 34)

Turning this terminal command ON holds the integral components of the PID processor.

 For details of PID control, refer to Section 4.8 "PID Frequency Command Generator" and Section 9.2.6 "J codes."

- Select local (keypad) operation -- (LOC)
(Function code data = 35)

This terminal command switches the source of the run command and frequency command between remote and local by an external digital input signal.

 For details of the local mode, refer to "Switching between remote and local modes" in Section 3.2.3.

- Enable to run -- (RE)
(Function code data = 38)

Assigning this terminal command to a digital input terminal prevents the inverter from starting to run upon receipt of a run command only. If the inverter receives a run command, it readies itself for running and outputs the status signal "Run command activated" (AX2)*. At this status, turning the (RE) command ON causes the inverter to actually start running.

*For the (AX2) signal, refer to function codes E20 to E27.

Input		Output	Inverter's operation
Run command e.g., (FWD)	(RE)	(AX2) "Run command activated"	
OFF	OFF	OFF	Stop
OFF	ON	OFF	Stop
ON	OFF	ON	Stop
ON	ON	ON	Run

Usage Example

Listed below is a typical example of starting sequence:

- (1) A run command (FWD) is issued to the inverter.
- (2) Upon receipt of the run command, the inverter readies itself for running and outputs the status signal "Run command activated" (AX2).
- (3) Upon receipt of the (AX2) signal, the host equipment starts preparation for the peripheral devices such as opening the mechanical damper/brake.
- (4) Upon completion of the preparation for the peripheral devices, the host equipment issues the "Enable to run" command (RE) to the inverter.
- (5) Upon receipt of the (RE), the inverter starts operation.

- Protect motor from dew condensation -- (DWP)
(Function code data = 39)

Turning this terminal command ON supplies a DC current to the motor that is on halt in order to generate heat, preventing dew condensation.



For details of dew condensation protection, refer to function code J21 (Dew condensation prevention (Duty)).

- Enable integrated sequence to switch to commercial power (50 Hz) -- (ISW50)
Enable integrated sequence to switch to commercial power (60 Hz) -- (ISW60)
(Function code data = 40, 41)

With the terminal command (ISW50) or (ISW60) assigned, the inverter controls the magnetic contactor that switches the motor drive source between the commercial power and the inverter output according to the integrated sequence.

This control is effective when not only (ISW50) or (ISW60)* has been assigned to the input terminal but also the (SW88) and (SW52-2)** signals have been assigned to the output terminals. (It is not essential to assign a (SW52-1) signal.)

* The (ISW50) or (ISW60) should be selected depending upon the frequency of the commercial power; the former for 50 Hz and the latter for 60 Hz.

** For the (SW88) and (SW52-2) signals for "Switch motor drive source between commercial power and inverter output," refer to function codes E20 to E27.

For details of these commands, refer to the circuit diagrams and timing schemes on the following pages.

Terminal command assigned	Operation (Switching from commercial power to inverter)
(ISW50) Enable integrated sequence to switch to commercial power (50 Hz)	Start at 50 Hz.
(ISW60) Enable integrated sequence to switch to commercial power (60 Hz)	Start at 60 Hz.



Do not assign both (ISW50) and (ISW60) at the same time. Doing so cannot guarantee the result.

Circuit Diagram and Configuration

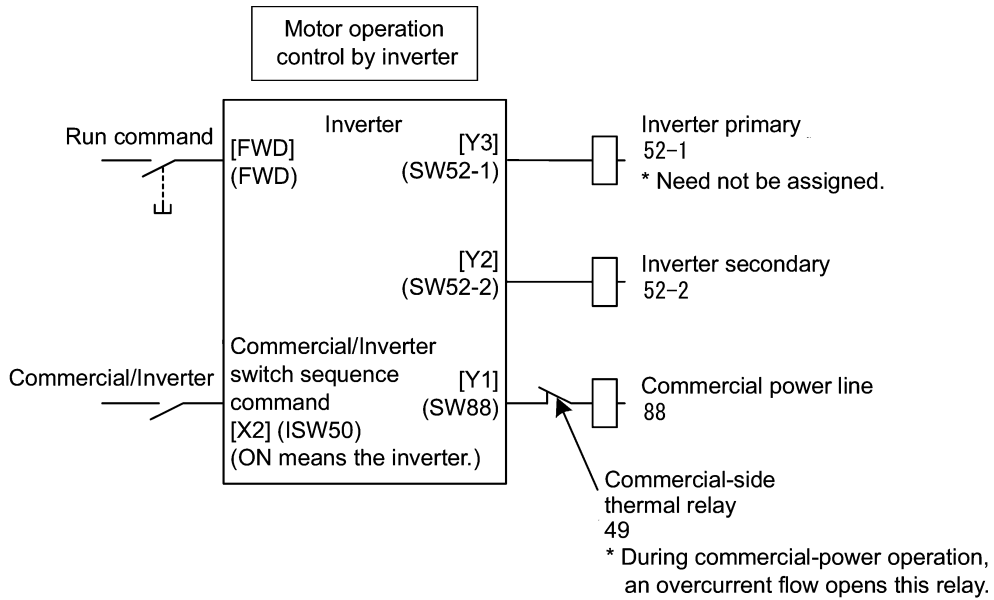
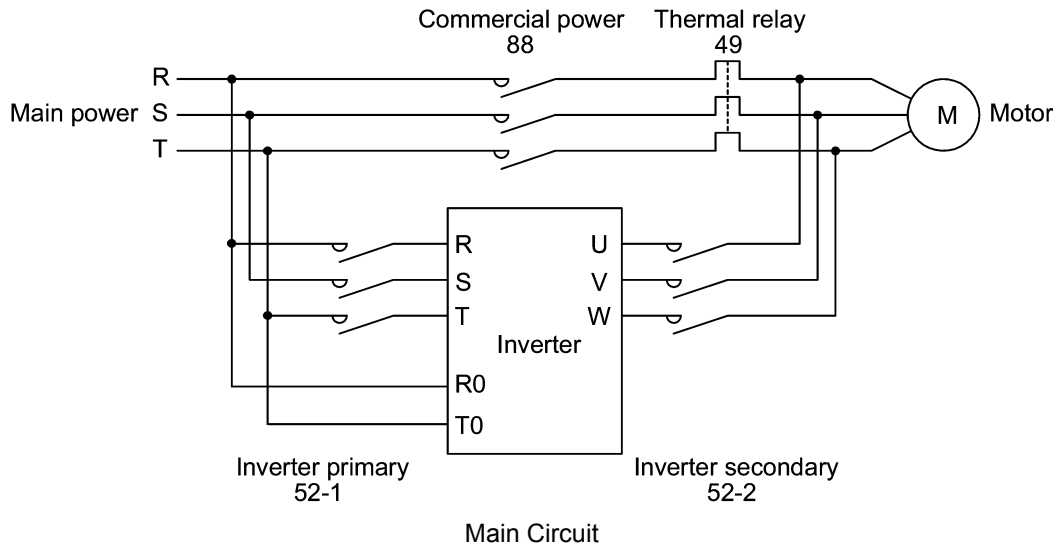

Configuration of Control Circuit

Summary of Operation

Input		Output (Status signal and magnetic contactor)			Inverter operation
(ISW50) or (ISW60)	Run command	(SW52-1) 52-1	(SW52-2) 52-2	(SW88) 88	
OFF (Commercial power)	ON	OFF	OFF	ON	OFF
	OFF			OFF	
ON (Inverter)	ON	ON	ON	OFF	ON
	OFF			OFF	

Timing Scheme

Switching from inverter operation to commercial-power operation
(ISW50)/(ISW60): ON → OFF

- (1) The inverter output is shut off immediately (Power gate IGBT OFF)
- (2) The inverter primary circuit (SW52-1) and the inverter secondary side (SW52-2) are turned off immediately.
- (3) If a Run command is present after a lapse of t_1 (time specified by function code H13 + 0.2 sec), the commercial power circuit (SW88) is turned on .

Switching from commercial-power operation to inverter operation
(ISW50)/(SW60): OFF → ON

- (1) The inverter primary circuit (SW52-1) is turned on immediately .
- (2) The commercial power circuit (SW88) is immediately shut off,
- (3) After an elapse of t_2 (time required for the main circuit to get ready + 0.2 sec) after (SW52-1) is turned on, the inverter secondary circuit (SW52-2) is turned on.
- (4) After an elapse of t_3 (time specified by H13 + 0.2 sec) from when (SW52-2) is turned on, the inverter starts to harmonize the motor that has freed from the commercial-power operation. Then the motor returns to the operation driven by the inverter.

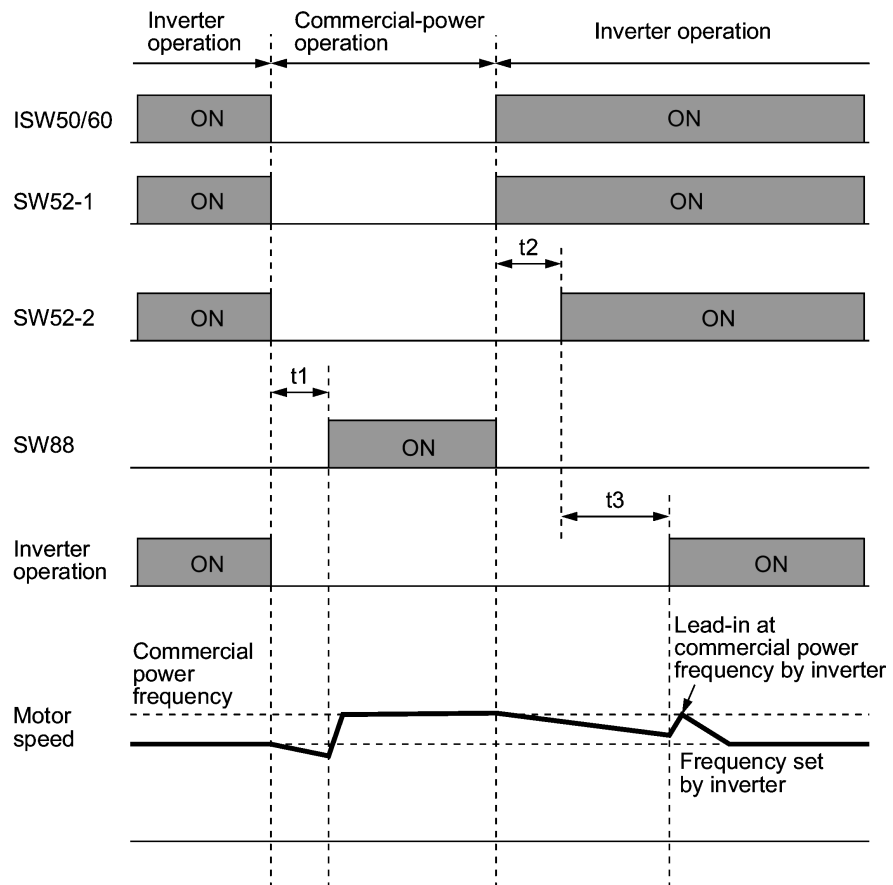

t_1 : 0.2 sec + Time specified by H13 (Restart mode after momentary power failure)

t_2 : Time required for inverter to get ready + 0.2 sec

t_3 : 0.2 sec + Time specified by H13 (Restart mode after momentary power failure)

Selection of Commercial Power Switching Sequence

Function code J22 specifies whether or not to automatically switch to commercial-power operation when an inverter alarm occurs.

Data for J22	Sequence (for occurrence of an alarm)
0	Keep inverter-operation (Stop due to alarm.)
1	Automatically switch to commercial-power operation

- Note**
- The sequence operates normally also even when (SW52-1) is not used and the main power of the inverter is supplied at all times.
 - Using (SW52-1) requires connecting the input terminals [R0] and [T0] for an auxiliary control power. Without the connection, turning (SW52-1) OFF loses also the control power.
 - The sequence operates normally even if an alarm occurs in the inverter except when the inverter itself is broken. Therefore, for a critical facility, be sure to install an emergency switching circuit outside the inverter.
 - Turning ON both the magnetic contactor MC (88) at the commercial-power side and the MC (52-2) at the inverter output side at the same time supplies main power mistakenly from the output (secondary) side of the inverter, damaging the inverter. To prevent it, be sure to set up an interlocking logic outside the inverter.

Examples of Sequence Circuits

1) Standard sequence

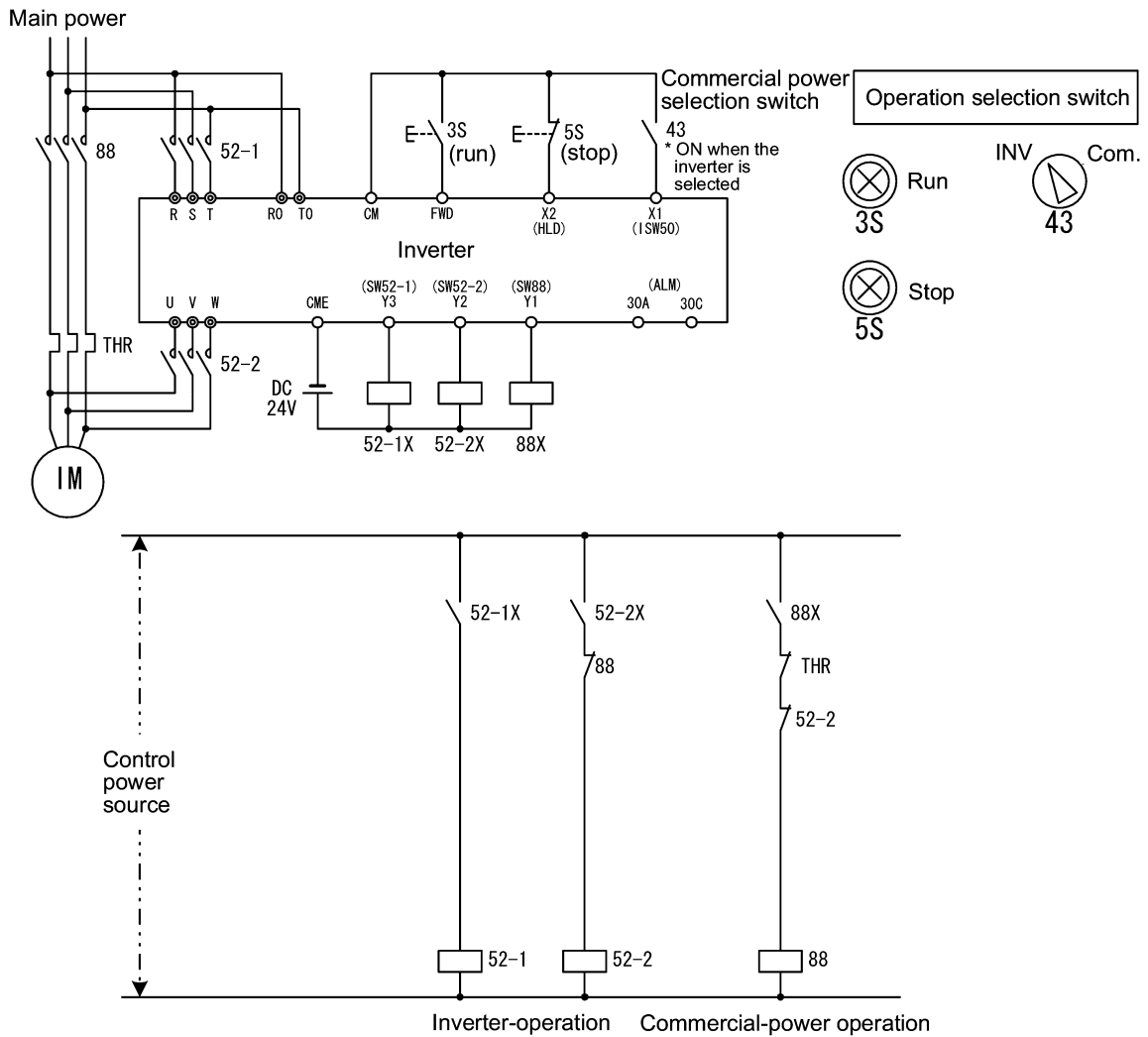

2) Sequence with an emergency switching function

Main power

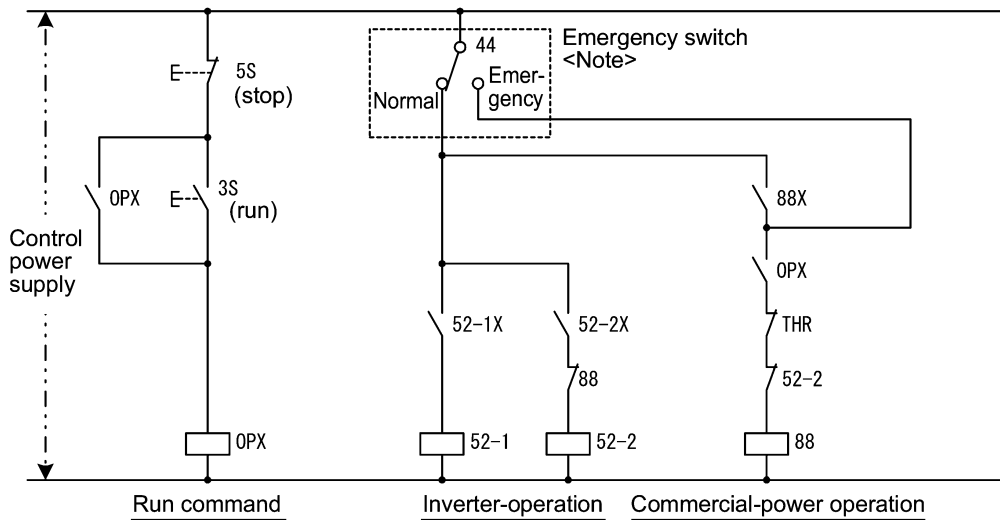
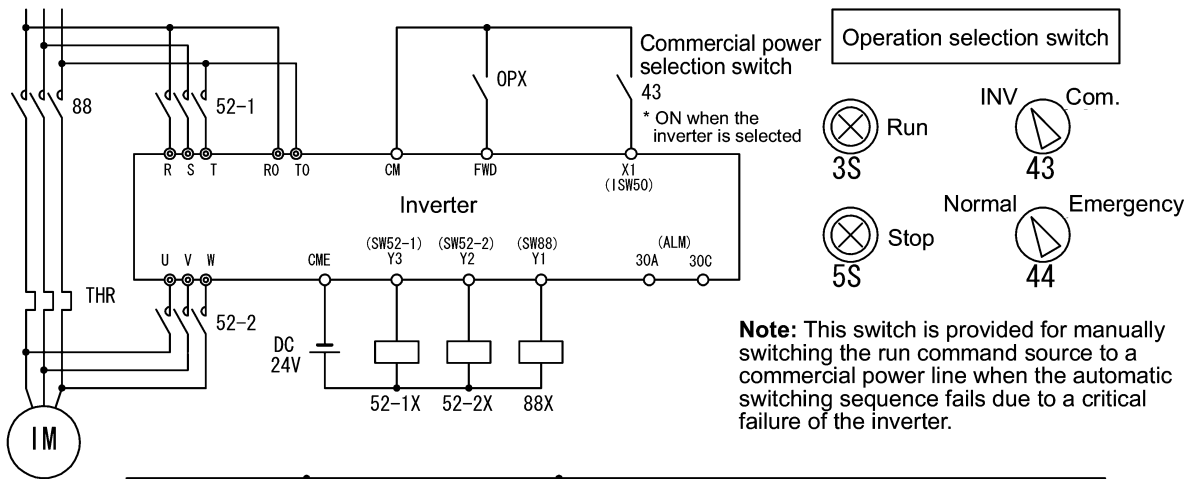

3) Sequence with an emergency switching function --Part 2 (Automatic switching by the alarm output issued by the inverter)

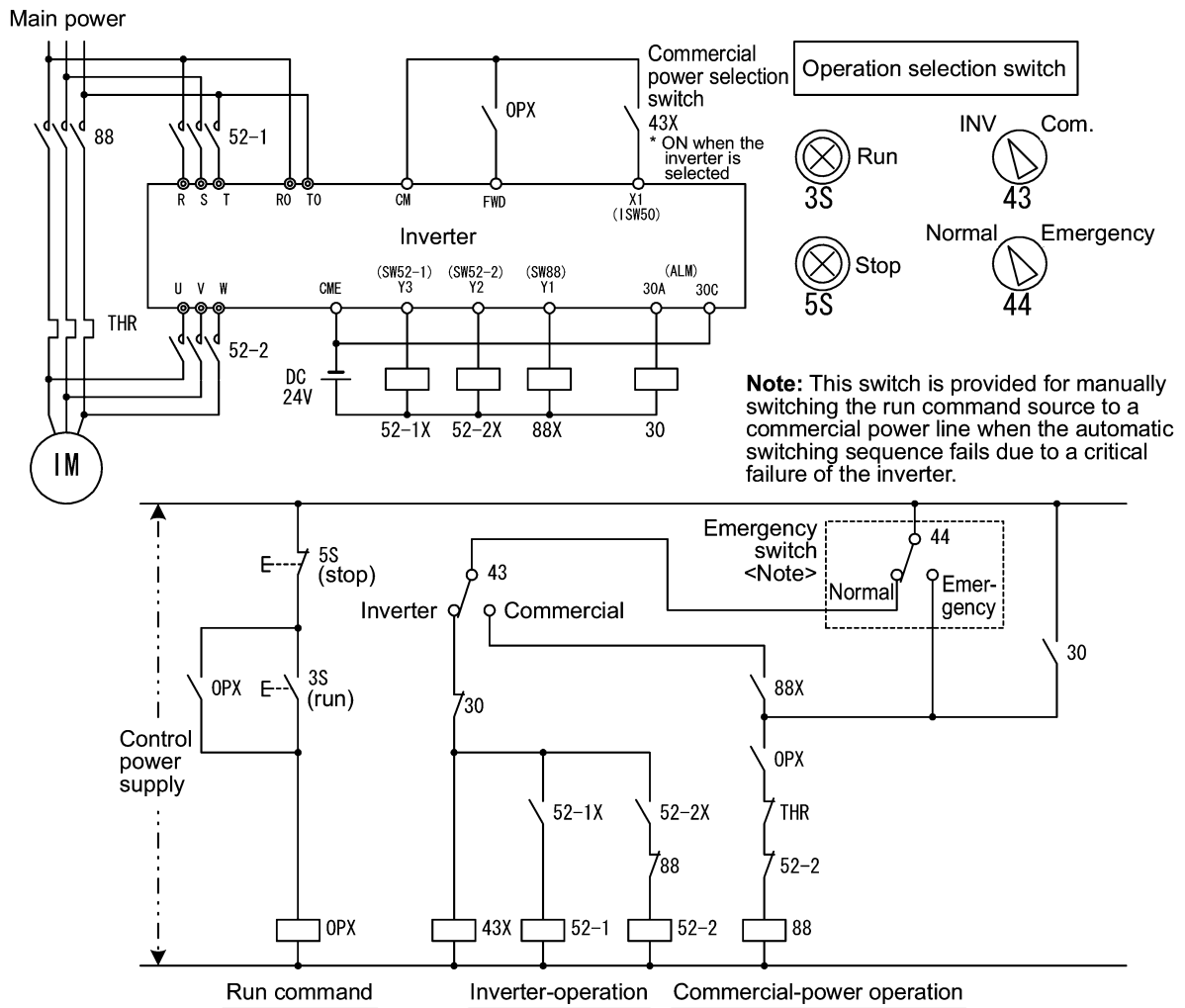

- Switch run command 2/1 -- (FR2/FR1)
Run forward 2 and Run reverse 2 -- (FWD2) and (REV2)
(Function code data = 87, 88 or 89)

These terminal commands switch the run command source. They are useful to switch the source between the digital input and the local keypad when the "Enable communications link" command (LE) and "Select local (keypad) operation" command (LOC) are turned OFF.

 Refer to Section 4.3 "Drive Command Generator" for details.

(FR2/FR1)	Run command source	
	Communications link disabled (Normal operation)	Communications link enabled
OFF	Follow the data of F02	Follow the data of S06 (FWD/REV)
ON	(FWD2) or (REV2)	Follow the data of S06 (FWD2/REV2)

Turning the (FWD2) command ON runs the motor forward, and turning the (REV2) command, reverse. Turning either of them OFF decelerates the motor to stop.

- Run forward -- (FWD)
(Function code data = 98)

Turning this terminal command ON runs the motor in the forward direction; turning it OFF decelerates it to stop.

 This terminal command can be assigned only by E98 or E99.

- Run reverse -- (REV)
(Function code data = 99)

Turning this terminal command ON runs the motor in the reverse direction; turning it OFF decelerates it to stop.

 This terminal command can be assigned only by E98 or E99.

E20 to E22 E24, E27	<p>Signal Assignment to [Y1] to [Y3] (Transistor signal)</p> <p>Signal Assignment to [Y5A/C] and [30A/B/C] (Relay contact signal)</p>
------------------------	---

E20 to E22, E24, and E27 assign output signals (listed on the next page) to general-purpose, programmable output terminals [Y1], [Y2], [Y3], [Y5A/C], and [30A/B/C]. These function codes can also switch the logic system between normal and negative to define the property of those output terminals so that the inverter logic can interpret either the ON or OFF status of each terminal as active. The factory default settings are "Active ON."

Terminals [Y1], [Y2], and [Y3] are transistor outputs and terminals [Y5A/C] and [30A/B/C] are relay contact outputs. In normal logic, if an alarm occurs, the relay will be energized so that [30A] and [30C] will be closed, and [30B] and [30C] opened. In negative logic, the relay will be deenergized so that [30A] and [30C] will be opened, and [30B] and [30C] closed. This may be useful for the implementation of failsafe power systems.

- Note**
- When a negative logic is employed, all output signals are active (e.g. an alarm would be recognized) while the inverter is powered OFF. To avoid causing system malfunctions by this, interlock these signals to keep them ON using an external power source. Furthermore, the validity of these output signals is not guaranteed for approximately 3 seconds after power-on, so introduce such a mechanism that masks them during the transient period.
 - Terminals [Y5A/C] and [30A/B/C] use mechanical contacts that cannot stand frequent ON/OFF switching. Where a frequent ON/OFF switching is anticipated (for example, limiting a current by using signals subjected to inverter output limit control such as switching to commercial power line), use transistor outputs [Y1] through [Y3] instead. The service life of a relay is approximately 200,000 times if it is switched on and off at one-second intervals.

The table below lists functions that can be assigned to terminals [Y1], [Y2], [Y3], [Y5A/C], and [30A/B/C].

To make the explanations simpler, the examples shown below are all written for the normal logic (Active ON.)

Function code data		Functions assigned	Symbol
Active ON	Active OFF		
0	1000	Inverter running	(RUN)
1	1001	Frequency arrival signal	(FAR)
2	1002	Frequency detected	(FDT)
3	1003	Undervoltage detected (Inverter stopped)	(LU)
5	1005	Inverter output limiting	(IOL)
6	1006	Auto-restarting after momentary power failure	(IPF)
7	1007	Motor overload early warning	(OL)
10	1010	Inverter ready to run	(RDY)
11	-	Switch motor drive source between commercial power and inverter output (For MC on commercial line)	(SW88)
12	-	Switch motor drive source between commercial power and inverter output (For secondary side)	(SW52-2)
13	-	Switch motor drive source between commercial power and inverter output (For primary side)	(SW52-1)
15	1015	Select AX terminal function (For MC on primary side)	(AX)
25	1025	Cooling fan in operation	(FAN)
26	1026	Auto-resetting	(TRY)
27	1027	Universal DO	(U-DO)
28	1028	Heat sink overheat early warning	(OH)
30	1030	Service life alarm	(LIFE)
33	1033	Command loss detected	(REF OFF)
35	1035	Inverter output on	(RUN2)
36	1036	Overload prevention control	(OLP)
37	1037	Current detected	(ID)
42	1042	PID alarm	(PID-ALM)
43	1043	Under PID control	(PID-CTL)
44	1044	Motor stopping due to slow flowrate under PID control	(PID-STP)
45	1045	Low output torque detected	(U-TL)
54	1054	Inverter in remote operation	(RMT)
55	1055	Run command activated	(AX2)
56	1056	Motor overheat detected (PTC)	(THM)
60	1060	Mount motor 1, inverter-driven	(M1_I)
61	1061	Mount motor 1, commercial-power-driven	(M1_L)
62	1062	Mount motor 2, inverter-driven	(M2_I)
63	1063	Mount motor 2, commercial-power-driven	(M2_L)
64	1064	Mount motor 3, inverter-driven	(M3_I)
65	1065	Mount motor 3, commercial-power-driven	(M3_L)
67	1067	Mount motor 4, commercial-power-driven	(M4_L)
68	1068	Periodic switching early warning	(MCHG)
69	1069	Pump control limit signal	(MLIM)
99	1099	Alarm output (for any alarm)	(ALM)

 A mark "-" in the Active OFF column means that a negative logic cannot be applied to the terminal function.

- Inverter running -- (RUN)
(Function code data = 0)

This output signal is used to tell the external equipment that the inverter is running at a starting frequency or higher. It comes ON when the output frequency exceeds the starting frequency, and it goes OFF when it is less than the stop frequency. It is also OFF when the DC braking is in operation.

If this signal is assigned in negative logic (Active OFF), it can be used as a signal indicating "inverter being stopped."

- Frequency arrival signal -- (FAR)
(Function code data = 1)

This output signal comes ON when the difference between the output frequency and reference frequency comes within the allowable error zone. (prefixed to 2.5 Hz).

- Frequency detected -- (FDT)
(Function code data = 2)

This output signal comes ON when the output frequency exceeds the frequency detection level specified by function code E31, and it goes OFF when the output frequency drops below the "Detection level - 1 Hz (hysteresis band of frequency comparator: prefixed at 1 Hz)."

- Undervoltage detected -- (LU)
(Function code data = 3)

This output signal comes ON when the DC link bus voltage of the inverter drops below the specified undervoltage level, and it goes OFF when the voltage exceeds the level.

This signal is ON also when the undervoltage protective function is activated so that the motor is in an abnormal stop state (e.g., tripped).

When this signal is ON, a run command is disabled if given.

- Inverter output limiting -- (IOL)
(Function code data = 5)

This output signal comes ON when the inverter is limiting the output frequency by activating any of the following actions (minimum width of the output signal: 100 ms).

- Current limiting by software (F43 and F44: Current limiter (Mode selection) and (Level))
- Instantaneous overcurrent limiting by hardware (H12 = 1)
- Automatic deceleration (H69 = 3)

 When the (IOL) signal is ON, it may mean that the output frequency may have deviated from (or dropped below) the frequency specified by the frequency command because of this limiting function.

- Auto-restarting after momentary power failure -- (IPF)
(Function code data = 6)

This output signal is ON either during continuous running after a momentary power failure or during the period from when the inverter has detected an undervoltage condition and shut down the output until restart has been completed (the output has reached the reference frequency).

To enable this (IPF) signal, set F14 (Restart mode after momentary power failure) to "3: Enable restart (Continue to run)," "4: Enable restart (Restart at the frequency at which the power failure occurred)," or "5: Enable restart (Restart at the starting frequency)" beforehand.

■ Motor overload early warning -- (OL)
(Function code data = 7)

This output signal is used to issue a motor overload early warning that enables you to take an corrective action before the inverter detects a motor overload alarm \overline{OL} and shuts down its output.

This signal comes ON when the current exceeds the level specified by E34 (Overload early warning).

Note Function code E34 is effective for not only the (OL) signal, but also for the "Current detected" signal (ID).

■ Inverter ready to run -- (RDY)
(Function code data = 10)

This output signal comes ON when the inverter becomes ready to run by completing hardware preparation (such as initial charging of DC link bus capacitors and initialization of the control circuit) and no protective functions are activated.

■ Switch motor drive source between commercial power and inverter output -- (SW88), (SW52-2) and (SW52-1)
(Function code data = 11, 12, 13)

Assigning these output signals to transistor output terminals [Y1], [Y2] and [Y3] enables an (ISW5) or (ISW60) terminal command that controls the magnetic contactor for switching the motor drive source between the commercial power and the inverter output according to the integrated sequence.

For details, refer to the description and diagrams of the (ISW50) and (ISW60) terminal commands.

■ Select AX terminal function -- (AX)
(Function code data = 15)

In response to a run command (FWD), this output signal controls the magnetic contactor on the commercial-power supply side. It comes ON when the inverter receives a run command and it goes OFF after the motor decelerates to stop because of a stop command received.

This signal immediately goes OFF upon receipt of a coast-to-stop command or when an alarm occurs.

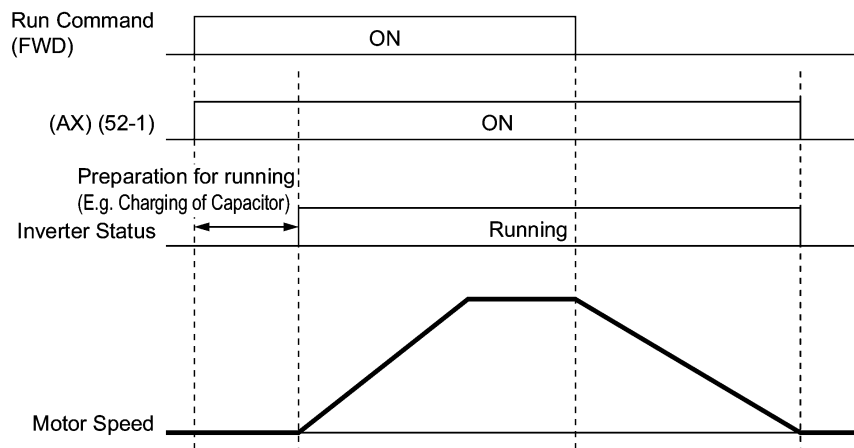
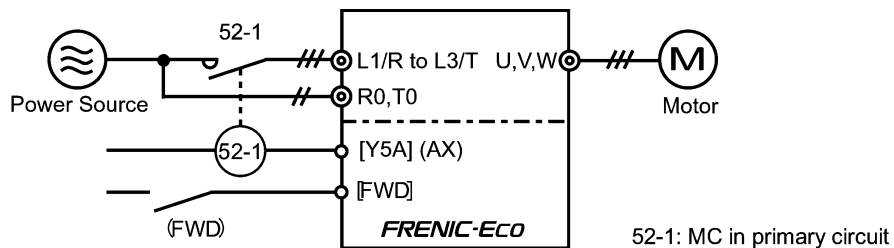

- Cooling fan in operation -- (FAN)
(Function code data = 25)

Under the cooling fan ON/OFF control enabled (H06 = 1), this output signal is ON when the cooling fan is in operation, and OFF when it is stopped. This signal can be used to make the cooling system of peripheral equipment interlocked for an ON/OFF control.

- Auto-resetting -- (TRY)
(Function code data = 26)

This output signal comes ON when auto resetting is in progress. The auto-resetting is specified by H04 and H05 (Auto-resetting). Refer to function codes H04 and H05 for details about the number of resetting times and reset interval.

- Universal DO -- (U-DO)
(Function code data = 27)

Assigning this output signal to an inverter's output terminal and connecting the terminal to a digital input terminal of peripheral equipment via the RS-485 communications link or the field bus, allows the inverter to send commands to the peripheral equipment.

The universal DO can be used as an output signal independent of the inverter operation.

 For the procedure for access to Universal DO via the RS-485 communications link or field bus, refer to the respective instruction manual.

- Heat sink overheat early warning -- (OH)
(Function code data = 28)

This output signal is used to issue a heat sink overheat early warning that enables you to take a corrective action before an overheat trip \overline{OH} / actually happens.

This signal comes ON when the temperature of the heat sink exceeds the "overheat trip \overline{OH} / temperature minus 5°C," and it goes OFF when it drops down to the "overheat trip \overline{OH} / temperature minus 8°C."

This signal comes ON also when the internal air circulation DC fan (45 kW or above for 200 V class series or 55 kW or above for 400 V class series) has locked.

- Service life alarm -- (LIFE)
(Function code data = 30)

This output signal comes ON when it is judged that the service life of any one of capacitors (reservoir capacitor in the DC link bus and electrolytic capacitors on the printed circuit board) and cooling fan has expired.

This signal comes ON also when the internal air circulation DC fan (45 kW or above for 200 V class series or 55 kW or above for 400 V class series) has locked.

This signal should be used as a guide for replacement of the capacitors and cooling fan. If this signal comes ON, use the specified maintenance procedure to check the service life of these parts and determine whether the parts should be replaced or not.

 For details, refer to the FRENIC-Eco Instruction Manual (INR-SI47-1059-E), Section 7.3, Table 7.3 "Criteria for Issuing a Lifetime Alarm."

- Command loss detected -- (REF OFF)
(Function code data = 33)

This output signal comes ON when an analog input used as a frequency command source is in a command loss state (as specified by E65) due to a wire break or a weak connection. This signal goes OFF when the operation under the analog input is resumed.

 For details of the command loss detection, refer to the descriptions of function code E65.

-
- Inverter output on -- (RUN2)
(Function code data = 35)

This output signal comes ON when the inverter is running at the starting frequency or below or the DC braking is in operation.

- Overload prevention control -- (OLP)
(Function code data = 36)

This output signal comes ON when the overload prevention control is activated. The minimum ON-duration is 100 ms.



For details of the overload prevention control, refer to the descriptions of function code H70.

- Current detected -- (ID)
(Function code data = 37)

This output signal comes ON when the output current of the inverter exceeds the level specified by E34 (Current detection (Level)) for the time longer than the one specified by E35 (Current detection (Timer)). The minimum ON-duration is 100 ms.

This signal goes OFF when the output current drops below 90% of the rated operation level.



Function code E34 is effective for not only the motor overload early warning (OL), but also for the operation level of the current detection (ID).



For details of the current detection, refer to the descriptions of function codes E34 and E35.

- PID alarm -- (PID-ALM)
(Function code data = 42)

Assigning this output signal enables PID control specified by function codes J11 through J13 to output absolute-value alarm and deviation alarm.



For details of the PID alarm, refer to the descriptions of function codes J11 through J13.

- Under PID control -- (PID-CTL)
(Function code data = 43)

This output signal comes ON when PID control is enabled ("Cancel PID control" (Hz/PID) = OFF) and a run command is ON.



Under PID control, the inverter may stop due to the slow flowrate stopping function or other reasons, with the (PID-CTR) signal being ON. As long as the (PID-CTL) signal is ON, PID control is effective, so the inverter may abruptly resume its operation, depending on the feedback value in PID control.

WARNING

When PID control is enabled, the inverter may stop its output during operation because of sensor signals or for some other reasons. In such cases, operation will resume automatically.

Design your machinery so that safety is ensured even in such cases.

Otherwise, an accident could occur.



For details of PID control, refer to the description of function codes J01 or later.

- Motor stopping due to slow flowrate under PID control -- (PID-STP)
(Function code data = 44)

This output signal is ON when the inverter is in a stopped state due to the slow flowrate stopping function under PID control.

 For details of the slow flowrate stopping function during PID control, refer to the description of function codes J15 through J17.

- Low output torque detected -- (U-TL)
(Function code data = 45)

This output signal comes ON when the torque value calculated by the inverter decreases below the level specified by E80 (Detect low torque (Detection level)) for the time longer than the one specified by E81 (Detect low torque (Timer)). The minimum ON-duration is 100 ms.

 For details of the low output torque detection, refer to the description of function codes E80 and E81.

- Inverter in remote operation -- (RMT)
(Function code data = 54)

This output signal comes ON when the inverter switches from local to remote mode.

 For details about the remote and local modes, refer to Section 3.2.3 "[Switching between remote and local modes.](#)"

- Run command activated -- (AX2)
(Function code data = 55)

Assigning a "Enable to run" command (RE) to a digital input terminal prevents the inverter from starting to run upon receipt of a run command only. If the inverter receives a run command, it readies itself for running and outputs this status signal (AX2). At this status, turning the (RE) command ON causes the inverter to actually start running.

 For details about the "Enable to run" command (RE) and "Run command activated" signal (AX2), refer to the description of (RE) (data = 38) for function codes E01 through E05.

- Motor overheat detected (PTC) -- (THM)
(Function code data = 56)

This output signal indicates that a temperature alarm condition has been detected by a PTC (Positive Temperature Coefficient) thermistor on the motor.

With this output signal assigned, setting function code H26 (PTC thermistor) to "2" enables the inverter to continue running instead of stopping with the alarm  even if a temperature alarm condition has been detected.

 For details of the PTC thermistor, refer to the description of function codes H26 and H27.

- Alarm output (for any alarm) -- (ALM)
(Function code data = 99)

This output signal comes ON if any of the protective functions is activated and the inverter enters Alarm mode.

E31	Frequency Detection (FDT) (Detection level)
E32	Frequency Detection (FDT) (Hysteresis width)

When the output frequency has exceeded the frequency detection level specified by E31, the FDT signal comes ON; when it has dropped below the "frequency detection level (E31) minus hysteresis width (E32)," it goes OFF.

You need to assign (FDT) (Frequency detection: data = 2) to one of digital output terminals.

- Data setting range: 0.0 to 120.0 (Hz)

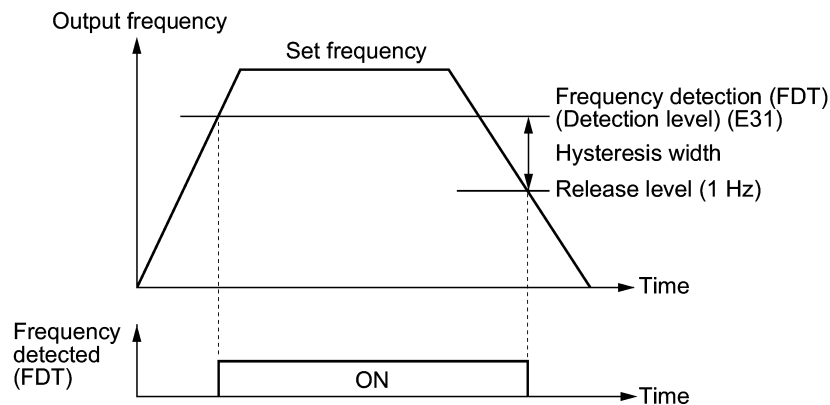

E34	Overload Early Warning/Current Detection (Level)
E35	Overload Early Warning/Current Detection (Timer)

E34 and E35 specify, in conjunction with output terminal signals (OL) and (ID), the level and duration of overload and current beyond which an early warning or an alarm will be issued.

■ Overload Early Warning

The warning signal (OL) is used to detect a symptom of an overload condition (alarm code \overline{OL} / \overline{I}) of the motor so that the user can take an appropriate action before the alarm actually happens. The signal turns on when the current level specified by E34 (Overload early warning) is exceeded. In typical cases, set E34 to 80-90% against data of F11 (Electronic thermal overload protection for motor (Overload detection level)). Specify also the thermal characteristics of the motor with F10 (Electronic thermal overload protection for motor (Select motor characteristics)) and F12 (Electronic thermal overload protection for motor (Thermal time constant)). To utilize this feature, you need to assign (OL) (Motor overload early warning) (data = 7) to any of the digital output terminals.

■ Current Detection

The signal (ID) turns on when the output current of the inverter has exceeded the level specified by E34 (Current detection (Level)) and the output current continues longer than the period specified by E35 (Current detection (Timer)). The signal turns off when the output current drops below 90% of the rated operation level. (Minimum width of the output signal: 100 ms)

To utilize this feature, you need to assign (ID) (Current detection) (data = 37) to any of digital output terminals.

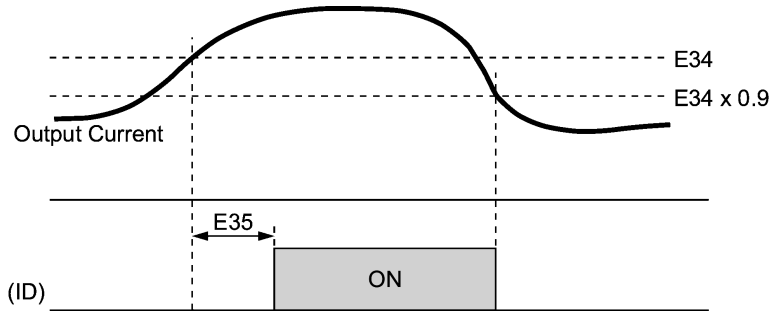

- Data setting range (E34): Current value of 1 to 150% of the rated inverter current in units of amperes. (0: disable)
- Data setting range (E35): 0.01 to 600.00 (sec.)

E40	PID Display Coefficient A
E41	PID Display Coefficient B

These function codes provide display coefficients to convert the PID process command, PID feedback value, or analog input monitor in easy-to-understand mnemonic physical quantities to display.

- Data setting range: -999 to 0.00 to 9990 for the display coefficients A and B.

■ Display coefficients of PID process command and PID feedback value

The PID display coefficients A and B convert the PID process command and the PID feedback value into mnemonic quantities before they are displayed. E40 specifies the PID display coefficient A (display of the value at 100% of the PID process command or PID feedback value); and E41 specifies the PID display coefficient B (display of the value at 0% of the PID process command or PID feedback value).

The value displayed is determined as follows:

$$\text{Value displayed} = (\text{PID process command or PID feedback value (\%)} / 100) \times (\text{display coefficient A} - \text{B}) + \text{B}$$

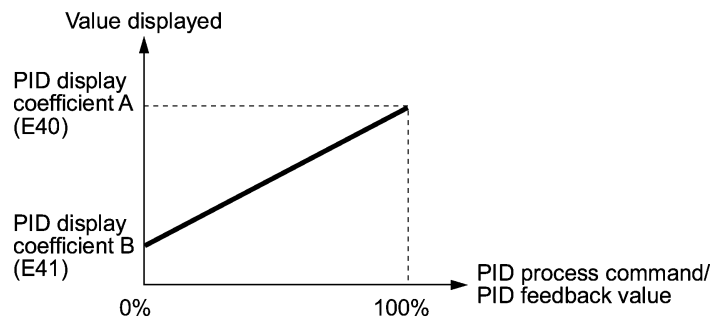

Example

You wish to maintain the pressure around 16 kPa (sensor voltage 3.13 V) while the pressure sensor can detect 0 - 30 kPa over the output voltage range of 1 - 5 V.

Select the terminal [12] as the feedback terminal and set the gain to 200% so that 5V corresponds to 100%.

By setting:

"Display at 100% of PID process command & PID feedback value = Display coefficient E40 = 30.0" and

"Display at 0% of PID process command & PID feedback value = Display coefficient E41 = -7.5,"

you can have the monitor and the setting on the keypad of the value of the PID process command and PID feedback value recognized as the pressure.

If you wish to control the pressure at 16 kPa on the keypad, set the value to 16.0.

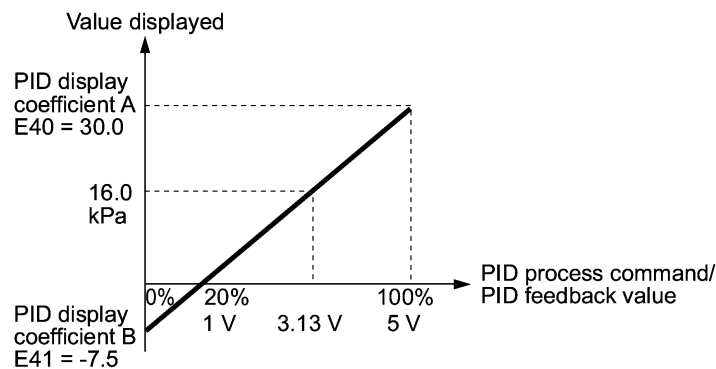

For details of PID control, refer to the description of function codes J01 and later.



For the method to display the PID process command and PID feedback value, refer to the description of function code E43.

■ Display coefficient of analog input monitor

By inputting analog signals from various sensors such as temperature sensors in air conditioners to the inverter, you can monitor the state of peripheral devices via the communications link. By using an appropriate display coefficient, you can also have various values converted into physical values such as temperature and pressure before being displayed.

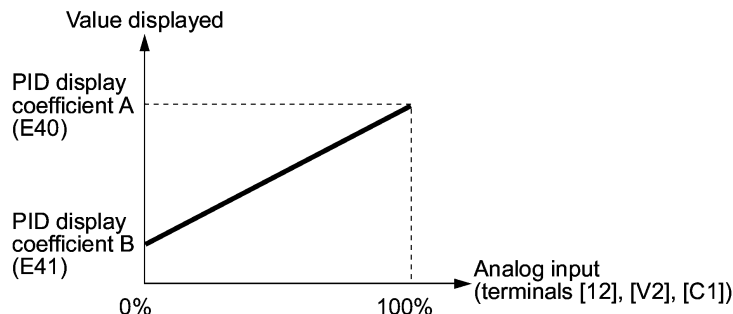

To set up the analog input monitor, use function codes E61 through E63. Use E43 to choose the item to be displayed.

E43	LED Monitor (Item selection)	Refer to E48.
------------	-------------------------------------	----------------------

E43 specifies the monitoring item to be displayed on the LED monitor.

Data for E43	Function (Displays the following.)	Description
0	Speed monitor	Selected by the sub item of function code E48
3	Output current	Inverter output current expressed in RMS (A)
4	Output voltage	Inverter output voltage expressed in RMS (V)
8	Calculated torque	Output torque of the motor (%)
9	Input power	Inverter's input power (kW)
10	PID process command value (frequency) *	Refer to function codes E40 and E41.
12	PID feedback value *	Refer to function codes E40 and E41.
14	PID output value *	100% at maximum frequency
15	Load factor	Inverter's load factor (%)
16	Motor output	Motor output (kW)
17	Analog input	Refer to function codes E40 and E41

* If 0 (Disable) is set for function code J01, "- - -" appears on the LED monitor.

Specifying the speed monitor with E43 provides a choice of speed-monitoring formats selectable with E48 (LED Monitor).

Define the speed-monitoring format on the LED monitor as listed below.

Data for E48	Display format of the sub item	
0	Output frequency	Expressed in Hz
3	Motor speed in r/min	$120 \div \text{Number of poles (P01)} \times \text{Frequency (Hz)}$
4	Load shaft speed in r/min	Coefficient for speed display (E50) \times Frequency (Hz)
7	Speed in %	100% at maximum frequency (F03)

E45

LCD Monitor (Item selection)

E45 specifies the mode of the LCD display during running mode using the multi-function keypad.

Data for E45	Function
0	Running status, rotational direction and operation guide
1	Bar charts for output frequency, current and calculated torque

Example of display for E45 = 0 (during running)

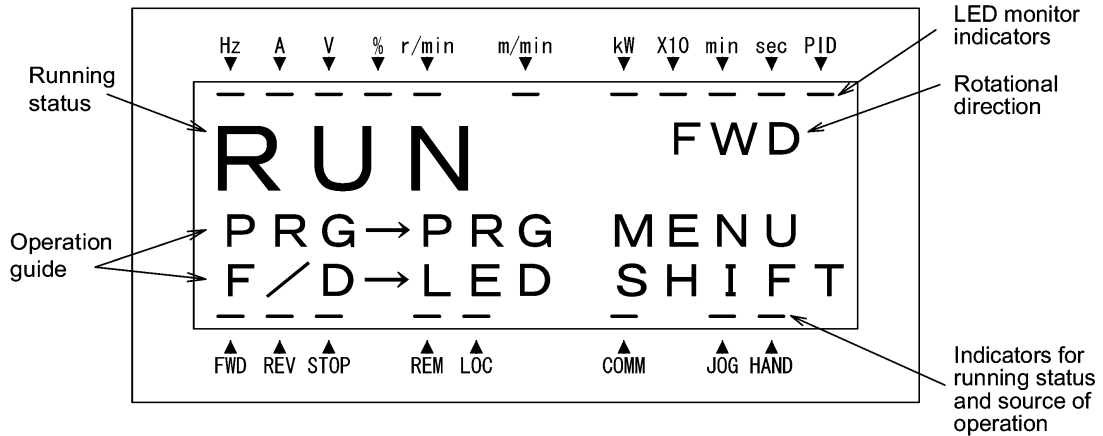

Example of display for E45 = 1 (during running)

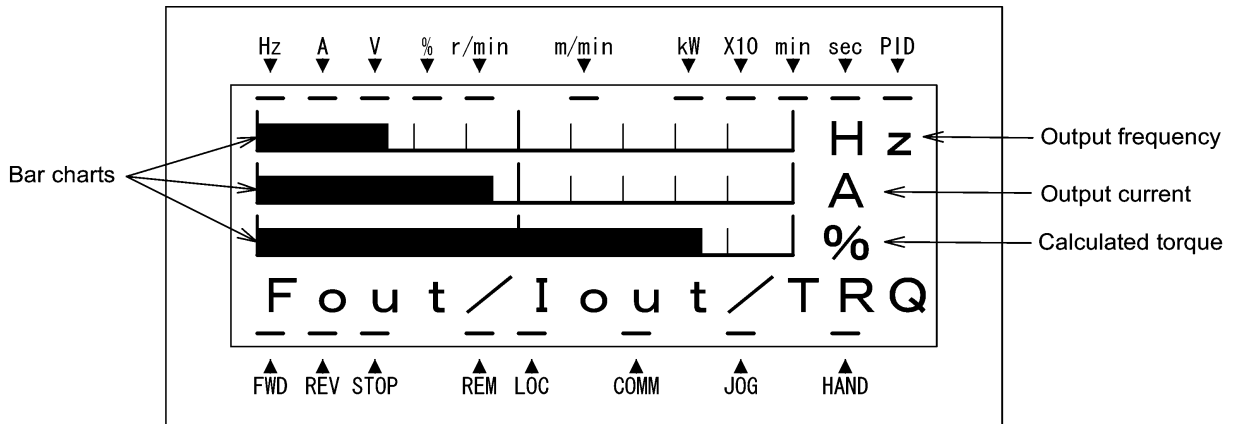

Full-scale values on bar charts

Item displayed	Full scale
Output frequency	Maximum frequency (F03)
Output current	Inverter's rated current × 200%
Calculated torque	Motor's rated torque × 200%

E46**LCD Monitor (Language selection)**

E46 specifies the language to display on the multi-function keypad as follows:

Data for E46	Language
0	Japanese
1	English
2	German
3	French
4	Spanish
5	Italian

E47**LCD Monitor (Contrast control)**

Adjusts the contrast of the LCD monitor on the multi-function keypad as follows:

Data for E47	0, 1, 2, 3, 4, 5, 6, 7, 8, 9, 10
Contrast	Low \longleftrightarrow High

E48**LED Monitor (Speed monitor item)****Refer to E43.**

For how to set this function code, refer to the description of function code E43.

E50**Coefficient for Speed Indication**

Use this coefficient for displaying the load shaft speed on the LED monitor (refer to function code E43).

■ Load shaft speed

The load shaft speed is displayed as $E50 \text{ (Coefficient for speed indication)} \times \text{Frequency (Hz)}$.

E51**Display Coefficient for Input Watt-hour Data**

Use this coefficient (multiplication factor) for displaying the input watt-hour data ($\overline{5}$ \overline{H}) in a part of maintenance information on the keypad.

The input watt-hour data will be displayed as follows:

$E51 \text{ (Coefficient for input watt-hour data)} \times \text{Input watt-hour (kWh)}$

 **Note** Setting E51 data to 0.000 clears the input watt-hour and its data to "0." After clearing, be sure to restore E51 data to the previous display coefficient; otherwise, input watt-hour data will not be accumulated.

 For the procedure for viewing maintenance information, refer to Chapter 3 "OPERATION USING THE KEYPAD."

E52

Keypad (Menu display mode)

E52 specifies the menu display mode on the standard keypad as shown in the table below.

Menu	Menu	LED monitor shows:	Main functions
#0	"Quick Setup"	<i>Q.F.T.C</i>	Displays only basic function codes to customize the inverter operation.
#1	"Data Setting"	<i>F--</i>	F codes (Fundamental functions)
		<i>E--</i>	E codes (Extension terminal functions)
		<i>C--</i>	C codes (Control functions of frequency)
		<i>P--</i>	P codes (Motor parameters)
		<i>H--</i>	H codes (High performance functions)
		<i>J--</i>	J codes (Application functions)
		<i>y--</i>	y codes (Link functions)
		<i>o--</i>	o code (Optional function) (Note)
Selecting each of these function codes enables its data to be displayed/changed.			
#2	"Data Checking"	<i>C.R.E.P</i>	Displays only function codes that have been changed from their factory defaults. You can refer to or change those function code data.
#3	"Drive Monitoring"	<i>D.R.P.E</i>	Displays the running information required for maintenance or test running.
#4	"I/O Checking"	<i>I.O.C</i>	Displays external interface information.
#5	"Maintenance Information"	<i>M.I.N.F</i>	Displays maintenance information including accumulated run time.
#6	"Alarm Information"	<i>A.L.M</i>	Displays the latest four alarm codes. You can refer to the running information at the time when the alarm occurred.
#7	"Data Copying"	<i>D.C.P.Y</i>	Allows you to read or write function code data, as well as verifying it.

(Note) An o code appears only when any option is mounted on the inverter. For details, refer to the instruction manual of the corresponding option.



For details of each menu item, refer to Chapter 3 "OPERATION USING THE KEYPAD."

The setting of function code E52 determines the menu to be displayed as follows:

Data for E52	Mode	Menu to be displayed
0	Function code data editing mode	Menus #0, #1 and #7
1	Function code data check mode	Menus #2 and #7
2	Full-menu mode	Menus #0 #7



The multi-function keypad always displays all the menu items (including additional menu items) regardless of the E52 data.

E61	Analog Input for [12] (Extension function selection)
E62	Analog Input for [C1] (Extension function selection)
E63	Analog Input for [V2] (Extension function selection)

E61, E62, and E63 define the function of the terminals [12], [C1], and [V2], respectively.



There is no need to set up these terminals if they are to be used for frequency command sources.





Data for E61, E62, or E63	Input assigned to [12], [C1] and [V2]	Description
0	None	--
1	Auxiliary frequency command 1*	Auxiliary frequency input to be added to the reference frequency given by frequency command 1 (F01). Will not be added to any other reference frequency given by such as frequency command 2 and multistep frequency commands.
2	Auxiliary frequency command 2*	Auxiliary frequency to be added to all reference frequencies given by frequency command 1, frequency command 2, multistep frequency commands, etc.
3	PID process command 1	Inputs process command sources such as temperature and pressure under PID control. You also need to set function code J02.
5	PID feedback value	Inputs feedback values such as temperature and pressure under PID control.
20	Analog signal input monitor	By inputting analog signals from various sensors such as the temperature sensors in air conditioners to the inverter, you can monitor the state of external devices via the communications link. By using an appropriate display coefficient, you can also have various values to be converted into physical values such as temperature and pressure before being displayed.

* For details, refer to Section 4.2 "Drive Frequency Command Generator."

Note If these terminals have been set up to have the same data, the operation priority is given in the following order:
E61 > E62 > E63

E64	Saving Digital Reference Frequency
------------	---

E64 specifies how to save the reference frequency specified in digital formats by the   keys on the keypad as shown below.

Data for E64	Function
0	Auto saving (at the time of main power turned off) The reference frequency will be automatically saved when the main power is turned off. At the next power-on, the reference frequency at the time of the previous power-off applies.
1	Saving by pressing  key Pressing the  key saves the reference frequency. If the control power is turned off without pressing the  key, the data will be lost. At the next power-on, the inverter uses the reference frequency saved when the  key was pressed last.

E65**Command Loss Detection (Level)**

When the analog frequency command (by frequency setting through terminals [12], [C1], and [V2]) has dropped below 10% of the expected frequency command within 400 ms, the inverter presumes that the analog frequency command wire has been broken and continues its operation at the frequency determined by the ratio specified by E65 to the reference frequency. When the frequency command level (in voltage or current) returns to a level higher than that specified by E65, the inverter presumes that the broken wire has been fixed and continues to run following the frequency command.

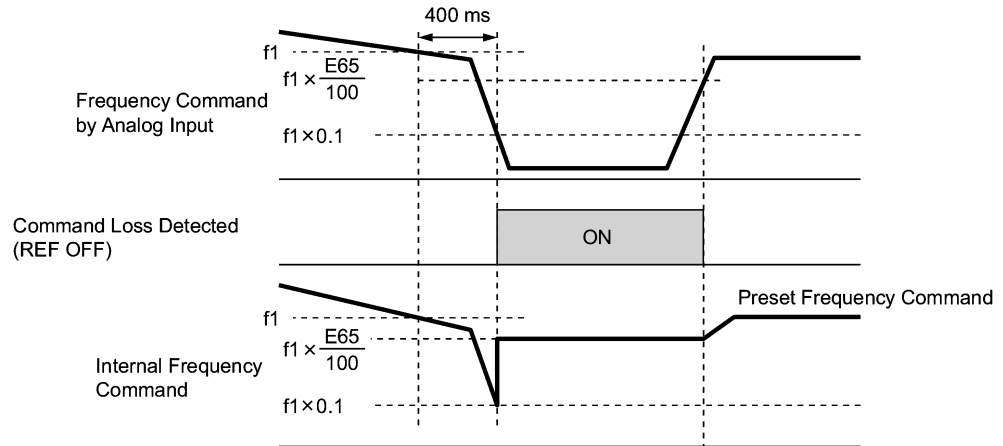

In the diagram above, f_1 is the level of the analog frequency command sampled at any given time. The sampling is repeated at regular intervals to continually monitor the wiring connection of the analog frequency command.

- Note** Avoid an abrupt voltage or current change for the analog frequency command. The abrupt change may be interpreted as a wire break.
- Setting E65 data at "999" (Disable) allows the "Reference loss detected" signal (REF OFF) to be issued, but does not allow the reference frequency to change (the inverter runs at the analog frequency command as specified).
- When E65 = "0" or "999," the reference frequency level at which the broken wire is recognized as fixed is " $f_1 \times 0.2$."
- When E65 = "100" (%) or higher, the reference frequency level at which the broken wire is recognized as fixed is " $f_1 \times 1$."
- The reference loss detection is not affected by the setting of analog input adjustment (filter time constants: C33, C38, and C43).

E80	Detect Low Torque (Detection level)
E81	Detect Low Torque (Timer)

The signal (U-TL) turns on when the torque calculated by the inverter with reference to its output current has dropped below the level specified by E80 for the time longer than the one specified by E81. The signal turns off when the calculated torque exceeds the level specified by $E80 + 5\%$. The minimum width of output signal is 100 ms.

You need to assign the "Low output torque detected" signal (U-TL) (data = 45) to the general-purpose output terminals.

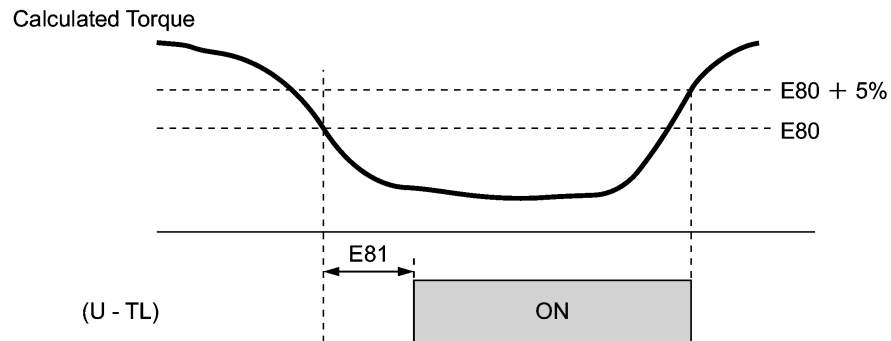

The detection level is set so that 100% corresponds to the rated torque of the motor.

In the inverter's low frequency operation, as a substantial error in torque calculation occurs, no low torque can be detected within the operation range at less than 20% of the base frequency (F04). (In this case, the result of recognition before entering this operation range is retained.)

The (U-TL) signal goes off when the inverter is stopped.

Since the motor parameters are used in the calculation of torque, it is recommended that auto-tuning be applied by function code P04 to achieve higher accuracy.

E98	Command Assignment to [FWD]	(Refer to E01 to E05.)
E99	Command Assignment to [REV]	(Refer to E01 to E05.)

For details of the command assignment to terminals [FWD] and [REV], refer to the descriptions for function codes E01 to E05.

9.2.3 C codes (Control functions of frequency)

C01 to C03	Jump Frequency 1, 2 and 3
C04	Jump Frequency (Band)

These function codes enable the inverter to jump over three different points on the output frequency in order to skip resonance caused by the motor speed and natural frequency of the driven machinery.

- While you are increasing the reference frequency, the moment the reference frequency reaches the bottom of the jump frequency band, the inverter keeps the output at that bottom frequency. When the reference frequency exceeds the upper limit of the jump frequency band, the internal reference frequency takes on the value of the reference frequency. When you are decreasing the reference frequency, the situation will be reversed.
- When more than two jump frequency bands overlap, the inverter actually takes the lowest frequency within the overlapped bands as the bottom frequency and the highest as the upper limit. Refer to the figure on the lower right.

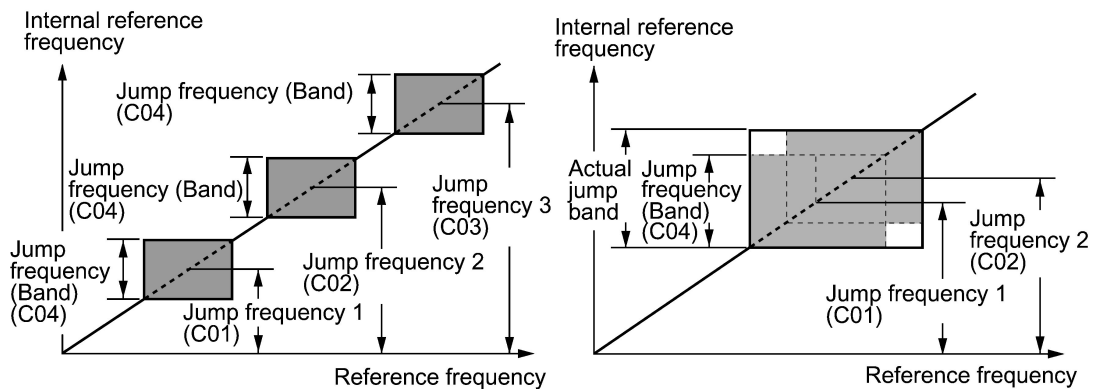

■ Jump frequencies 1, 2 and 3 (C01, C02 and C03)

Specify the center of the jump frequency band.

- Data setting range: 0.0 to 120.0 (Hz) (Setting to 0.0 results in no jump band.)

■ Jump frequency band (C04)

Specify the jump frequency band.

- Data setting range: 0.0 to 30.0 (Hz) (Setting to 0.0 results in no jump band.)

C05 to C11**Multistep Frequency 1 to 7**

- These function codes specify 7 frequencies required for driving the motor at frequencies 1 to 7.

Turning terminal commands (SS1), (SS2) and (SS4) ON/OFF selectively switches the reference frequency of the inverter in 7 steps. For details of the terminal function assignment, refer to the descriptions for function codes E01 to E05 "Command assignment to [X1] to [X5]."

- Data setting range: 0.00 to 120.00 (Hz)

The combination of (SS1), (SS2), and (SS4) and the selected frequencies are as follows.

(SS4)	(SS2)	(SS1)	Selected frequency command
OFF	OFF	OFF	Other than multistep frequency *
OFF	OFF	ON	C05 (multistep frequency 1)
OFF	ON	OFF	C06 (multistep frequency 2)
OFF	ON	ON	C07 (multistep frequency 3)
ON	OFF	OFF	C08 (multistep frequency 4)
ON	OFF	ON	C09 (multistep frequency 5)
ON	ON	OFF	C10 (multistep frequency 6)
ON	ON	ON	C11 (multistep frequency 7)

* "Other than multi-frequency" includes frequency command 1 (F01), frequency command 2 (C30) and other command sources except multi-frequency commands.

To use these features, you need to assign multistep frequency selections (SS1), (SS2), and (SS4) (data = 0, 1, 2) to the digital input terminals.



For the relationship between multistep frequency operation and other frequency commands, refer to Section 4.2 "Drive Frequency Command Generator."

■ To enable PID control (J01 = 1 or 2)

You can set the process command in PID control as the preset value (multistep frequency 1). You can also use multistep frequency (multistep frequency 3) for manual speed command during disabling of PID control ((Hz/PID) = ON).

• Process Command

(SS4)	(SS2)	(SS1)	Frequency Command
OFF	—	—	Process command by J02
ON	—	—	Multistep frequency by C08

You can set C08 in increments of 1 Hz. The following formula can be used to convert a value of the process command to the C08 data and vice versa:

$$\text{C08 data} = \text{Process command (\%)} \times \text{Maximum frequency (F03)} \div 100$$

• Manual speed command

(SS4)	(SS2)	(SS1)	Selected frequency
—	OFF	OFF	Other than multistep frequency
—	OFF	ON	C05 (Multistep frequency 1)
—	ON	OFF	C06 (Multistep frequency 2)
—	ON	ON	C07 (Multistep frequency 3)

 For PID process commands, refer to the block diagram in Section 4.8 "PID Frequency Command Generator."

C30	Frequency Command 2	(Refer to F01.)
------------	----------------------------	------------------------

For details of frequency command 2, refer to the description of function code F01.

C32	Analog Input Adjustment for [12] (Gain)	(Refer to F18.)
------------	--	------------------------

C34	Analog Input Adjustment for [12] (Gain reference point)	(Refer to F18.)
------------	--	------------------------

C37	Analog Input Adjustment for [C1] (Gain)	(Refer to F18.)
------------	--	------------------------

C39	Analog Input Adjustment for [C1] (Gain reference point)	(Refer to F18.)
------------	--	------------------------

C42	Analog Input Adjustment for [V2] (Gain)	(Refer to F18.)
------------	--	------------------------

C44	Analog Input Adjustment for [V2] (Gain reference point)	(Refer to F18.)
------------	--	------------------------

For details of analog input commands, refer to the description of function code F18.

C33	Analog Input Adjustment for [12] (Filter time constant)
C38	Analog Input Adjustment for [C1] (Filter time constant)
C43	Analog Input Adjustment for [V2] (Filter time constant)

These function codes provide the filter time constants for the voltage and current of the analog input at terminals [12], [C1], and [V2]. Choose appropriate values for the time constants considering the response speed of the mechanical system as large time constants slow down the response. In case the input voltage fluctuates because of noise, specify large time constants.

- Data setting range: 0.00 to 5.00 (sec.)

C50	Bias Reference Point (Frequency command 1) (Refer to F18.)
------------	---

For details of setting the bias reference point for frequency command 1, refer to the descriptions of function code F18.

C51	Bias for PID command 1 (Bias value)
C52	Bias for PID command 1 (Bias reference point)

These function codes specify the bias and bias reference point of the analog PID process command 1 to enable defining arbitrary relationship between the analog input and PID process commands.



The actual setting is the same as that of function code F18. For details, refer to the description of function code F18.



Note that function codes C32, C34, C37, C39, C42, and C44 are shared by the frequency commands.

- Bias value (C51)
 - Data setting range: -100.00 to 100.00 (%)
- Bias reference point (C52)
 - Data setting range: 0.00 to 100.00 (%)

C53	Selection of Normal/Inverse Operation (Frequency command 1)
------------	--

C53 switches the reference frequency given by frequency command 1 (F01) between normal and inverse.



For details, refer to the description of "Switch normal/inverse operation" command (IVS) (data = 21) for function codes E01 through E05.

9.2.4 P codes (Motor parameters)

P01	Motor (No. of poles)
------------	-----------------------------

P01 specifies the number of poles of the motor. Enter the value shown on the nameplate of the motor. This setting is used to display the motor speed on the LED monitor (refer to function code E43). The following formula is used for the conversion.

$$\text{Motor speed (r/min)} = \frac{120}{\text{No. of poles}} \times \text{Frequency (Hz)}$$

P02	Motor (Rated capacity)
------------	-------------------------------

P02 specifies the rated capacity of the motor. Enter the rated value shown on the nameplate of the motor.

Data for P02	Unit	Dependency on function code P99
0.01 to 1000	kW	P99 = 0, 3 or 4
	HP	P99 = 1

P03	Motor (Rated current)
------------	------------------------------

P03 specifies the rated current of the motor. Enter the rated value shown on the nameplate of the motor.

- Data setting range: 0.00 to 2000 (A)

P04	Motor (Auto-tuning)
------------	----------------------------

The inverter automatically detects the motor parameters and saves them in its internal memory. Basically, it is not necessary to perform tuning when using a Fuji standard motor with a standard connection with the inverter.

In any of the following cases, perform auto-tuning since the motor parameters are different from those of Fuji standard motors so as not to obtain the best performance under each of these controls--auto torque boost, torque calculation monitoring, or auto energy saving operation.

- The motor to be driven is made by other manufacturer or is a non-standard motor.
- Cabling between the motor and the inverter is long.
- A reactor is inserted between the motor and the inverter.



For details of auto tuning, refer to the FRENIC-Eco Instruction Manual (INR-SI47-1059-E), Section 4.1.3 "Preparation before running the motor for a test -- Setting function code data."

P06	Motor (No-load current)
P07	Motor (%R1)
P08	Motor (%X)

These function codes specify no load current, %R1, and %X. Obtain the appropriate values from the test report of the motor or by calling the manufacturer of the motor. If you perform auto tuning, these parameters are automatically set as well.

- No load current: Enter the value obtained from motor manufacturer.
- %R1: Enter the value calculated by the following formula.

$$\%R1 = \frac{R1 + \text{Cable } R1}{V / (\sqrt{3} \times I)} \times 100 (\%)$$

where,

R1: Primary resistance of the motor (Ω)

Cable R1: Resistance of the output cable (Ω)

V: Rated voltage of the motor (V)

I: Rated current of the motor (A)

- %X: Enter the value calculated by the following formula:

$$\%X = \frac{X1 + X2 \times XM / (X2 + XM) + \text{Cable } X}{V / (\sqrt{3} \times I)} \times 100 (\%)$$

where,

X1: Primary leakage reactance of the motor (Ω)

X2: Secondary leakage reactance of the motor (converted to primary) (Ω)

XM: Exciting reactance of the motor (Ω)

Cable X: Reactance of the output cable (Ω)

V: Rated voltage of the motor (V)

I: Rated current of the motor (A)



For reactance, choose the value at the base frequency (F04).

P99**Motor Selection**

P99 specifies the motor to be used.

Data for P99	Motor type
0	Fuji standard motors, 8-series
1	GE motors
3	Fuji standard motors, 6-series
4	Other motors

Automatic control (such as auto-torque boost and auto-energy saving) or electronic thermal motor overload protection uses the motor parameters and characteristics. To match the property of a control system with that of the motor, select characteristics of the motor and set H03 (Data Initialization) to "2" to initialize the old motor parameters stored in the inverter. When initialization is complete, P03, P06, P07, and P08 data and the old related internal data are automatically updated.

For P99, enter the following data according to the motor type.





- P99 = 0: Fuji standard 8-series motors (Current standard)
- P99 = 3: Fuji standard 6-series motors (Conventional standard)
- P99 = 4: Other manufacturer's or unknown motors

- Note**
- If P99 = 4 (Other motors), the inverter runs following the motor characteristics of Fuji standard 8-series.
 - The inverter also supports motors rated by HP (horse power: typical in North America, P99 = 1).

9.2.5 H codes (High performance functions)

H03	Data Initialization
-----	---------------------

H03 initializes the current function code settings to the factory defaults or initializes the motor parameters.

To change the H03 data, it is necessary to press  and  keys or  and  keys simultaneously.

Data for H03	Function
0	Disable initialization (Settings manually made by the user will be retained.)
1	Initialize all function code data to the factory defaults
2	Initialize motor parameters in accordance with P02 (rated capacity) and P99 (motor selection) Function codes subject to initialization: P01, P03, P06, P07, and P08, including the internal control constants (These function codes will be initialized to the values listed in tables on the following pages.)

- To initialize the motor parameters, set the related function codes as follows.
 - 1) P02 Motor (Rated capacity) Set the rated capacity of the motor to be used in kW.
 - 2) P99 Motor Selection Select the characteristics of the motor. (Refer to the descriptions given for P99.)
 - 3) H03 Data Initializing Initialize the motor parameters. (H03=2)
 - 4) P03 Motor (Rated current) Set the rated current on the nameplate if the already set data differs from the rated current printed on the nameplate of the motor.
- Upon completion of the initialization, the H03 data reverts to "0" (factory default).
- If a capacity other than that of applicable motor rating is set at P02, the capacity will be internally converted to the applicable motor rating (see the tables on the following pages).

- When Fuji standard 8-series motors (P99 = 0) or other motors (P99 = 4) are selected, the motor parameters for P02 through P08 are as listed in the following table.

400 V series motors shipped for EU (E)

Motor capacity (kW)	Applicable motor rating (kW)	Rated current (A)	No-load current (A)	%R (%)	%X (%)
P02		P03	P06	P07	P08
0.01 to 0.09	0.06	0.22	0.20	13.79	11.75
0.10 to 0.19	0.10	0.35	0.27	12.96	12.67
0.20 to 0.39	0.20	0.65	0.53	12.95	12.92
0.40 to 0.74	0.4	1.15	0.83	10.20	13.66
0.75 to 1.49	0.75	1.80	1.15	8.67	10.76
1.50 to 2.19	1.5	3.10	1.51	6.55	11.21
2.20 to 3.69	2.2	4.60	2.43	6.48	10.97
3.70 to 5.49	3.7	7.50	3.84	5.79	11.25
5.50 to 7.49	5.5	11.5	5.50	5.28	14.31
7.50 to 10.99	7.5	14.5	6.25	4.50	14.68
11.00 to 14.99	11	21.0	8.85	3.78	15.09
15.00 to 18.49	15	27.5	10.0	3.25	16.37
18.50 to 21.99	18.5	34.0	10.7	2.92	16.58
22.00 to 29.99	22	39.0	12.6	2.70	16.00
30.00 to 36.99	30	54.0	19.5	2.64	14.96
37.00 to 44.99	37	65.0	20.8	2.76	16.41
45.00 to 54.99	45	78.0	23.8	2.53	16.16
55.00 to 74.99	55	95.0	29.3	2.35	16.20
75.00 to 89.99	75	130	41.6	1.98	16.89
90.00 to 109.99	90	155	49.6	1.73	16.03
110.00 to 131.99	110	188	45.6	1.99	20.86
132.00 to 159.99	132	224	57.6	1.75	18.90
160.00 to 199.99	160	272	64.5	1.68	19.73
200.00 to 219.99	200	335	71.5	1.57	20.02
220.00 to 249.99	220	365	71.8	1.60	20.90
250.00 to 279.99	250	415	87.9	1.39	18.88
280.00 to 314.99	280	462	93.7	1.36	19.18
315.00 to 354.99	315	520	120	0.84	16.68
355.00 to 399.99	355	580	132	0.83	16.40
400.00 to 449.99	400	670	200	0.62	15.67
450.00 to 529.99	450	770	270	0.48	13.03
530.00 or above	530	880	270	0.53	13.05

- When Fuji standard 6-series motors (P99 = 3) are selected, the motor parameters for P02 through P08 are as listed in the following table.



The values below in the "Rated current" column are exclusively applicable to the four-pole Fuji standard motors rated for 200 V and 400 V at 50 Hz. Even if you use Fuji standard motors, when those base frequency, rated voltage, and the number of poles differ from the above mentioned, change the P03 data to the rated current shown on the motor's nameplate.

If you use non-standard or other manufacturer's motors, change the P03 data to the rated current printed on the motor's nameplate.

400 V series motors destined for EU (E)

Motor capacity (kW)	Applicable motor rating (kW)	Rated current (A)	No-load current (A)	%R (%)	%X (%)
P02		P03	P06	P07	P08
0.01 to 0.09	0.06	0.22	0.20	13.79	11.75
0.10 to 0.19	0.10	0.35	0.27	12.96	12.67
0.20 to 0.39	0.20	0.65	0.50	12.61	13.63
0.40 to 0.74	0.4	1.20	0.78	10.20	14.91
0.75 to 1.49	0.75	1.80	1.18	8.67	10.66
1.50 to 2.19	1.5	3.10	1.50	6.55	11.26
2.20 to 3.69	2.2	4.60	2.43	6.48	10.97
3.70 to 5.49	3.7	7.50	3.85	5.79	11.22
5.50 to 7.49	5.5	11.0	5.35	5.09	13.66
7.50 to 10.99	7.5	14.5	6.25	4.50	14.70
11.00 to 14.99	11	21.0	8.80	3.78	15.12
15.00 to 18.49	15	27.5	10.0	3.24	16.37
18.50 to 21.99	18.5	34.0	11.0	2.90	17.00
22.00 to 29.99	22	39.0	12.6	2.70	16.05
30.00 to 36.99	30	54.0	19.5	2.69	15.00
37.00 to 44.99	37	65.0	20.8	2.76	16.42
45.00 to 54.99	45	78.0	23.8	2.53	16.16
55.00 to 74.99	55	95.0	29.3	2.35	16.20
75.00 to 89.99	75	130	41.6	1.98	16.89
90.00 to 109.99	90	155	49.6	1.73	16.03
110.00 to 131.99	110	188	45.6	1.99	20.86
132.00 to 159.99	132	224	57.6	1.75	18.90
160.00 to 199.99	160	272	64.5	1.68	19.73
200.00 to 219.99	200	335	71.5	1.57	20.02
220.00 to 249.99	220	365	71.8	1.60	20.90
250.00 to 279.99	250	415	87.9	1.39	18.88
280.00 to 314.99	280	462	93.7	1.36	19.18
315.00 to 354.99	315	520	120	0.84	16.68
355.00 to 399.99	355	580	132	0.83	16.40
400.00 to 449.99	400	670	200	0.62	15.67
450.00 to 529.99	450	770	270	0.48	13.03
530.00 or above	530	880	270	0.53	13.05

- When HP motors (P99 = 1) are selected, the motor parameters for P02 through P08 are as listed in the following table.

Note The values below in the "Rated current" column are exclusively applicable to the four-pole Fuji standard motors rated for 200 V and 400 V at 50 Hz. If you use any of other voltage series, poles other than 4, non-standard or other manufacturer's motors, change the P03 data to its rated current printed on the motor's nameplate.

For 400 V series motors shipped for EU (E)

Motor capacity (HP)	Applicable motor rating (HP)	Rated current (A)	No-load current (A)	%R (%)	%X (%)
P02		P03	P06	P07	P08
0.01 to 0.11	0.1	0.22	0.20	13.79	11.75
0.12 to 0.24	0.12	0.34	0.27	12.96	12.67
0.25 to 0.49	0.25	0.70	0.56	11.02	13.84
0.50 to 0.99	0.5	1.00	0.61	6.15	8.80
1.00 to 1.99	1	1.50	0.77	3.96	8.86
2.00 to 2.99	2	2.90	1.40	4.29	7.74
3.00 to 4.99	3	4.00	1.79	3.15	20.81
5.00 to 7.49	5	6.30	2.39	3.34	23.57
7.50 to 9.99	7.5	9.30	3.12	2.65	28.91
10.00 to 14.99	10	12.70	4.37	2.43	30.78
15.00 to 19.99	15	18.70	6.36	2.07	29.13
20.00 to 24.99	20	24.60	4.60	2.09	29.53
25.00 to 29.99	25	30.00	8.33	1.75	31.49
30.00 to 39.99	30	36.20	9.88	1.90	32.55
40.00 to 49.99	40	45.50	6.80	1.82	25.32
50.00 to 59.99	50	57.50	9.33	1.92	24.87
60.00 to 74.99	60	68.70	10.40	1.29	26.99
75.00 to 99.99	75	86.90	14.30	1.37	27.09
100.00 to 124.99	100	113.00	18.70	1.08	23.80
125.00 to 149.99	125	134.00	14.90	1.05	22.90
150.00 to 174.99	150	169.00	45.20	0.96	21.61
175.00 to 199.99	175	169.00	45.20	0.96	21.61
200.00 to 249.99	200	231.00	81.80	0.72	20.84
250.00 to 299.99	250	272.00	41.10	0.71	18.72
300.00 to 324.99	300	323.00	45.10	0.53	18.44
325.00 to 349.99	325	323.00	45.10	0.53	18.44
350.00 to 399.99	350	375.00	68.30	0.99	19.24
400.00 to 449.99	400	429.00	80.70	1.11	18.92
450.00 to 499.99	450	481.00	85.50	0.95	19.01
500.00 to 599.99	500	534.00	99.20	1.05	18.39
600.00 to 649.99	600	638.00	140.00	0.85	18.38
650.00 or above	650	638.00	140.00	0.85	18.38

H04	Auto-resetting (Times)
H05	Auto-resetting (Reset interval)

While the auto-resetting feature is specified, even if the protective function subject to retry is activated and the inverter enters the forced-to-stop state (tripped state), the inverter will automatically attempt to reset the tripped state and restart without issuing an alarm (for any faults). If the protective function works in excess of the times specified by H04, the inverter will issue an alarm (for any faults) and not attempt to auto-reset the tripped state.

Listed below are the recoverable alarm statuses to be retried.

Alarm status	LED monitor displays:	Alarm status	LED monitor displays:
Instantaneous overcurrent protection	<i>OC 1, OC2 or OC3</i>	Motor overheated	<i>OH4</i>
Overvoltage protection	<i>OU 1, OU2 or OU3</i>	Motor overloaded	<i>OL 1</i>
Heat sink overheated	<i>OH 1</i>	Inverter overloaded	<i>OLU</i>
Inverter overheated	<i>OH3</i>		

■ Number of resetting times (H04)

H04 specifies the number of auto-resetting "retry" times for automatically escaping the tripped state. If the protective function is activated more than the specified resetting (retry) times, the inverter issues an alarm (for any faults) and does not attempt to escape the tripped state.

- Data setting range: 1 to 10 (times) (If "0" is set, the "retry" operation will not be activated.)

WARNING

If the "retry" function has been specified, the inverter may automatically restart and run the motor stopped due to a trip fault, depending on the cause of the tripping.

Design the machinery so that human body and peripheral equipment safety is ensured even when the auto-resetting succeeds.

Otherwise an accident could occur.

■ Reset interval (H05)

- Data setting range: 0.5 to 20.0 (sec.)

H05 specifies the interval time to attempt performing auto-resetting the tripped state. Refer to the timing scheme diagram below.

<Operation timing scheme>

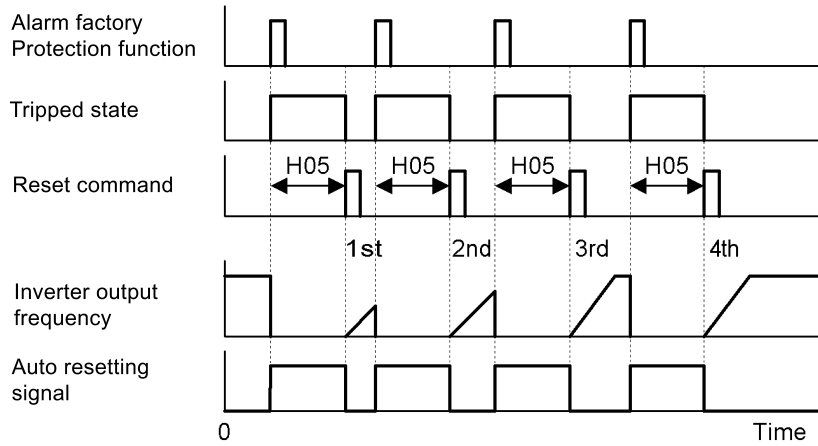

<Timing scheme for failed retry (No. of retry times: 3)>

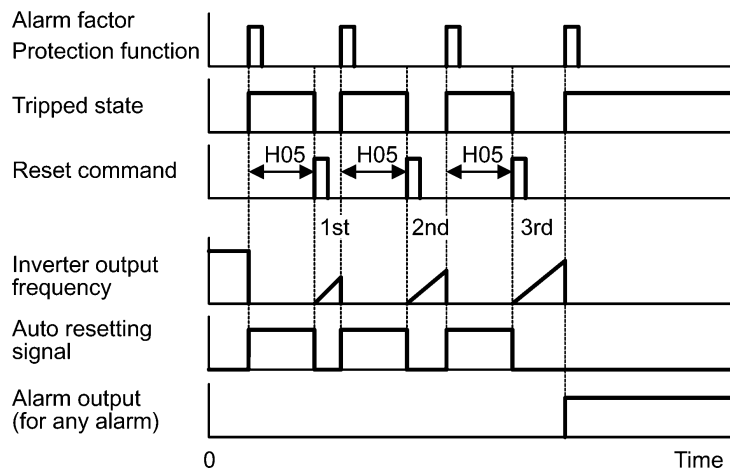

- The retry operation state can be monitored by external equipment via the inverter's output terminal [Y1] through [Y3], [Y5A/C], or [30A/B/C]. Set the data "26" of terminal function (TRY) in function codes E20 through E22, E24 and E27 to one of these terminals.

H06

Cooling Fan ON/OFF Control

To prolong the life of the cooling fan and reduce fan noise during running, the cooling fan stops when the temperature inside the inverter drops below a certain level while the inverter is stopped. However, since frequent switching of the cooling fan shortens its life, the cooling fan is kept running for 10 minutes once it is started.

H06 specifies whether to keep running the cooling fan all the time or to control its ON/OFF.

Data for H06	Cooling fan ON/OFF
0	Disable (Always in operation)
1	Enable (ON/OFF controllable)

H07	Acceleration/Deceleration Pattern
------------	--

H07 specifies the acceleration and deceleration patterns (Patterns to control output frequency).

Data for H07	Accl./Decel. pattern
0	Linear (Default)
1	S-curve (Weak)
2	S-curve (Strong)
3	Curvilinear

Linear acceleration/deceleration

The inverter runs the motor with the constant acceleration and deceleration.

S-curve acceleration/deceleration

To reduce the impact on the inverter-driven motor and/or its mechanical load during acceleration/deceleration, the inverter gradually accelerates/decelerates the motor in both the acceleration/deceleration starting and ending zones. Two types of S-curve acceleration/deceleration are available; 5% (weak) and 10% (strong) of the maximum frequency, which are shared by the four inflection points.

The acceleration/deceleration time command determines the duration of acceleration/deceleration in the linear period; hence, the actual acceleration/deceleration time is longer than the reference acceleration/deceleration time.

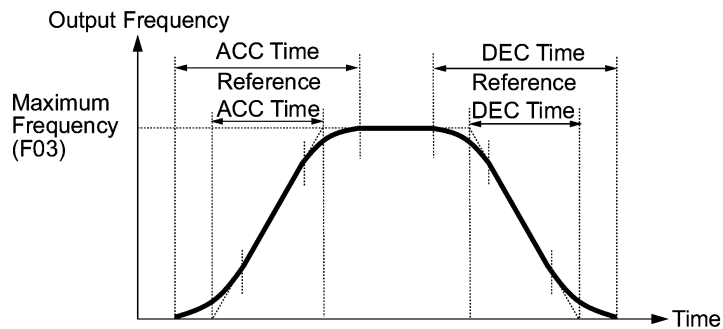

Acceleration/deceleration time

<S-curve acceleration/deceleration (weak): when the frequency change is 10% or more of the maximum frequency>

$$\begin{aligned} \text{Acceleration or deceleration time (s): } & (2 \times 5/100 + 90/100 + 2 \times 5/100) \times (\text{reference acceleration or deceleration time}) \\ & = 1.1 \times (\text{reference acceleration or deceleration time}) \end{aligned}$$

<S-curve acceleration/deceleration (strong): when the frequency change is 20% or more of the maximum frequency>

$$\begin{aligned} \text{Acceleration or deceleration time (s): } & (2 \times 10/100 + 80/100 + 2 \times 10/100) \times (\text{reference acceleration or deceleration time}) \\ & = 1.2 \times (\text{reference acceleration or deceleration time}) \end{aligned}$$

Curvilinear acceleration/deceleration

Acceleration/deceleration is linear below the base frequency (constant torque) but slows down above the base frequency to maintain a certain level of load factor (constant output).

This acceleration/deceleration pattern allows the motor to accelerate or decelerate with the maximum performance of the motor.

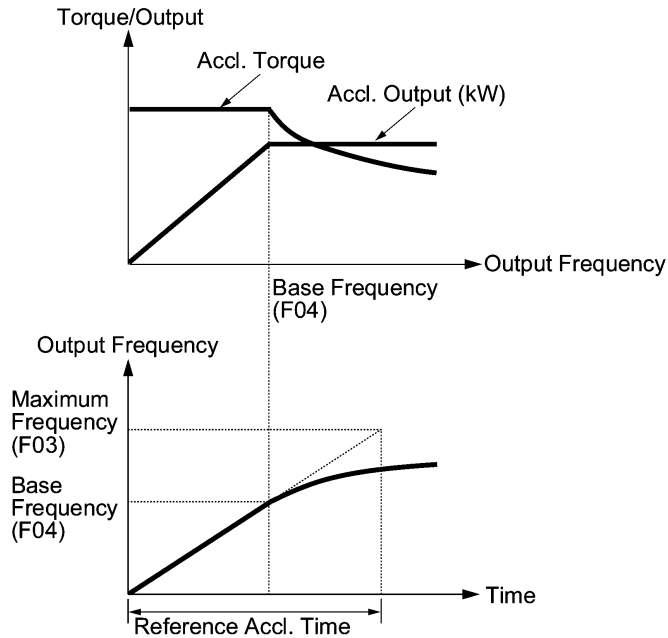

The figures at left show the acceleration characteristics. Similar characteristics apply to the deceleration.

Note Choose an appropriate acceleration/deceleration time considering the machinery's load torque.
For details, refer to Chapter 7 "SELECTING OPTIMAL MOTOR AND INVERTER CAPACITIES."

H09	Select Starting Characteristics (Auto search for idling motor's speed) Refer to H17 and H49.
------------	--

H09 and H17 specify the auto search mode for idling motor's speed and its frequency, respectively, to run the idling motor without stopping it.

The auto search mode can be switched by assigning the (STM) terminal command to one of digital input terminals (E01 to E05, data = 26). If no (STM) is assigned, the inverter interprets it as (STM) being ON by default.

Searching for idling motor's speed

When a run command is turned ON with the (STM) being ON, the inverter starts the auto search operation at the auto search frequency specified by H17 to run the idling motor without stopping it. If there is a large difference between the motor speed and the auto search frequency, the current limiting control may be triggered. The inverter automatically reduces its output frequency to harmonize the idling motor's speed. Upon completion of the harmonization, the inverter releases the current limiting control and accelerates the motor up to the reference frequency according to the preset acceleration time.

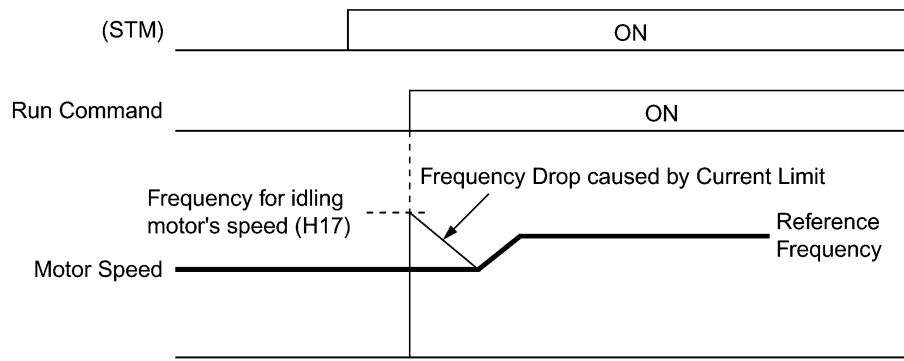

Searching for idling motor's speed to follow

Note The frequency drop caused by the current limiting control during auto search for idling motor's speed is determined by the frequency fall rate specified by H14.

To use the auto search, be sure to enable the instantaneous overcurrent limiting (H12 = 1).

■ Select starting characteristic (STM) (Digital input signal)

The (STM) terminal command specifies whether or not to perform auto search operation for idling motor's speed at the start of running.

Data for H09	"Select starting characteristics" terminal command (STM)	Function
0: Disable	--	Start at the starting frequency
3, 4, 5: Enable	ON	Start at the auto search frequency specified by H17
	OFF	Start at the starting frequency

■ Frequency for idling motor's speed (H17)

H17 specifies the auto search frequency for idling motor's speed. Be sure to set a value higher than the idling motor's speed. Otherwise, an overvoltage trip may occur. If the current motor speed is unknown, specify "999" that uses the maximum frequency at the start of auto search operation.

■ Auto search for idling motor's speed (H09)

H09 specifies the starting rotational direction (forward/reverse) of the auto search and the starting pattern (patterns 1 to 4). If the motor is idling in the reverse direction that is against the specified direction because of natural convection, it is necessary to start it in the direction opposite to the rotational direction of the original reference frequency.

When the rotational direction of the idling motor is unknown, two starting patterns are provided as listed below, which start search from the forward rotation and, if not succeeded from the reverse rotation (e.g. H09 =5, pattern 3), start search from the reverse rotation (e.g. H09 =5, pattern 4).

Data for H09	Run command	Rotational direction at the start of auto search	Starting pattern
3	Run forward	Forward	Pattern 1
	Run reverse	Reverse	Pattern 2
4	Run forward	Forward	Pattern 3
	Run reverse	Reverse	Pattern 4
5	Run forward	Reverse	Pattern 4
	Run reverse	Forward	Pattern 3

Starting patterns

The inverter makes its frequency shift in accordance with the starting patterns shown below to search the speed and rotation direction of the idling motor. When harmonization is complete between the motor speed (including its rotation direction) and the inverter output frequency, the frequency shift by auto search operation is terminated.

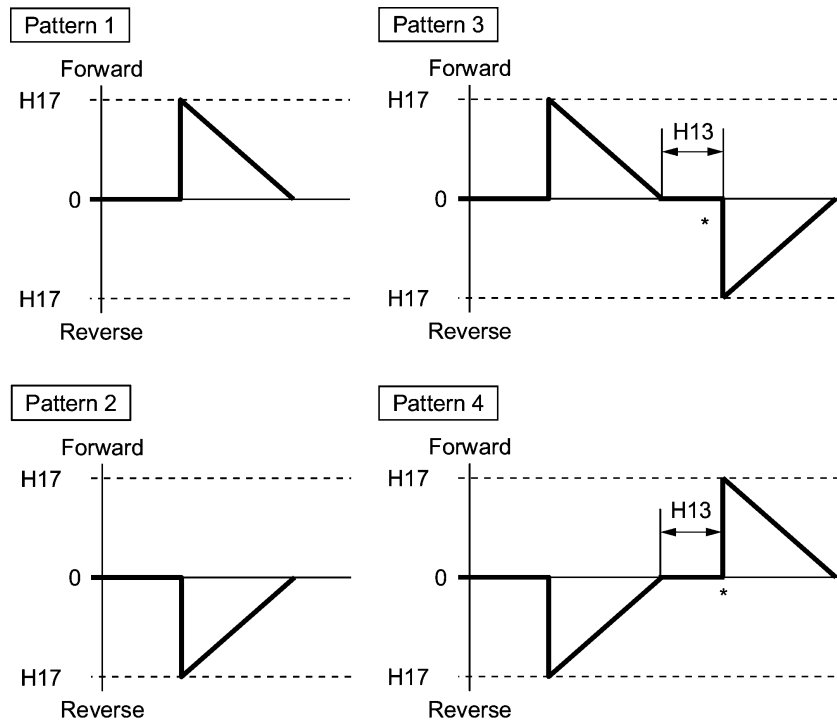

* Only when the auto search has not succeeded at the first trial, the starting from the opposite direction is attempted.

Starting Patterns



Auto search operation is attempted using one of the patterns shown above. If not succeeded, it will be tried again. If seven consecutive retries fail, the inverter will issue alarm and stop.

H11**Deceleration Mode**

H11 specifies the mode of deceleration when a run command is turned OFF.

Data for H11	Function
0	Normal deceleration The inverter decelerates and stops the motor according to deceleration commands specified by H07 (Acceleration/deceleration pattern) and F08 (Deceleration time 1).
1	Coast-to-stop The inverter immediately shuts down its output. The motor stops according to the inertia of motor and load machinery and their kinetic energy losses.



When the reference frequency is low, the inverter decelerates the motor according to the deceleration commands even if H11 = 1 (Coast-to-stop).

H12**Instantaneous Overcurrent Limiting**

H12 specifies whether the inverter invokes the current limit processing or enters the overcurrent trip when its output current exceeds the instantaneous overcurrent limiting level. Under the current limit processing, the inverter immediately turns off its output gate to suppress the further current increase and continues to control the output frequency.

Data for H12	Function
0	Disable An overcurrent trip occurs at the instantaneous overcurrent limiting level.
1	Enable The current limiting operation is effective.

If any problem occurs when the motor torque temporarily drops during current limiting processing, it is necessary to cause an overcurrent trip (H12 = 0) and actuate a mechanical brake at the same time.



Function codes F43 and F44 have current limit functions similar to that of function code H12. Since the current limit functions of F43 and F44 implement the current control by software, an operation delay occurs. When you have enabled the current limit by F43 and F44, enable the current limit operation by H12 as well, to obtain a quick response current limiting.

Depending on the load, extremely short acceleration time may activate the current limiting to suppress the increase of the inverter output frequency, causing the system oscillation (hunting) or activating the inverter overvoltage trip (alarm $\overline{U}1$). When setting the acceleration time, therefore, you need to take into account machinery characteristics and moment of inertia of the load.

H13	Restart after Momentary Power Failure (Restart time) (Refer to F14.)
H14	Restart after Momentary Power Failure (Frequency fall rate) (Refer to F14.)
H15	Restart after Momentary Power Failure (Continuous running level) (Refer to F14.)
H16	Restart after Momentary Power Failure (Allowable momentary power failure time) (Refer to F14.)

For how to set these function codes (Restart time, Frequency fall rate, Continuous running level and Allowable momentary power failure time), refer to the description of function code F14.

H17	Select Starting Characteristics (Frequency for idling motor's speed) (Refer to F09.)
------------	--

For how to set the starting frequency for the auto search for idling motor's speed, refer to the description of function code H09.

H26	PTC Thermistor (Mode selection)
H27	PTC Thermistor (Level)

These function codes specify the PTC (Positive Temperature Coefficient) thermistor embedded in the motor. The thermistor is used to protect the motor from overheating or output an alarm signal.

■ PTC thermistor (Mode selection) (H26)

Selects the function operation mode (protection or alarm) for the PTC thermistor as shown below.

Data for H26	Action
0	Disable
1	Enable When the voltage sensed by the PTC thermistor exceeds the detection level, the motor protective function (alarm \overline{AL}) is triggered, causing the inverter to enter an alarm stop state.
2	Enable When the voltage sensed by the PTC thermistor exceeds the detection level, a motor alarm signal is output but the inverter continues running. You need to assign the motor overheat protection (THM) to one of the digital output terminals beforehand, by which a temperature alarm condition can be detected by the thermistor (PTC) (function code data = 56).

■ PTC thermistor (Level) (H27)

Specifies the detection level for the temperature (expressed in voltage) sensed by PTC thermistor.

- Data setting range: 0.00 to 5.00 (V)

The temperature at which the overheating protection is to be activated depends on the characteristics of the PTC thermistor. The internal resistance of the thermistor will significantly change at the alarm temperature. The detection level (voltage) is specified based on the change of internal resistance.

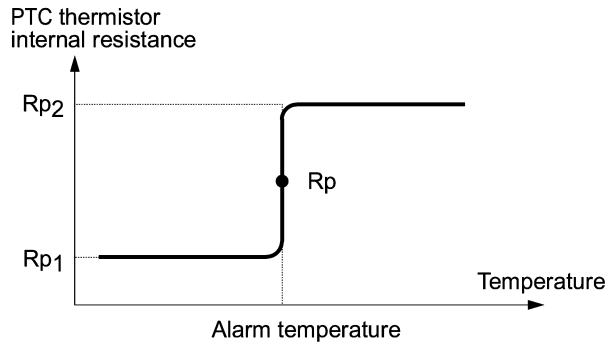

Suppose that the internal resistance of the PTC thermistor at the alarm temperature is R_p , the detection level (voltage) V_{v2} is calculated by the expression below. Set the result V_{v2} to function code H27.

$$V_{v2} = \frac{\frac{237 \times R_p}{237 + R_p}}{1000 + \frac{237 \times R_p}{237 + R_p}} \times 10 \text{ (V)}$$

Connect the PTC thermistor as shown below. The voltage that is obtained by dividing the input voltage to terminal [V2] with a set of internal resistors is compared with the preset detection level voltage (H27).

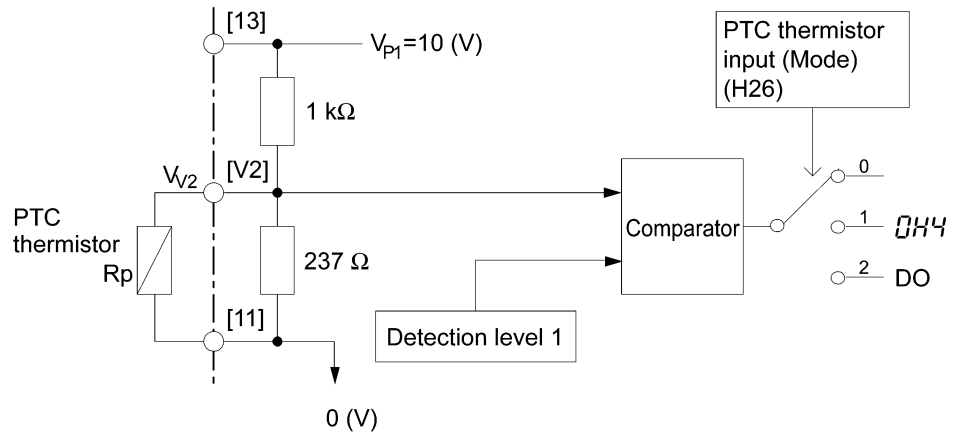

H30 and y98 specify the sources of a frequency command and run command--"inverter itself" and "computers or PLCs via the RS-485 communications link (standard or option) or field bus (option)." H30 is for the RS-485 communications link; y98 for the field bus.

Using the communications link function allows you to monitor the operation information of the inverter and the function code data, set frequency commands, and issue run commands from a remote location.

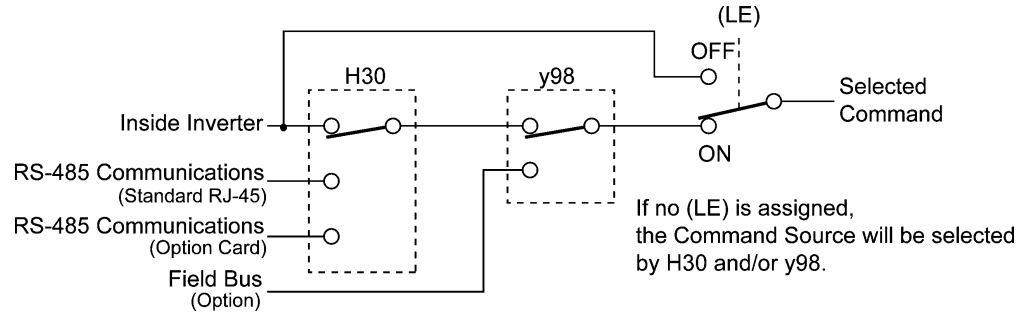

Command sources selectable

Command sources	Description
Inverter itself	Sources except RS-485 communications link and field bus Frequency command source: Specified by F01 and C30, or multistep frequency command Run command source: Via the keypad or digital input terminals
Via RS-485 communications link (standard)	Via the standard RJ-45 port used for connecting keypad
Via RS-485 communications link (option card)	Via RS-485 communications link (option card)
Via field bus (option)	Via field bus (option) using FA protocol such as DeviceNet or PROFIBUS-DP

Command sources specified by H30

Data for H30	Frequency command	Run command
0	Inverter itself (F01/C30)	Inverter itself (F02)
1	Via RS-485 communications link (standard)	Inverter itself (F02)
2	Inverter itself (F01/C30)	Via RS-485 communications link (standard)
3	Via RS-485 communications link (standard)	Via RS-485 communications link (standard)
4	Via RS-485 communications link (option card)	Inverter itself (F02)
5	Via RS-485 communications link (option card)	Via RS-485 communications link (standard)
6	Inverter itself (F01/C30)	Via RS-485 communications link (option card)
7	Via RS-485 communications link (standard)	Via RS-485 communications link (option card)
8	Via RS-485 communications link (option card)	Via RS-485 communications link (option card)

Command sources specified by y98

Data for y98	Frequency command	Run command
0	Follow H30 data	Follow H30 data
1	Via field bus (option)	Follow H30 data
2	Follow H30 data	Via field bus (option)
3	Via field bus (option)	Via field bus (option)

Combination of command sources

		Frequency command source			
		Inverter itself	Via RS-485 communications link (standard)	Via RS-485 communications link (option card)	Via field bus (option)
Run command source	Inverter itself	H30 = 0 y98 = 0	H30 = 1 y98 = 0	H30=4 y98=0	H30=0 (1 or 4) y98=1
	Via RS-485 communications link (standard)	H30 = 2 y98 = 0	H30 = 3 y98 = 0	H30=5 y98=0	H30=2 (3 or 5) y98=1
	Via RS-485 communications link (option card)	H30 = 6 y98 = 0	H30 = 7 y98 = 0	H30=8 y98=0	H30=6 (7 or 8) y98=1
	Via field bus (option)	H30 = 0 (2 or 6) y98 = 2	H30 = 1 (3 or 7) y98 = 2	H30 = 4 (5 or 8) y98 = 2	H30 = 0 (1 to 8) y98 = 3



For details, refer to Chapter 4 "BLOCK DIAGRAMS FOR CONTROL LOGIC" and the RS-485 Communication User's Manual (MEH448) or the Field Bus Option Instruction Manual.

- When the (LE) terminal command is assigned to a digital input terminal and the terminal is ON, the settings of function code H30 and y98 are effective. When the terminal is OFF, the settings of those function codes are ineffective, and both frequency commands and run commands specified from the inverter itself take control.

H42

Capacitance of DC Link Bus Capacitor

H42 displays the measured capacitance of the DC link bus capacitor (reservoir capacitor).

H43

Cumulative Run Time of Cooling Fan

H43 displays the cumulative run time of the cooling fan.

H47

Initial Capacitance of DC Link Bus Capacitor

H47 displays the initial value of the capacitance of the DC link bus capacitor (reservoir capacitor).

H48

Cumulative Run Time of Capacitors on the Printed Circuit Board

H48 displays the cumulative run time of the capacitors mounted on the printed circuit board.

H49	Select Starting Characteristics (Auto search time for idling motor's speed)
------------	--

H49 specifies the harmonizing time.
 - Data setting range: 0.0 to 10.0 (sec.)

H50	Non-linear V/f Pattern (Frequency)	Refer to F04.
------------	---	----------------------

H51	Non-linear V/f Pattern (Voltage)	Refer to F05.
------------	---	----------------------

For details of setting the non-linear V/f pattern, refer to the descriptions of function codes F04 and F05.

H56	Deceleration Time for Forced Stop
------------	--

When (STOP) is turned on while the forced to stop signal (STOP) is assigned to the digital input terminal (function code data = 30), the inverter output decelerates to stop in accordance with the setting of H56 (Deceleration time for forced to stop). When the inverter output has stopped after deceleration, it enters an alarm stop state, with the alarm $\bar{E}r\bar{E}$ displayed.

H63	Low Limiter (Mode selection)	Refer to F15 and F16.
------------	-------------------------------------	------------------------------

For how to set up this function code data, refer to the description of function codes F15 and F16.

H64	Low Limiter (Lower limiting frequency)
------------	---

When the output current limiter and/or overload prevention control is activated, this function specifies the lower limit of the frequency that may vary with the limit control.
 - Data setting range: 0.0 to 60.0 (Hz)

H69	Automatic Deceleration
------------	-------------------------------

H69 specifies whether automatic deceleration control is to be enabled or disabled. During deceleration of the motor, if regenerative energy exceeds the level that can be handled by the inverter, overvoltage trip may happen. With automatic deceleration enabled, when the DC link bus voltage exceeds the level (internally fixed) for starting automatic deceleration, the output frequency is controlled to prevent the DC link bus voltage from rising further; thus regenerative energy is suppressed.

Data for H69	Function
0	Disable
3	Enable

Note If automatic deceleration is enabled, deceleration may take a longer time. This is designed to limit the torque during deceleration, and is therefore of no use where there is a braking load.

Disable the automatic deceleration when a braking unit is connected. The automatic deceleration control may be activated at the same time when a braking unit starts operation, which may make the acceleration time fluctuate. In case the set deceleration time is so short, the DC link bus voltage of the inverter rises quickly, and consequently, the automatic deceleration may not follow the voltage rise. In such a case, prolong the deceleration time.

Even if the time period of 3 times of the deceleration time 1 (F08) has elapsed after the inverter entered automatic deceleration, there may be a case that the motor does not stop or the frequency does not decrease. In this case, cancel the automatic deceleration forcibly for safety and decelerate the motor according to the set deceleration time. Prolong the deceleration time also.

H70**Overload Prevention Control**

H70 specifies the decelerating rate of the output frequency to prevent a trip from occurring due to an overload. This control decreases the output frequency of the inverter before the inverter trips due to a heat sink overheat or inverter overload (with an alarm indication of \overline{OH} /or \overline{OL} , respectively). It is useful for equipment such as pumps where a decrease in the output frequency leads to a decrease in the load and it is necessary to keep the motor running even when the output frequency drops.

Data for H70	Function
0.00	Decelerate the motor by deceleration time 1 specified by F08
0.01 to 100.0	Decelerate the motor by deceleration rate 0.01 to 100.0 (Hz/s)
999	Disable overload prevention control



In applications where a decrease in the output frequency does not lead to a decrease in the load, this function is of no use and should not be enabled.

H71**Deceleration Characteristics**

Setting this function code to "1" (ON) enables forced brake control. If the regenerative energy produced during the deceleration of the motor exceeds the inverter's regenerative braking capacity, an overvoltage trip will occur. Forced brake control increases the loss of the motor and the deceleration torque during deceleration.

Data for H71	Function
0	Disable
1	Enable



This function is aimed at controlling the torque during deceleration; it has no effect if there is braking load.

H80**Gain for Suppression of Output Current Fluctuation for Motor**

The inverter output current driving the motor may fluctuate due to the motor characteristics and/or backlash in the mechanical load. Modify the data in function code H80 to adjust the controls in order to suppress such fluctuation. However, as incorrect setting of this gain may cause larger current fluctuation, do not modify the default setting unless it is necessary.

- Data setting range: 0.00 to 0.40

H91**Terminal [C1] Wire Break Detection**

H91 specifies whether or not to enable the wire break detection on the terminal [C1], or the detection time. If all of the following conditions are met when the H91 data is within the specified range, the inverter issues alarm (\overline{CB}).

- Input current to terminal [C1]: Below 2 mA (after filtering with C38)
- Terminal [C1] being used as a PID feedback amount input terminal (E62 = 5)
- Under PID control

- Data setting range: 0.0 (Disable alarm detection)
0.1 to 60.0 s (Detect wire break and issue \overline{CB} alarm)

H92	Continue to Run (P-component: gain)	Refer to F14.
H93	Continue to Run (I-component: time)	Refer to F15.

For how to set continuous running (P, I), refer to the description of function code F14.

H94	Cumulative Run Time of Motor
------------	-------------------------------------

You can view the cumulative run time of the motor on the keypad. This feature is useful for management and maintenance of the mechanical system. With this function code (H94), you can set the cumulative run time of the motor to any value you choose. For example, by specifying "0," you can clear the cumulative run time of the motor.

 **Note** The data for H94 is in hexadecimal notation. Check the cumulative run time of the motor on the keypad.

H95	DC Braking (Braking response mode)	(Refer to F20 through F22.)
------------	---	------------------------------------



For how to set DC braking, refer to the description of function codes F20 through F22.

H96	STOP Key Priority/Start Check Function
------------	---

The inverter can be operated using a functional combination of "Priority on  Key" and "Start Check."

Data for H96	STOP key priority	Start check function
0	Disable	Disable
1	Enable	Disable
2	Disable	Enable
3	Enable	Enable

■ **STOP key priority**

Even when the run commands are received from the digital input terminals or via the RS-485 communications link (link operation), pressing the  key forces the inverter to decelerate and stop the motor. " " is displayed on the LED monitor after stopping.



■ **Start check function**

For safety, this function checks whether any run command has been turned ON or not. If a run command has been turned ON, an alarm code " " is displayed on the LED monitor without the inverter being started up. This applies to the following situations:

- When any run command has been ON when the power to the inverter is turned ON.
- A run command is already input when the  key is pressed to release the alarm status or when the "Reset alarm" command (RST) (digital input) is input.
- When the run command source has been switched by the "Enable communications link" command (LE) (digital input) or "Switch run command 2/1" command (FR2/FR1), a run command is already turned ON at the new source.

H97	Clear Alarm Data
------------	-------------------------

H97 deletes the information such as alarm history and data at the time of alarm occurrence, including alarms that have occurred during the check-up or adjustment of the machinery. Data is then brought back to a normal state without an alarm.

Deleting the alarm information requires simultaneous keying of  and  keys.



Data for H97	Function
0	Disable
1	Clear all (This data clears all alarm data stored and returns to "0.")

H98	Protection/Maintenance Function	Refer to F26.
------------	--	----------------------

H98 specifies whether to enable or disable (a) automatic lowering of carrier frequency, (b) input phase loss protection, (c) output phase loss protection, and (d) judgment on the life of the DC link bus capacitor, as well as specifying the judgment threshold on the life of the DC link bus capacitor and the selection of handling on DC fan lock detection, in a style of combination (Bit 0 to Bit 5).

Automatic lowering of carrier frequency (Bit 0)

This function should be used for important machinery that requires keeping the inverter running.

Even if a heat sink overheat or overload occurs due to excessive load, abnormal ambient temperature, or cooling system failure, enabling this function lowers the carrier frequency to avoid tripping ( /  or ). Note that enabling this function results in increased motor noise.

Input phase loss protection () (Bit 1)

Upon detection of an excessive stress inflicted on the apparatus connected to the main circuit due to phase loss or line-to-line voltage unbalance in the three-phase power supplied to the inverter, this feature stops the inverter and displays an alarm .

 In configurations where only a light load is driven or a DC reactor is connected, phase loss or line-to-line voltage unbalance may not be detected because of the relatively small stress on the apparatus connected to the main circuit.

Output phase loss protection () (Bit 2)

Upon detection of phase loss in the output while the inverter is running, this feature stops the inverter and displays an alarm . Where a magnetic contactor is installed in the inverter output circuit, if the magnetic contactor goes OFF during operation, all the phases will be lost. In such a case, this protection feature does not work.

Judgment threshold on the life of DC link bus capacitor (Bit 3)

Bit 3 is used to select the threshold for judging the life of the DC link bus capacitor between factory default setting and your own choice.

 Before specifying the threshold of your own choice, measure and confirm the reference level in advance. For details, refer to the FRENIC-Eco Instruction Manual (INR-S147-1059-E), Chapter 7 "MAINTENANCE AND INSPECTION."

Judgment on the life of DC link bus capacitor (Bit 4)

Whether the DC link bus capacitor has reached its life is determined by measuring the length of time for discharging after power off. The discharging time is determined by the capacitance of the DC link bus capacitor and the load inside the inverter. Therefore, if the load inside the inverter fluctuates significantly, the discharging time cannot be accurately measured, and as a result, it may be mistakenly determined that the life has been reached. To avoid such an error, you can disable the judgment on the life of the DC link bus capacitor.

Since load may vary significantly in the following cases, disable the judgment on the life during operation. Either conduct the measurement with the judgment enabled under appropriate conditions during periodical maintenance or conduct the measurement under the operating conditions matching the actual ones.

- Auxiliary input for control power is used
- An option card or multi-function keypad is used
- Another inverter or equipment such as a PWM converter is connected to the terminals of the DC link bus.



For details, refer to the FRENIC-Eco Instruction Manual (INR-SI47-1059-E), Chapter 7 "MAINTENANCE AND INSPECTION."

DC fan lock detection (Bit 5)

(200 V class series: 45 kW or above, 400 V class series: 55 kW or above)

An inverter of 45 kW or above (200 V class series), or of 55 kW or above (400 V class series) is equipped with the internal air circulation DC fan. When the inverter detects that the DC fan is locked by a failure or other cause, you can select either continuing the inverter operation or entering into alarm state.

Entering alarm state: The inverter issues the alarm \overline{AL} and coasts to stop the motor.

Continuing operation: The inverter does not enter the alarm mode, and continues operation of the motor.

Note that, however, the inverter turns on (OH) and (LIFE) signals on the transistor output terminals whenever the DC fan lock is detected regardless your selection.



If ON/OFF control of the cooling fan is enabled (H06 = 1), the cooling fan may stop depending on operating condition of the inverter. In this case, the DC fan lock detection feature is considered normal (e.g.; the cooling fan is normally stopped by the stop fan command.) so that the inverter may turn off the (LIFE) or (OH) signal output, or enable to cancel the alarm \overline{AL} , even if the internal air circulation DC fan is locked due to a failure etc. (When you start the inverter in this state, it automatically issues the run fan command, then the inverter detects the DC fan lock state, and turn on the (LIFE) or (OH) output or enters the alarm \overline{AL} state.)

Note that, operating the inverter under the condition that the DC fan is locked for long time may shorten the life of electrolytic capacitors on the printed circuit board due to local high temperature inside the inverter. Be sure to check with the (LIFE) signal etc., and replace the broken fan as soon as possible.

To set data of the function code H98, assign functions to each bit (total 6 bits) and set it in decimal format. The table below lists functions assigned to each bit.

Bit	Bit 5	Bit 4	Bit 3	Bit 2	Bit 1	Bit 0
Function	Detect DC fan lock	Judge the life of DC link bus capacitor	Select life judgment criteria of DC link bus capacitor	Detect output phase loss	Detect input phase loss	Lower the carrier frequency automatically
Data = 0	Enter into the alarm state	Disable	Use the factory default	Disable	Disable	Disable
Data = 1	Continue the operation	Enable	Use the user setting	Enable	Enable	Enable
Example of decimal expression (19)	Enter into the alarm state (0)	Enable (1)	Use the factory default (0)	Disable (0)	Enable (1)	Enable (1)

Conversion table (Decimal to/from binary)

Decimal	Binary						Decimal	Binary					
	Bit 5	Bit 4	Bit 3	Bit 2	Bit 1	Bit 0		Bit 5	Bit 4	Bit 3	Bit 2	Bit 1	Bit 0
0	0	0	0	0	0	0	32	1	0	0	0	0	0
1	0	0	0	0	0	1	33	1	0	0	0	0	1
2	0	0	0	0	1	0	34	1	0	0	0	1	0
3	0	0	0	0	1	1	35	1	0	0	0	1	1
4	0	0	0	1	0	0	36	1	0	0	1	0	0
5	0	0	0	1	0	1	37	1	0	0	1	0	1
6	0	0	0	1	1	0	38	1	0	0	1	1	0
7	0	0	0	1	1	1	39	1	0	0	1	1	1
8	0	0	1	0	0	0	40	1	0	1	0	0	0
9	0	0	1	0	0	1	41	1	0	1	0	0	1
10	0	0	1	0	1	0	42	1	0	1	0	1	0
11	0	0	1	0	1	1	43	1	0	1	0	1	1
12	0	0	1	1	0	0	44	1	0	1	1	0	0
13	0	0	1	1	0	1	45	1	0	1	1	0	1
14	0	0	1	1	1	0	46	1	0	1	1	1	0
15	0	0	1	1	1	1	47	1	0	1	1	1	1
16	0	1	0	0	0	0	48	1	1	0	0	0	0
17	0	1	0	0	0	1	49	1	1	0	0	0	1
18	0	1	0	0	1	0	50	1	1	0	0	1	0
19	0	1	0	0	1	1	51	1	1	0	0	1	1
20	0	1	0	1	0	0	52	1	1	0	1	0	0
21	0	1	0	1	0	1	53	1	1	0	1	0	1
22	0	1	0	1	1	0	54	1	1	0	1	1	0
23	0	1	0	1	1	1	55	1	1	0	1	1	1
24	0	1	1	0	0	0	56	1	1	1	0	0	0
25	0	1	1	0	0	1	57	1	1	1	0	0	1
26	0	1	1	0	1	0	58	1	1	1	0	1	0
27	0	1	1	0	1	1	59	1	1	1	0	1	1
28	0	1	1	1	0	0	60	1	1	1	1	0	0
29	0	1	1	1	0	1	61	1	1	1	1	0	1
30	0	1	1	1	1	0	62	1	1	1	1	1	0
31	0	1	1	1	1	1	63	1	1	1	1	1	1

9.2.6 J codes (Application functions)

J01	PID Control (Mode selection)
J02	PID Control (Remote process command)
J03	PID Control (Gain)
J04	PID Control (Integral time)
J05	PID Control (Differential time)
J06	PID Control (Feedback filter)

In PID control, the state of control object is detected by a sensor or similar device and is compared with the commanded value (e.g. temperature control command). If there is any deviation between them, the PID control operates so as to minimize it. Namely, it is a closed loop feedback system that matches controlled variable (feedback value). The PID control applies to a process control such as flowrate control, pressure control, and temperature control as shown in the schematic block diagram below.

If PID control is enabled (J01 = 1 or 2), the frequency control of the inverter is switched from the drive frequency command generator block to the PID frequency command generator block.

Refer to Section 4.8 "PID Frequency Command Generator" for details.

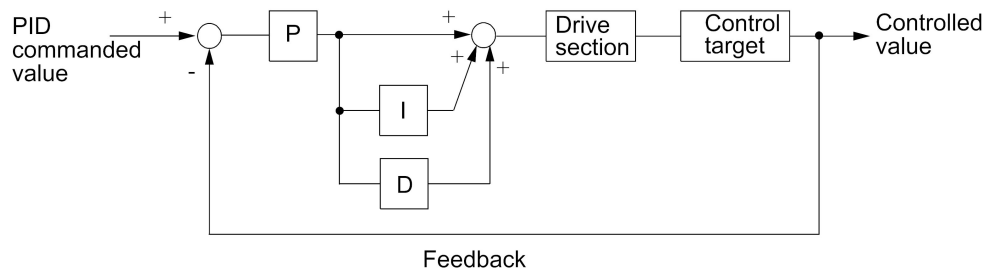

■ Mode Selection (J01)

J01 selects PID control function.

Data for J01	Function
0	Disable PID control
1	Enable PID control (normal operation)
2	Enable PID control (inverse operation)

- As normal operation or inverse operation against the output of PID control can be selected, you can fine-control the motor speed and rotation direction against the difference between commanded value and feedback value. Thus, FRENIC-Eco inverters can apply to many kinds of applications such as air conditioners. The operation mode can also be switched between normal and inverse by using the "Switch normal/inverse operation" terminal command (IVS).

Refer to function codes E01 to E05 for details of assignment of the (IVS) command.

Selection of feedback terminals

For feedback control, determine the connection terminal according to the type of the sensor output.

- If the sensor is current output type, use the current input terminal [C1] of the inverter.
- If the sensor is voltage output type, use the voltage input terminal [12] or [V2] of the inverter.



For details, refer to the description of function codes E61 through E63.

The operating range for PID control is internally controlled as 0% through 100%. For the given feedback input, determine the range of control by means of gain adjustment.

For example, if the sensor output is in the range of 1 to 5 V:

- Use terminal [12] since this is a voltage input.
- Example of gain adjustment
Set Gain adjustment (C32) at 200%, so that the maximum value (5 V) of the external sensor's output corresponds to 100%. Note that the input specification for terminal [12] is 0 - 10 V corresponding to 0 - 100%; thus, a gain factor of 200% ($= 10 \text{ V} \div 5 \times 100$) should be specified. Note also that any bias setting must not apply to feedback control.

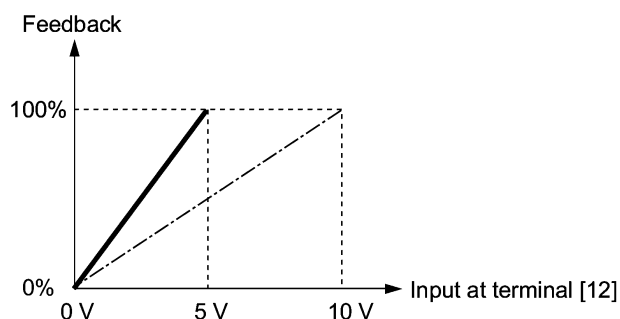

■ Remote process command (J02)

J02 specifies the source to set the command value (SV) under PID control.

Data for J02	Function
0	Keypad Using the \odot / \ominus key on the keypad in conjunction with display coefficients E40 and E41, you can specify the PID process command in 0 to 100% of the easy-to-understand converted command format, such as in temperature and pressure. For details of operation, refer to Chapter 3 "OPERATION USING THE KEYPAD."
1	PID process command 1 (Terminals [12], [C1], [V2]) In addition to J02, various analog settings (function codes E61, E62, and E63) also need to select PID process command 1. For details, refer to function codes E61, E62, and E63.
3	UP/DOWN command Using the UP (UP) or DOWN (DOWN) command in conjunction with display coefficients E40 and E41, you can specify the PID process command in 0 to 100% of the easy-to-understand converted command format. In addition to setting J02 at "3," you also need to assign the function selection for the E01 through E05 terminals ([X1] to [X5]) to the UP (UP) and DOWN (DOWN) commands (function code data = 17, 18). For details of (UP)/(DOWN) operation, refer to the assignment of the UP (UP) and DOWN (DOWN) command.
4	Command via communications link Use the function code (S13) for communications-linked PID process command: the transmission data of 20000 (decimal) is equal to 100% (max. frequency) of the process command. For details of the communications format etc., refer to the RS-485 Communication User's Manual (MEH448).

Note Other than the process command selection by function code J02, the multistep frequency (C08 = 4) specified by the terminal command (SS4) can also be selected as a preset value for the PID process command.

Calculate the setting data of the process command using the equation below.

$$\text{Process command data (\%)} = (\text{Preset multistep frequency}) \div (\text{Maximum frequency}) \times 100$$

Setting range for PID process command (for analog input only)

The operating range for PID control is internally controlled at 0% through 100%. Therefore, if you use an analog input as a PID process command, you need to set the range of the PID process command beforehand. As with frequency setting, you can arbitrary map relationship between the process command and the analog input value by adjusting the gain and bias.

 For details, refer to the description of function codes C32, C34, C37, C39, C42, C44, C51, and C52.

Example) Mapping the range of 1 through 5 V at the terminal [12] to 0 through 100%

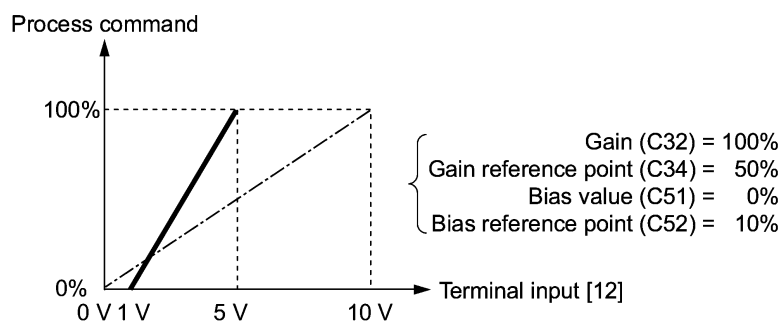

PID display coefficient and monitoring

To monitor the PID process command and its feedback value, set the display coefficient to convert the displayed value into easy-to-understand numerals of the process control value such as temperature.

 Refer to function codes E40 and E41 for details on display coefficients, and to E43 for details on monitoring.

■ Gain (J03)

J03 specifies the gain for the PID processor.

- Data setting range: 0.000 to 30.000 (multiple)

P (Proportional) action

An operation that an MV (manipulated value: output frequency) is proportional to the deviation is called P action, which outputs a manipulated value in proportion to deviation. However, the manipulated variable alone cannot eliminate deviation.

Gain is data that determines the system response level against the deviation in the P action. An increase in gain speeds up response, an excessive gain may cause vibration, and a decrease in gain delays response.

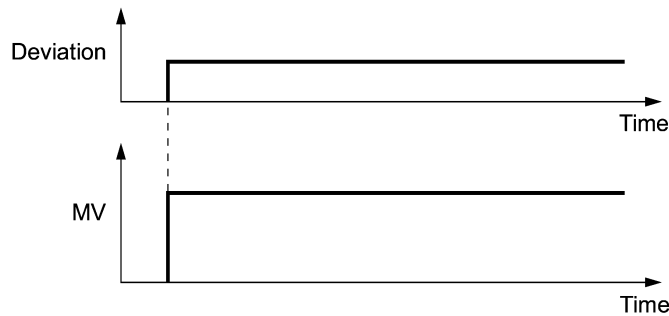

■ Integral time (J04)

J04 specifies the integral time for the PID processor.

- Data setting range: 0.0 to 3600.0 (sec.)

0.0 means that the integral component is ineffective.

I (Integral) action

An operation that the change rate of an MV (manipulated value: output frequency) is proportional to the integral value of deviation is called I action that outputs the manipulated value that integrates the deviation. Therefore, I action is effective in bringing the feedback value close to the commanded value. For the system whose deviation rapidly changes, however, this action cannot make it react quickly.

The effectiveness of I action is expressed by integral time as parameter, that is J4 data. The longer the integral time, the slower the response. The reaction to the external turbulence also becomes slow. The shorter the integral time, the faster the response. Setting too short integral time, however, makes the inverter output tend to oscillate against the external turbulence.

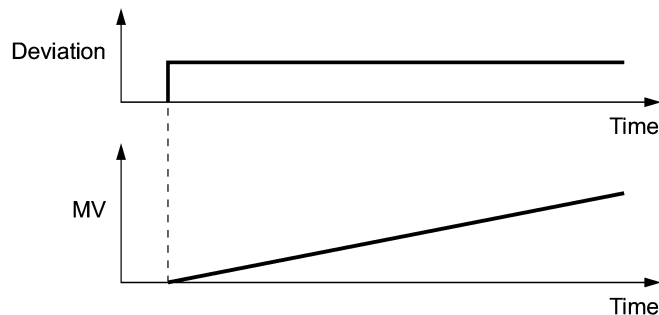

■ Differential time (J05)

J05 specifies the differential time for the PID processor.

- Data setting range: 0.00 to 600.00 (sec.)

0.0 means that the differential component is ineffective.

D (Differential) action

An operation that the MV (manipulated value: output frequency) is proportional to the differential value of the deviation is called D action that outputs the manipulated value that differentiates the deviation. D action makes the inverter quickly react to a rapid change of deviation.

The effectiveness of D action is expressed by differential time as parameter, that is J05 data. Setting a long differential time will quickly suppress oscillation caused by P action when a deviation occurs. Too long differential time makes the inverter output oscillation more. Setting short differential time will weaken the suppression effect when the deviation occurs.

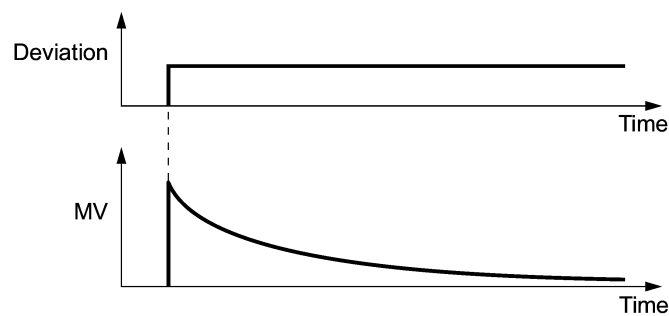

The combined use of P, I, and D actions are described below.

(1) PI control

PI control, which is a combination of P and I actions, is generally used to minimize the remaining deviation caused by P action. PI control acts to always minimize the deviation even if a commanded value changes or external disturbance steadily occurs. However, the longer the integral time, the slower the system response to quick-changed control.

P action can be used alone for loads with very large part of integral components.

(2) PD control

In PD control, the moment that a deviation occurs, the control rapidly generates much manipulative value than that generated by D action alone, to suppress the deviation increase. When the deviation becomes small, the behavior of P action becomes small.

A load including the integral component in the controlled system may oscillate due to the action of the integral component if P action alone is applied. In such a case, use PD control to reduce the oscillation caused by P action, for keeping the system stable. That is, PD control is applied to a system that does not contain any braking actions in its process.

(3) PID control

PID control is implemented by combining P action with the deviation suppression of I action and the oscillation suppression of D action. PID control features minimal control deviation, high precision and high stability.

In particular, PID control is effective to a system that has a long response time to the occurrence of deviation.

Follow the procedure below to set data to PID control function codes.

It is highly recommended that you adjust the PID control value while monitoring the system response waveform with an oscilloscope or equivalent. Repeat the following procedure to determine the optimal solution for each system.

- Increase the data of J03 (P (Gain) of PID control) within the range where the feedback signal does not oscillate.
- Decrease the data of J04 (I (Integral time) of PID control) within the range where the feedback signal does not oscillate.
- Increase the data of J05 (D (differential time) of PID control) within the range where the feedback signal does not oscillate.

Refining the system response waveforms is shown below.

1) Suppressing overshoot

Increase the data of J04 (Integral time) and decrease that of code J05 (Differential time)

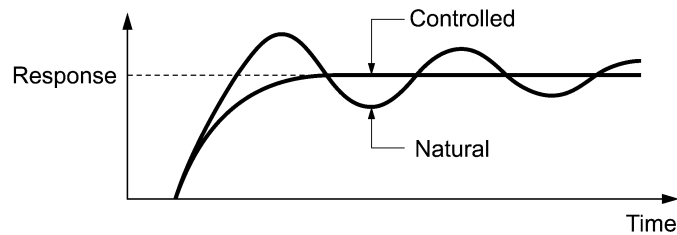

2) Quick stabilizing (moderate overshoot allowable)

Decrease the data of J03 (Gain) and increase that of code J05 (Differential time)

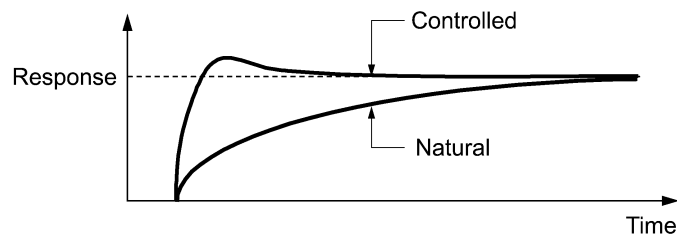

3) Suppressing oscillation longer than the integral time specified by J04

Increase the data of J04 (Integral time)

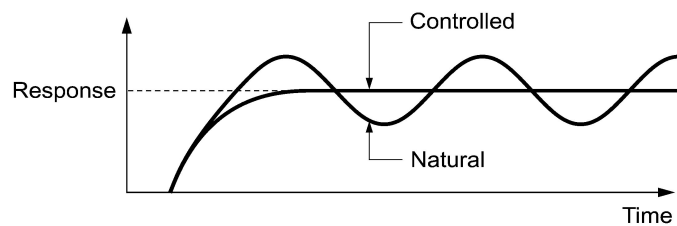

- 4) Suppressing oscillation of approximately same period as the time set for function code J05 (Differential time)

Decrease the data of J05 (Differential time).

Decrease the data of J03 (Gain), when the oscillation cannot be suppressed even if the differential time is set at 0 sec.

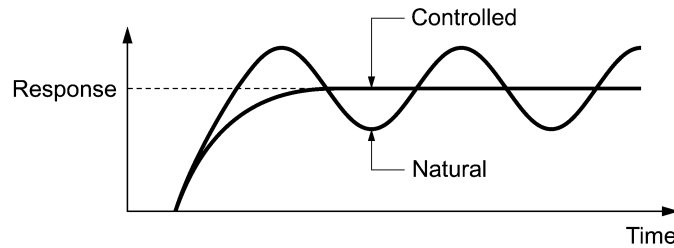

■ Feedback filter (J06)

J06 specifies the time constant of the filter for feedback signals under PID control.

- Data setting range: 0.0 to 900.0 (sec.)
- This setting is used to stabilize the PID control loop. Setting too long a time constant makes the system response slow.

J10	PID Control (Anti reset windup)
------------	--

J10 suppresses overshoot in control with PID processor. As long as the deviation between the feedback value and the PID process command is beyond the preset range, the integrator holds its value and does not perform integration operation.

- Data setting range: 0.0 to 200.0 (%)

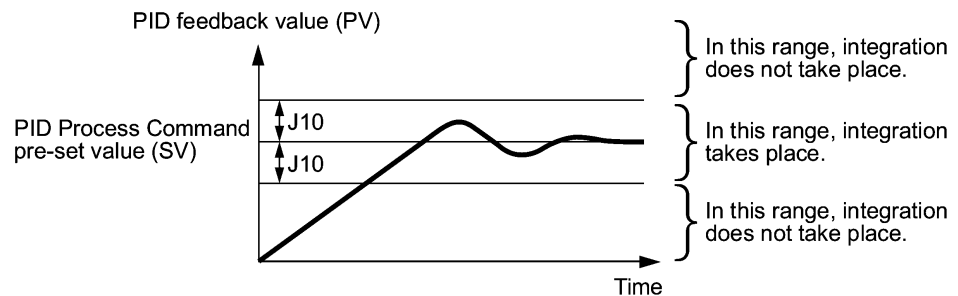

J11	PID Control (Select alarm output)
J12	PID Control (Upper limit alarm (AH))
J13	PID Control (Lower limit alarm (AL))

Two types of alarm signals can be output associated with PID control: absolute-value alarm and deviation alarm. You need to assign the PID alarm output (PID-ALM) to one of the digital output terminals (function code data = 42).

■ PID Control (Select alarm output) (J11)

Specifies the alarm type. The table below lists all the alarms available in the system.

Data for J11	Alarm	Description
0	Absolute-value alarm	While $PV < AL$ or $AH < PV$, (PID-ALM) is ON.
1	Absolute-value alarm (with Hold)	Same as above (with Hold)
2	Absolute-value alarm (with Latch)	Same as above (with Latch)
3	Absolute-value alarm (with Hold and Latch)	Same as above (with Hold and Latch)
4	Deviation alarm	While $PV < SV - AL$ or $SV + AH < PV$, (PID-ALM) is ON.
5	Deviation alarm (with Hold)	Same as above (with Hold)
6	Deviation alarm (with Latch)	Same as above (with Latch)
7	Deviation alarm (with Hold and Latch)	Same as above (with Hold and Latch)

Hold: During the power-on sequence, the alarm output is kept OFF (disabled) even when the monitored quantity is within the alarm range. Once it goes out of the alarm range, and comes into the alarm range again, the alarm is enabled.

Latch: Once the monitored quantity comes into the alarm range and the alarm is turned ON, the alarm will remain ON even if it goes out of the alarm range. To release the latch, perform a reset by using the key or turning ON the terminal command (RST), etc. Resetting can be done by the same way as resetting an alarm.

■ PID Control (Upper limit alarm (AH)) (J12)

Specifies the upper limit of the alarm (AH) in percentage (%) of the process value.

■ PID Control (Lower limit alarm) (AL)) (J13)

Specifies the lower limit of the alarm (AL) in percentage (%) of the process value.

Note The value displayed (%) is the ratio of the upper/lower limit to the full scale (10 V or 20 mA) of the feedback value (in the case of a gain of 100%).

Upper limit alarm (AH) and lower limit alarm (AL) also apply to the following alarms.

Alarm	Description	How to handle the alarm:	
		Select alarm output (J11)	Parameter setting
Upper limit (absolute)	ON when $AH < PV$	Absolute-value alarm	J13 (AL) = 0
Lower limit (absolute)	ON when $PV < AL$		J12 (AH) = 100%
Upper limit (deviation)	ON when $SV + AH < PV$	Deviation alarm	J13 (AL) = 100%
Lower limit (deviation)	ON when $PV < SV - AL$		J12 (AH) = 100%
Upper/lower limit (deviation)	ON when $ SV - PV > AL$		J13 (AL) = J12 (AH)
Upper/lower range limit (deviation)	ON when $SV - AL < PV < SV + AL$	Deviation alarm	(DO) inverted
Upper/lower range limit (absolute)	ON when $AL < PV < AH$	Absolute-value alarm	(DO) inverted
Upper/lower range limit (deviation)	ON when $SV - AL < PV < SV + AH$	Deviation alarm	(DO) inverted

J15	PID Control (Stop frequency for slow flowrate)
J16	PID Control (Slow flowrate level stop latency)
J17	PID Control (Starting frequency)

These function codes specify the data for the slow flowrate stop in pump control, a feature that stops the inverter when the discharge pressure rises, causing the volume of water to decrease.

■ Slow flowrate stop feature

When the discharge pressure has increased, decreasing the reference frequency (output of the PID processor) below the stop frequency for slow flowrate level (J15) for more than the elapsed stopping time on slow flowrate level stop latency (J16), the inverter decelerates to stop, while PID control itself continues to operate. When the discharge pressure decreases, increasing the reference frequency (output of the PID processor) above the starting frequency (J17), the inverter resumes operation.

If you wish to have a signal indicating the state in which the inverter is stopped due to the slow flowrate stop feature, you need to assign (PID-STP) (Inverter stopping due to slow flowrate under PID control) to one of the general-purpose output terminal (function code data = 44).

■ PID Control (Stop frequency for slow flowrate) (J15)

Specifies the frequency which triggers slow flowrate stop of inverter.

■ PID Control (Slow flowrate level stop latency) (J16)

Specifies the elapsed time from when the inverter stops operation due to slow flowrate level condition.

■ PID Control (Starting frequency) (J17)

Specifies the starting frequency. Select a frequency higher than the slow flowrate level stop frequency. If the specified starting frequency is lower than the slow flowrate level stop frequency, the latter stop frequency is ignored; the slow flowrate level stop is triggered when the output of the PID processor drops below the specified starting frequency.

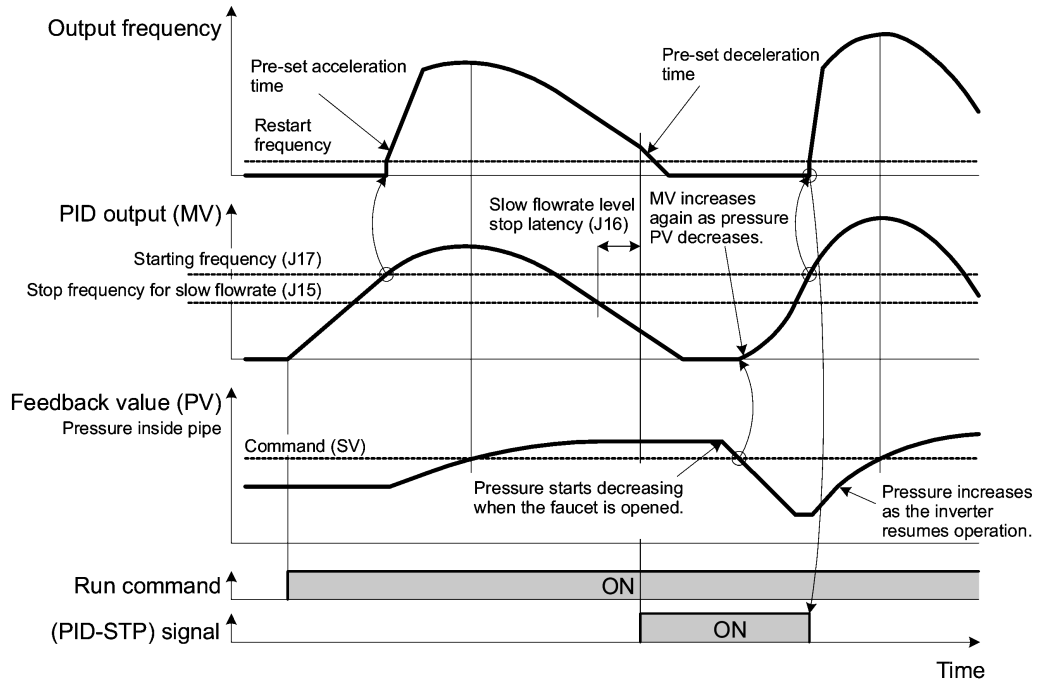

J18	PID Control (Upper limit of PID process output)
J19	PID Control (Lower limit of PID process output)

The upper and lower limiter can be specified to the PID output, exclusively used for PID control. The settings are ignored when PID cancel is enabled and the inverter is operated at the reference frequency previously specified.

■ PID Control (Upper limit of PID process output) (J18)

Specifies the upper limit of the PID processor output limiter in increments of 1 Hz. If you specify "999," the setting of the frequency limiter (High) (F15) will serve as the upper limit.

■ PID Control (Lower limit of PID process output) (J19)

Specifies the lower limit of the PID processor output limiter in increments of 1 Hz. If you specify "999," the setting of the frequency limiter (Low) (F16) will serve as the lower limit.

J21 Dew Condensation Prevention (Duty)

When the inverter is stopped, dew condensation on the motor can be prevented, by feeding DC power to the motor at regular intervals to keep the temperature of the motor above a certain level.

To utilize this feature, you need to assign a terminal command (DWP) (dew condensation prevention) to one of general-purpose digital input terminals (function code data = 39).

■ Enabling Dew Condensation Prevention

To enable dew condensation prevention, turn ON the condensation prevention command (DWP) while the inverter is stopped. Then, this feature starts.

■ Dew Condensation Prevention (Duty) (J21)

The magnitude of the DC power applied to the motor is the same as the setting of F21 (DC braking, Braking level) and its duration inside each interval is the same as the setting of F22 (DC braking, Braking time). The interval T is determined so that the ratio of the duration of the DC power to T is the value (Duty) set for J21.

$$\text{Duty for condensation prevention (J21)} = \frac{F22}{T} \times 100 (\%)$$

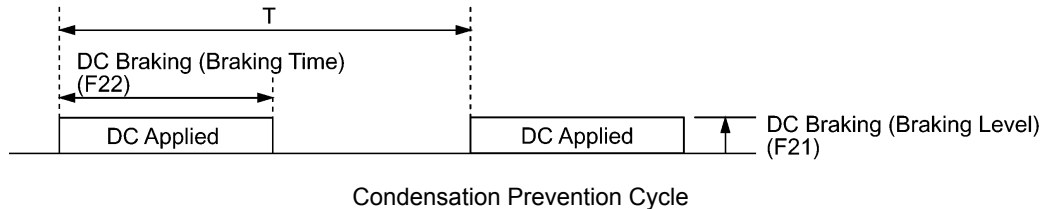

J22 Commercial Power Switching Sequence (Refer to E01 through E05.)

For how to set the commercial power switching sequence, refer to function codes E01 through E05.

9.2.7 y codes (Link functions)

Up to two ports of RS-485 communications link are available, including the terminal block option as shown below.

Port	Route	Function code	Applicable equipment
Port 1	Standard RS-485 Communications (for connection with keypad) via RJ-45 port	y01 through y10	Standard keypad Multi-function keypad PC running FRENIC Loader Host equipment
Port 2	Optional RS-485 communications card via the terminal port on the card	y11 through y20	Host equipment No FRENIC Loader supported

To connect any of the applicable devices, follow the procedures shown below.

(1) Standard keypad; Multi-function keypad (optional)

Both the standard keypad and the multi-function keypad (optional) allow you to run and monitor the inverter.

There is no need to set the y codes.

(2) FRENIC Loader

Using your PC running FRENIC Loader, you can monitor the inverter's running status information, edit function codes, and test-run the inverters.



For the setting of y codes, refer to function codes y01 to y10. For details, refer to the FRENIC Loader Instruction Manual (INR-SI47-0903-E).

(3) Host equipment

The inverter can be managed and monitored by connecting host equipment such as a PC and PLC to the inverter. Modbus RTU* and Fuji general-purpose inverter protocol are available for communications protocols.

*Modbus RTU is a protocol established by Modicon, Inc.



For details, refer to the RS-485 Communication User's Manual (MEH448).

y01 to y20	RS-485 Communication (Standard and option)
-------------------	---

■ Station Address (y01 for standard port and y11 for option port)

These function codes specify the station address for the RS-485 communications link. The table below lists the protocols and the station address setting ranges.

Protocol	Station address	Broadcast address
Modbus RTU protocol	1 to 247	0
FRENIC Loader protocol	1 to 255	None
FUJI general-purpose inverter protocol	1 to 31	99

- If any wrong address beyond the above range is specified, no response is returned since the inverter will be unable to receive any enquiries except the broadcast message.
- To use FRENIC Loader, set the station address that matches the connected PC.

■ Communications error processing (y02 for standard port and y12 for option port)

Set the operation performed when an RS-485 communications error has occurred.

RS-485 communications errors contain logical errors such as address error, parity error, framing error, and transmission protocol error, and physical errors such as communications disconnection error set by y08 and y18. In each case, these are judged as an error only when the inverter is running while the operation command or frequency command has been set to the configuration specified through RS-485 communications. When neither the operation command nor frequency command is issued through RS-485 communications, or the inverter is not running, error occurrence is not recognized.

Data for y02 and y12	Function
0	Immediately trip after showing an RS-485 communications error (E_r-B for y02 and E_r-P for y12). (The inverter stops with alarm issue.)
1	Run during the time set on the error processing timer (y03, y13), display an RS-485 communications error (E_r-B for y02 and E_r-P for y12), and then stop operation. (The inverter stops with alarm issue.)
2	Retry transmission during the time set on the error processing timer (y03, y13). If communications link is recovered, continue operation. Otherwise, display an RS-485 communications error (E_r-B for y02 and E_r-P for y12) and stop operation. (The inverter stops with alarm issue.)
3	Continue to run even when a communications error occurs.

For details, refer to the RS-485 Communication User's Manual (MEH448).

■ Error processing timer (y03 and y13)

y03 or y13 specifies an error processing timer.

When the set timer count has elapsed because of no response on other end etc., if a response request was issued, the inverter interprets that an error occurs. See the section of "No-response error detection time (y08, y18)."

- Data setting range: 0.0 to 60.0 (sec.)

■ **Transmission speed (y04 and y14)**

Select the transmission speed for RS-485 communications.

- Setting for FRENIC Loader: Set the same transmission speed as that specified by the connected PC.

Data for y04 and y14	Transmission speed (bps)
0	2400
1	4800
2	9600
3	19200
4	38400

■ **Data length (y05 and y15)**

Select the character length for transmission.

- Setting for FRENIC Loader: Loader sets the length in 8 bits automatically. (The same applies to the Modbus RTU protocol.)

Data for y05 and y15	Data length
0	8 bits
1	7 bits

■ **Parity check (y06 and y16)**

Select the property of the parity bit.

- Setting for FRENIC Loader: Loader sets it to the even parity automatically.

Data for y06 and y16	Parity
0	None
1	Even parity
2	Odd parity

■ **Stop bits (y07 and y17)**

Select the number of stop bits.

- Setting for FRENIC Loader: Loader sets it to 1 bit automatically.
For the Modbus RTU protocol, the stop bits are automatically determined associated with the property of parity bits. So no setting is required.

Data for y07 and y17	Stop bit(s)
0	2 bits
1	1 bit

■ **No-response error detection time (y08 and y18)**

Set the time interval from the inverter detecting no access until it enters communications error alarm mode due to network failure and processes the communications error. This applies to a mechanical system that always accesses its station within a predetermined interval during communications using the RS-485 communications link.

For the processing of communications errors, refer to y02 and y12.

Data for y08 and y18	Function
0	Disable
1 to 60	1 to 60 sec.

■ Response latency time (y09 and y19)

Sets the latency time after the end of receiving a query sent from the host equipment (such as a PC or PLC) to the start of sending the response. This function allows using equipment whose response time is slow while a network requires quick response, enabling the equipment to send a response timely by the latency time setting.

- Data setting range: 0.00 to 1.00 (sec.)

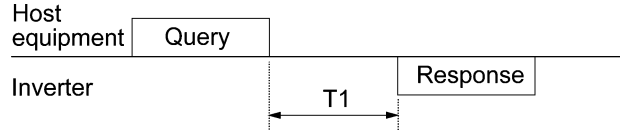

$T1 = \text{Latency time} + \alpha$

where α is the processing time inside the inverter. This time may vary depending on the processing status and the command processed in the inverter.

For details, refer to the RS-485 Communication User's Manual (MEH448).

Note When setting the inverter with FRENIC Loader, pay sufficient attention to the performance and/or configuration of the PC and protocol converter such as RS-485–RS-232C communications level converter. Note that some protocol converters monitor the communications status and switch the send/receive of transmission data by a timer.

■ Protocol selection (y10)

Select the communications protocol for the standard RS-485 port.

- Specifying FRENIC loader to connect to the inverter can only be made by y10. Select FRENIC Loader (y10 = 1).

Data for y10	Protocol
0	Modbus RTU protocol
1	FRENIC Loader protocol
2	Fuji general-purpose inverter protocol

■ Protocol selection (y20)

Select the communications protocol for the optional communications port.

Data for y20	Protocol
0	Modbus RTU protocol
2	Fuji general-purpose inverter protocol

y98	Bus Link Function (Mode selection)	(Refer to H30.)
------------	---	------------------------

For how to set y98 bus link function (Mode selection), refer to the description of function code H30.

y99**Loader Link Function (Mode selection)**

This is a link switching function for FRENIC Loader. Rewriting the data of this function code y99 (= 3) to enable RS-485 communications from Loader helps Loader send the inverter the frequency and run commands. Since the data in the function code of the inverter is automatically set by Loader, no keypad operation is required. While Loader is selected as the source of the run command, if the PC runs out of control and cannot be stopped by a stop command sent from Loader, disconnect the RS-485 communications cable from the standard port (Keypad), connect a keypad instead, and reset the y99 to "0." This setting "0" in y99 means that the run and frequency command source specified by function code H30 takes place.

Note that the inverter cannot save the setting of y99. When power is turned off, the data in y99 is lost (y99 is reset to "0").

Data for y99	Function	
	Frequency command	Run command
0	Follow H30 and y98 data	Follow H30 and y98 data
1	Via RS-485 communications link (FRENIC Loader, S01 and S05)	Follow H30 and y98 data
2	Follow H30 and y98 data	Via RS-485 communications link (FRENIC Loader, S06)
3	Via RS-485 communications link (FRENIC Loader, S01 and S05)	Via RS-485 communications link (FRENIC Loader, S06)

Chapter 10

TROUBLESHOOTING

This chapter describes troubleshooting procedures to be followed when the inverter malfunctions or detects an alarm condition. In this chapter, first check whether any alarm code is displayed or not, and then proceed to the troubleshooting items.

Contents

10.1 Before Proceeding with Troubleshooting	10-1
10.2 If No Alarm Code Appears on the LED Monitor.....	10-2
10.2.1 Motor is running abnormally	10-2
10.2.2 Problems with inverter settings.....	10-7
10.3 If an Alarm Code Appears on the LED Monitor.....	10-8
10.4 If an Abnormal Pattern Appears on the LED Monitor while No Alarm Code is Displayed.....	10-19

10.1 Before Proceeding with Troubleshooting

WARNING

If any of the protective functions have been activated, first remove the cause. Then, after checking that the all run commands are set to off, reset the alarm. Note that if the alarm is reset while any run commands are set to on, the inverter may supply the power to the motor which may cause the motor to rotate.

Injury may occur.

- Even though the inverter has interrupted power to the motor, if the voltage is applied to the main circuit power input terminals L1/R, L2/S and L3/T, voltage may be output to inverter output terminals U, V, and W.
- Turn OFF the power and wait more than five minutes for models of 30 kW or below, or ten minutes for models of 37 kW or above. Make sure that the LED monitor and charging lamp (on models of 37 kW or above) are turned OFF. Further, make sure, using a multimeter or a similar instrument, that the DC link bus voltage between the terminals P (+) and N (-) has dropped below the safe voltage (+25 VDC).

Electric shock may occur.

Follow the procedure below to solve problems.

- (1) First, check that the inverter is correctly wired, referring to the Instruction Manual (INR-SI47-1059-E), Chapter 2 Section 2.3.6 "Wiring for main circuit terminals and grounding terminals."
- (2) Check whether an alarm code is displayed on the LED monitor.

● No alarm code appears on the LED monitor

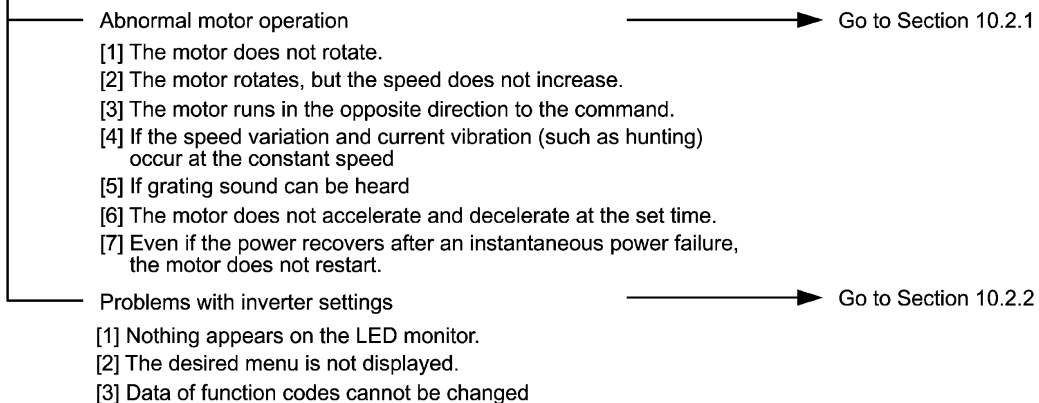

● If an alarm code appears on the LED monitor —————▶ Go to Section 10.3

● If an abnormal pattern appears on the LED monitor while no alarm code is displayed —————▶ Go to Section 10.4

If any problems persist after the above recovery procedure, contact your Fuji Electric representative.

10.2 If No Alarm Code Appears on the LED Monitor

10.2.1 Motor is running abnormally

[1] The motor does not rotate.

Possible Causes	What to Check and Suggested Measures
(1) No power supplied to the inverter.	<p>Check the input voltage, output voltage and interphase voltage unbalance.</p> <ul style="list-style-type: none"> → Turn ON a molded case circuit breaker, an earth leakage circuit breaker (with overcurrent protection) or a magnetic contactor. → Check for voltage drop, phase loss, poor connections, or poor contacts, and fix them if necessary. → If only auxiliary control power is supplied, turn ON the main power.
(2) No forward/reverse operation command was inputted, or both the commands were inputted simultaneously (external signal operation).	<p>Check the input status of the forward/reverse command with Menu #4 "I/O Checking" using the keypad.</p> <ul style="list-style-type: none"> → Input a run command. → Set either the forward or reverse operation command to off if both commands are being inputted. → Correct the assignment of commands (FWD) and (REV) to function codes E98 and E99. → Connect the external circuit wires to control circuit terminals [FWD] and [REV] correctly. → Make sure that the sink/source slide switch on the printed circuit board is properly configured.
(3) No indication of rotation direction (keypad operation).	<p>Check the input status of the forward/reverse rotation direction command with Menu #4 "I/O Checking" using the keypad.</p> <ul style="list-style-type: none"> → Input the rotation direction (F02=0), or select the keypad operation with which the rotation direction is fixed (F02=2 or 3).
(4) The inverter could not accept any run commands from the keypad since it was in Programming mode.	<p>Check which operation mode the inverter is in, using the keypad.</p> <ul style="list-style-type: none"> → Shift the operation mode to Running mode and enter a run command.
(5) A run command with higher priority than the one attempted was active, and the run command was stopped.	<p>While referring to the block diagram of the drive command generator*, check the higher priority run command with Menu #2 "Data Checking" and Menu #4 "I/O Checking" using the keypad.</p> <p>*Refer to Chapter 4.</p> <ul style="list-style-type: none"> → Correct any incorrect function code data settings (in H30, y98, etc.) or cancel the higher priority run command.
(6) The frequency command was set below the starting or stop frequency.	<p>Check that a frequency command has been entered, with Menu #4 "I/O Checking" using the keypad.</p> <ul style="list-style-type: none"> → Set the value of the frequency command to the same or higher than that of the starting or stop frequency (F23 or F25). → Reconsider the starting and stop frequencies (F23 and F25), and if necessary, change them to lower values. → Inspect the frequency command, signal converters, switches, or relay contacts. Replace any ones that are faulty. → Connect the external circuit wires correctly to terminals [13], [12], [11], [C1], and [V2].
(7) A frequency command with higher priority than the one attempted was active.	<p>Check the higher priority run command with Menu #2 "Data Checking" and Menu #4 "I/O Checking" using the keypad, referring to the block diagram of the drive command generator*.</p> <p>*Refer to Chapter 4.</p> <ul style="list-style-type: none"> → Correct any incorrect function code data settings (e.g. cancel the higher priority run command).
(8) The upper and lower frequencies for the frequency limiters were set incorrectly.	<p>Check the data of function codes F15 (Frequency limiter (high)) and F16 (Frequency limiter (low)).</p> <ul style="list-style-type: none"> → Change the settings of F15 and F16 to the correct ones.





Possible Causes	What to Check and Suggested Measures
(9) The coast-to-stop command was effective.	Check the data of function codes E01, E02, E03, E04, E05, E98 and E99 and the input signal status with Menu #4 "I/O Checking" using the keypad. → Release the coast-to-stop command setting.
(10) Broken wire, incorrect connection or poor contact with the motor.	Check the cabling and wiring (Measure the output current). → Repair the wires to the motor, or replace them.
(11) Overload	Measure the output current. → Lighten the load (In winter, the load tends to increase.)
	Check that a mechanical brake is in effect. → Release the mechanical brake, if any.
(12) Torque generated by the motor was insufficient.	Check that the motor starts running if the value of torque boost (F09) is increased. → Increase the value of torque boost (F09) and try to run the motor.
	Check the data of function codes F04, F05, H50, and H51. → Change the V/f pattern to match the motor's characteristics.
	Check whether the frequency command signal is below the slip-compensated frequency of the motor. → Change the frequency command signal so that it becomes higher than the slip-compensated frequency of the motor.
(13) Miss-/weak-connection of the DC reactor (DCR)	Check the wiring connection. A DC reactor is built-in for 75 kW or above models. FRENIC-Eco inverter cannot run without a DC reactor. → Connect the DC reactor correctly. Repair or replace wires for the DC reactor.

[2] The motor rotates, but the speed does not increase.

Possible Causes	What to Check and Suggested Measures
(1) The maximum frequency currently specified was too low.	Check the data of function code F03 (Maximum frequency). → Readjust the data of F03.
(2) The data of frequency limiter currently specified was too low.	Check the data of function code F15 (Frequency limiter (high)). → Readjust the data of F15.
(3) The reference frequency currently specified was too low.	Check the signals for the frequency command from the control circuit terminals with Menu #4 "I/O Checking" on the keypad. → Increase frequency of the command. → If an external potentiometer for frequency command, signal converter, switches, or relay contacts are malfunctioning, replace them. → Connect the external circuit wires to terminals [13], [12], [11], [C1], and [V2] correctly.
(4) A frequency command (e.g., multistep frequency or via communications) with higher priority than the one expected was active and its reference frequency was too low.	Check the data of the relevant function codes and what frequency commands are being received, through Menu #1 "Data Setting," Menu #2 "Data Checking" and Menu #4 "I/O Checking," on the keypad by referring to the block diagram of the frequency command*. *Refer to Chapter 4. → Correct any incorrect data of function code (e.g. The higher priority run command is mistakenly canceled, etc.).
(5) The acceleration time was too long.	Check the data of function code F07 (Acceleration time 1) → Change the acceleration/deceleration time to match the load.

Possible Causes	What to Check and Suggested Measures
(6) Overload	<p>Measure the output current.</p> <p>→ Lighten the load.</p> <p>Check if mechanical brake is working.</p> <p>→ Release the mechanical brake (Adjust the dumper of the fan or the valve of the pump). (In winter, the load tends to increase.)</p>
(7) Mismatch with the characteristics of the motor	<p>In case auto-torque boost or auto-energy saving operation is under way, check whether P02, P03, P06, P07, and P08 agree with the parameters of the motor.</p> <p>→ Set P02, P03, and P06 properly and perform auto-tuning in accordance with P04.</p>
(8) The current limiting operation did not increase the output frequency.	<p>Make sure that F43 (Current limiter (mode selection)) is set to "2" and check the setting of F44 (Current limiter (level)).</p> <p>→ If the current limiting operation is not needed, set F43 to "0" (disabled).</p>
	<p>Decrease the value of torque boost (F09), then turn the power OFF and back on again and check if the speed increases.</p> <p>→ Adjust the value of the torque boost (F09).</p>
	<p>Check the data of function codes F04, F05, H50, and H51 to ensure that the V/f pattern is right.</p> <p>→ Match the V/f pattern values with the motor ratings.</p>
(9) Bias and gain set incorrectly.	<p>Check the data of function codes F18, C50, C32, C34, C37, C39, C42, and C44.</p> <p>→ Readjust the bias and gain to appropriate values.</p>

[3] The motor runs in the opposite direction to the command.

Possible Causes	What to Check and Suggested Measures
(1) Wiring has been connected to the motor incorrectly.	<p>Check the wiring to the motor.</p> <p>→ Connect terminals U, V, and W of the inverter to the respective U, V, and W terminals of the motor.</p>
(2) Incorrect connection and settings for run commands and rotation direction command (FWD) and (REV)	<p>Check the data of function codes E98 and E99 and the connection to terminals [FWD] and [REV].</p> <p>→ Correct the data of the function codes and the connection.</p>
(3) The setting for the rotation direction via keypad operation is incorrect.	<p>Check the data of function code F02 (Run command).</p> <p>→ Change the data of function code F02 to "2: Enable  /  keys on keypad (forward)" or "3: Enable  /  keys on keypad (reverse)."</p>

[4] If the speed variation and current vibration (such as hunting) occur at the constant speed

Possible Causes	What to Check and Suggested Measures
(1) The frequency command fluctuated.	<p>Check the signals for the frequency command with Menu #4 "I/O Checking" using the keypad.</p> <p>→ Increase the filter constants (C33, C38, and C43) for the frequency command.</p>

Possible Causes	What to Check and Suggested Measures
(2) The external frequency command source device was used.	<p>Check that there is no noise in the control signal wires from external sources.</p> <ul style="list-style-type: none"> → Isolate the control signal wires from the main circuit wires as far as possible. → Use shielded or twisted wires for the control signal.
	<p>Check whether the frequency command source has not failed because of noise from the inverter.</p> <ul style="list-style-type: none"> → Connect a capacitor to the output terminal of the frequency command source or insert a ferrite core in the signal wire. (Refer to the Instruction Manual (INR-SI47-1059-E), Chapter 2 Section 2.3.7 "Wiring for control circuit terminals.")
(3) Frequency switching or multistep frequency command was enabled.	<p>Check whether the relay signal for switching the frequency command is chattering.</p> <ul style="list-style-type: none"> → If the relay has a contact problem, replace the relay.
(4) The connection between the inverter and the motor was too long.	<p>Check whether auto-torque boost or auto-energy saving operation is enabled.</p> <ul style="list-style-type: none"> → Set P02, P03, and P06 properly and perform auto-tuning in accordance with P04. → Enable load selection for higher startup torque (F37 = 1) and check for any vibration. → Make the output wire as short as possible.
(5) The inverter output is hunting due to vibration caused by low stiffness of the load. Or the current is irregularly oscillating due to special motor parameters.	<p>Cancel the automatic control system--automatic torque boost and energy saving operation (F37), overload prevention control (H70), and current limiter (F43), then check that the motor vibration is suppressed.</p> <ul style="list-style-type: none"> → Cancel the functions causing the vibration. → Readjust the data of the oscillation suppression gain (H80) currently set to appropriate values.
	<p>Check that the motor vibration is suppressed if you decrease the level of F26 (Motor sound (carrier frequency)) or set F27 (Motor sound (tone)) to "0".</p> <ul style="list-style-type: none"> → Decrease the carrier frequency (F26) or set the tone to "0" (F27=0).

[5] If grating sound can be heard from motor

Possible Causes	What to Check and Suggested Measures
(1) The carrier frequency was set too low.	<p>Check the data of function codes F26 (Motor sound (carrier frequency)) and F27 (Motor sound (tone)).</p> <ul style="list-style-type: none"> → Increase the carrier frequency (F26). → Readjust the setting of F27 to appropriate value.
(2) The ambient temperature of the inverter was too high (when automatic lowering of the carrier frequency was enabled by H98).	<p>Measure the temperature inside the enclosure of the inverter.</p> <ul style="list-style-type: none"> → If it is over 40°C, lower it by improving the ventilation. → Lower the temperature of the inverter by reducing the load. (In the case of a fan or a pump, lower the setting data of the frequency limiter (F15).) <p>Note: If you disable H98, an <i>OH1</i>, <i>OH3</i> or <i>OLU</i> alarm may occur.</p>
(3) Resonance with the load	<p>Check the precision of the mounting of the load or check whether there is resonance with the enclosure or likes.</p> <ul style="list-style-type: none"> → Disconnect the motor and run it without the inverter, and determine where the resonance comes from. Upon locating the cause, improve the characteristics of the source of the resonance. → Adjust the settings of C01 (Jump frequency 1) to C04 (Jump frequency (band)) so as to avoid continuous running in the frequency range causing resonance.

[6] The motor does not accelerate and decelerate at the set time.

Possible Causes	What to Check and Suggested Measures
(1) The inverter ran the motor by S-curve or curvilinear pattern.	Check the data of function code H07 (Acceleration/deceleration pattern). → Select the linear pattern (H07 = 0). → Shorten the acceleration/deceleration time (F07, F08).
(2) The current limiting prevented the output frequency from increasing (during acceleration).	Make sure that F43 (Current limiter (mode selection)) is set to "2: Enable during acceleration and at constant speed," then check that the setting of F44 (Current limiter (level)) is reasonable. → Readjust the setting of F44 to appropriate value, or disable the function of current limiter in F43. → Increase the acceleration/deceleration time (F07/F08).
(3) The automatic regenerative braking was active.	Check the data of function code H69 (Automatic deceleration). → Increase the deceleration time (F08).
(4) Overload	Measure the output current. → Lighten the load (In the case of a fan or a pump load, lower the setting data of the F15 (Frequency limiter (high)). (In winter, the load tends to increase.)).
(5) Torque generated by the motor was insufficient.	Check that the motor starts running if the value of the torque boost (F09) is increased. → Increase the value of the torque boost (F09).
(6) An external frequency command is being used.	Check that there is no noise in the external signal wires. → Isolate the control signal wires from the main circuit wires as far as possible. → Use shielded wire or twisted wire for the control signal wires. → Connect a capacitor to the output terminal of the frequency command or insert a ferrite core in the signal wire. (Refer to the Instruction Manual (INR-SI47-1059-E), Chapter 2 Section 2.3.7 "Wiring for control circuit terminals.")
(7) The V2/PTC switch was turned to PTC (when V2 was being used).	Check whether control terminal [V2] is not set to the PTC thermistor input mode. → Turn the V2/PTC switch on the printed circuit board to V2.

[7] Even if the power recovers after a momentary power failure, the motor does not restart.

Possible Causes	What to Check and Suggested Measures
(1) The data of function code F14 is either 0 or 1.	Check if an undervoltage trip occurs. → Change the data of function code F14 (Restart mode after momentary power failure (mode selection)) to 3, 4 or 5.
(2) The run command stayed off even after power has been restored.	Check the input signal with Menu #4 "I/O Checking" using the keypad. → Check the power recovery sequence with an external circuit. If necessary, consider the use of a relay that can keep the run command on. While in 3-wire operation, the power source to the inverter's control circuit went down because of a long momentary power failure; or, the (HOLD) signal was turned OFF once. → Change the design or the setting so that a run command can be issued again within 2 seconds after power has been restored.

10.2.2 Problems with inverter settings



[1] Nothing appears on the LED monitor.

Possible Causes	What to Check and Suggested Measures
(1) No power supplied to the inverter (main circuit power, auxiliary power for control circuit).	<p>Check the input voltage, output voltage and interphase voltage unbalance.</p> <p>→ Connect a molded case circuit breaker, an earth leakage circuit breaker (with overcurrent protection) or a magnetic contactor.</p> <p>→ Check for voltage drop, phase loss, poor connections, or poor contacts, and fix them if necessary.</p>
(2) The power for the control circuit did not reach a high enough level.	<p>Check if the short bar has been removed between terminals P1 and P (+) or if there is poor contact between the short bar and the terminals.</p> <p>→ Connect the short bar or DC reactor between terminals P1 and P (+) or retighten the screws.</p>
(3) The keypad was not properly connected to the inverter.	<p>Check whether the keypad is properly connected to the inverter.</p> <p>→ Remove the keypad, put it back, and see whether the problem persists.</p> <p>→ Replace the keypad with another one and check whether the problem persists.</p>
	<p>When running the inverter remotely, ensure that the extension cable is securely connected both to the keypad and to the inverter.</p> <p>→ Disconnect the cable, reconnect it, and see whether the problem persists.</p> <p>→ Replace the keypad with another one and check whether the problem persists.</p>

[2] The desired menu is not displayed.

Causes	Check and Measures
(1) The limiting menus function was not selected appropriately.	<p>Check the data of function code E52 (Keypad (menu display mode)).</p> <p>→ Change the data of function code E52 so that the desired menu can be displayed.</p>

[3] Data of function codes cannot be changed

Possible Causes	What to Check and Suggested Measures
(1) An attempt was made to change function code data that cannot be changed when the inverter is running.	<p>Check if the inverter is running with Menu #3 "Drive Monitoring" using the keypad and then confirm whether the data of the function codes can be changed when the motor is running by referring to the function code tables.</p> <p>→ Stop the motor then change the data of the function codes.</p>
(2) The data of the function codes is protected.	<p>Check the data of function code F00 (Data protection).</p> <p>→ Change the setting of F00 from "1" to "0."</p>
(3) The WE-KP command ("Enable editing of function code data from keypad") is not input though it has been assigned to a digital input terminal.	<p>Check the data of function codes E01, E02, E03, E04, E05, E98 and E99 and the input signals with Menu #4 "I/O Checking" using the keypad.</p> <p>→ Change the setting of F00 from "1" to "0," or input a WE-KP command through a digital input terminal.</p>
(4) The  key was not pressed.	<p>Check whether you have pressed the  key after changing the function code data.</p> <p>→ Press the  key after changing the function code data.</p>
(5) The setting data of function code F02 could not be changed.	<p>The inputs to the terminals of (FWD) and (REV) commands are concurrently turned ON.</p> <p>→ Turn OFF both (FWD) and (REV).</p>

10.3 If an Alarm Code Appears on the LED Monitor

■ Quick reference table of alarm codes

Alarm code	Name	Refer to	Alarm code	Name	Refer to
<i>OC1</i>	Instantaneous overcurrent	10-8	<i>FUS</i>	Fuse blown	10-13
<i>OC2</i>			<i>PbF</i>	Charger circuit fault	10-13
<i>OC3</i>			<i>OL1</i>	Electronic thermal overload relay	10-14
<i>EF</i>	Ground fault	10-9	<i>OLU</i>	Overload	10-14
<i>OU1</i>	Overvoltage	10-9	<i>Er1</i>	Memory error	10-15
<i>OU2</i>			<i>Er2</i>	Keypad communications error	10-15
<i>OU3</i>			<i>Er3</i>	CPU error	10-15
<i>LU</i>	Undervoltage	10-10	<i>Er4</i>	Option card communications error	10-16
<i>L in</i>	Input phase loss	10-10	<i>Er5</i>	Option card error	10-16
<i>OPL</i>	Output phase loss	10-11	<i>Er6</i>	Incorrect operation error	10-16
<i>OH1</i>	Heat sink overheat	10-11	<i>Er7</i>	Tuning error	10-17
<i>OH2</i>	Alarm issued by an external device	10-12	<i>Er8</i>	RS-485 communications error	10-17
<i>OH3</i>	Inside of the inverter overheat	10-12	<i>ErF</i>	Data saving error during undervoltage	10-18
<i>OH4</i>	Motor protection (PTC thermistor)	10-12	<i>ErP</i>	RS-485 communications error (Option card)	10-18
			<i>ErH</i>	LSI error (Power PCB)	10-19

[1] *OCn* Instantaneous overcurrent

Problem The inverter momentary output current exceeded the overcurrent level.

OC1 Overcurrent occurred during acceleration.

OC2 Overcurrent occurred during deceleration.

OC3 Overcurrent occurred when running at a constant speed.

Possible Causes	What to Check and Suggested Measures
(1) The inverter output terminals were short-circuited.	Remove the wires connected to the inverter output terminals (U, V, and W) and measure the interphase resistance of the wires. Check if the resistance is too low. → Remove the part that short-circuited (including replacement of the wires, relay terminals and motor).
(2) Ground faults occurred at the inverter output terminals.	Remove the wires connected to the inverter output terminals (U, V, and W) and perform a Megger test. → Remove the part that short-circuited (including replacement of the wires, relay terminals and motor).
(3) Loads were too heavy.	Measure the motor current with a measuring device, and to trace the current trend. Therefore, use this information to judge if the trend is over the calculated load value for your system design. → If the load is too heavy, decrease it or raise the inverter capacity.
	Trace the current trend and check if there are any sudden changes in the current. → If there are any sudden changes, make the load variation smaller or raise the inverter capacity. → Enable instantaneous overcurrent limiting (H12 = 1).

Possible Causes	What to Check and Suggested Measures
(4) The value set for torque boost (F09) was too large. (F37 = 0, 1, 3, or 4)	Check that the output current decreases and the motor does not come to stall if you set a lower value than the current one for F09. → Lower the value for torque boost (F09) if the motor is not going to stall.
(5) The acceleration/ deceleration time was too short.	Check that the motor generates enough torque required during acceleration/deceleration. That torque is calculated from the moment of inertia for the load and the acceleration/deceleration time. → Increase the acceleration/deceleration time (F07 and F08). → Enable current limitig (F43). → Raise the inverter capacity.
(6) Malfunction caused by noise	Check if noise control measures are appropriate (e.g., correct grounding and routing of control and main circuit wires). → Implement noise control measures. For details, refer to "Appendix A." → Enable the auto-resetting (H04). → Connect a surge absorber to the coil or solenoid of the magnetic contactor causing the noise.

[2] EF Ground fault (90 kW or above)

Problem A ground fault current flew from the output terminal of the inverter.

Possible Causes	What to Check and Suggested Measures
(1) The output terminal of the inverter is short-circuited to the ground (ground fault, or earthed).	Disconnect the wires from the output terminals ([U], [V], and [W]) and perform a megger test. → Remove the earthed path (including the replacement of the wires, the terminals, or the motor as necessary).

[3] OLn Overvoltage

Problem The DC link bus voltage was over the detection level of overvoltage.

- OL1 Overvoltage occurs during the acceleration.
- OL2 Overvoltage occurs during the deceleration.
- OL3 Overvoltage occurs during running at constant speed.

Possible Causes	What to Check and Suggested Measures
(1) The power supply voltage was over the range of the inverter's specifications.	Measure the input voltage. → Decrease the voltage to within that of the specifications.
(2) A surge current entered the input power source.	If within the same power source a phase-advancing capacitor is turned ON or OFF or a thyristor converter is activated, a surge (temporary precipitous rise in voltage or current) may be caused in the input power. → Install a DC reactor.
(3) The deceleration time was too short for the moment of inertia for load.	Recalculate the deceleration torque from the moment of inertia for load and the deceleration time. → Increase the deceleration time (F08). → Enable the regenerative braking (H69 = 3), or automatic deceleration (H71 = 1). → Set the rated voltage (at base frequency) (F05) to "0" to improve braking ability.
(4) The acceleration time was too short.	Check if the overvoltage alarm occurs after rapid acceleration. → Increase the acceleration time (F07). → Select the S-curve pattern (H07).

Possible Causes	What to Check and Suggested Measures
(5) Braking load was too heavy.	Compare the braking torque of the load with that of the inverter. → Set the rated voltage (at base frequency) (F05) to 0 to improve braking ability.
(6) Malfunction caused by noise.	Check if the DC link bus voltage was below the protective level when the alarm occurred. → Improve noise control. For details, refer to "Appendix A." → Enable the auto-resetting (H04). → Connect a surge absorber to the coil or solenoid of the magnetic contactor causing the noise.

[4] Undervoltage

Problem DC link bus voltage was below the undervoltage detection level.

Possible Causes	What to Check and Suggested Measures
(1) A momentary power failure occurred.	→ Reset the alarm. → If you want to restart running the motor by not treating this condition as an alarm, set F14 to "3," "4" or "5," depending on the load.
(2) The power to the inverter was switched back on too soon (with F14 = 1).	Check if the power to the inverter was switched back on although its control circuit was still operating. → Switch ON the power again after the display on the keypad has disappeared.
(3) The power supply voltage did not reach the range of the inverter's specifications.	Measure the input voltage. → Increase the voltage to within that of the specifications.
(4) Peripheral equipment for the power circuit malfunctioned, or the connection was incorrect.	Measure the input voltage to find where the peripheral equipment malfunctioned or which connection is incorrect. → Replace any faulty peripheral equipment, or correct any incorrect connections.
(5) Other loads were connected to the same power source and required a large current to start running to the extent that it caused a temporary voltage drop on the supply side.	Measure the input voltage and check the voltage variation. → Reconsider the power system configuration.
(6) Inverter's inrush current caused the power voltage drop because power transformer capacity was insufficient.	Check if the alarm occurs when you switch on a molded case circuit breaker, an earth leakage circuit breaker (with overcurrent protection) or a magnetic contactor. → Reconsider the capacity of the power source transformer.

[5] Input phase loss

Problem Input phase loss occurred, or interphase voltage unbalance rate was large.

Possible Causes	What to Check and Suggested Measures
(1) Main circuit power input wires broken.	Measure the input voltage. → Repair or replace the wires.
(2) The terminal screws for the main circuit power input of the inverter were not tight enough.	Check if the screws on the inverter input terminals have become loose. → Tighten the terminal screws to the recommended torque.

Possible Causes	What to Check and Suggested Measures
(3) Interphase unbalance rate of three-phase voltage was too large.	Measure the input voltage. → Connect an AC reactor (ACR) to lower the voltage unbalance between input phases. → Raise the inverter capacity.
(4) Overload cyclically occurred.	Measure ripple wave of DC link bus voltage. → If the ripple is large, raise the inverter capacity
(5) Single-phase voltage was input to the inverter instead of three-phase voltage input.	Check the inverter type. → Apply three-phase power. FRENIC-Eco cannot be driven by single-phase power source.

 **Note** You can disable input phase loss protection using the function code H98.

[6] *OPL* Output phase loss

Problem Output phase loss occurred.

Possible Causes	What to Check and Suggested Measures
(1) Inverter output wires are broken.	Measure the output current. → Replace the output wires.
(2) Wires for motor winding are broken.	Measure the output current. → Replace the motor.
(3) The terminal screws for inverter output were not tight enough.	Check if any screws on the inverter output terminals have become loose. → Tighten the terminal screws to the recommended torque.
(4) A single-phase motor has been connected.	→ Single-phase motors cannot be used. Note that the FRENIC-Eco only drives three-phase induction motors.

[7] *OHI* Heat sink overheat

Problem Temperature around heat sink rose.

Possible Causes	What to Check and Suggested Measures
(1) Temperature around the inverter exceeded that of inverter specifications.	Measure the temperature around the inverter. → Lower the temperature around the inverter (e.g., ventilate the enclosure well).
(2) Air vent is blocked.	Check if there is sufficient clearance around the inverter. → Increase the clearance.
	Check if the heat sink is not clogged. → Clean the heat sink.
(3) Accumulated running time of the cooling fan exceeded the standard period for replacement, or the cooling fan malfunctioned.	Check the cumulative running time of the cooling fan. Refer to the Instruction Manual (INR-SI47-1059-E), Chapter 3, Section 3.4.6 "Reading maintenance information – "Maintenance Information"." → Replace the cooling fan.
	Visually check whether the cooling fan rotates abnormally. → Replace the cooling fan.
(4) Load was too heavy.	Measure the output current. → Lighten the load (e.g. lighten the load before the overload protection occurs using the overload early warning (E34). (In winter, the load tends to increase.) → Decrease the motor sound (carrier frequency) (F26). → Enable the overload protection control (H70).

Note The 200V series inverters with a capacity of 45 kW or above and the 400V series inverters with a capacity of 55 kW or above each have a cooling fan/fans for heat sinks and a DC fan for internal air circulation (dispersing the heat generated inside the inverter). For their locations, refer to the Instruction Manual (INR-SI47-1059-E), Chapter 1, Section 1.2 "External View and Terminal Blocks."

[8] *OH2* Alarm issued by an external device

Problem External alarm was inputted (THR).
(in case external alarm (THR) is assigned to one of digital input terminals [X1] through [X5], [FWD], or [REV])

Possible Causes	What to Check and Suggested Measures
(1) An alarm function of the external equipment was activated.	Inspect external equipment operation. → Remove the cause of the alarm that occurred.
(2) Connection has been performed incorrectly.	Check if the wire for the external alarm signal is correctly connected to the terminal to which the "Alarm from external equipment" has been assigned (Any of E01, E02, E03, E04, E05, E98, and E99 is set to "9"). → Connect the wire for the alarm signal correctly.
(3) Incorrect settings.	Check if the "Alarm from external equipment" has not been assigned to an unassigned terminal assigned (E01, E02, E03, E04, E05, E98, or E99). → Correct the assignment.
	Check whether the assignment (normal/negative logic) of the external signal agrees with that of thermal command (THR) set by E01, E02, E03, E04, E05, E98, and E99. → Ensure that the polarity matches.

[9] *OH3* Inside of the inverter overheat

Problem The temperature inside the inverter exceeded the allowable limit.

Possible Causes	What to Check and Suggested Measures
(1) The ambient temperature exceeded the allowable limit specified for the inverter.	Measure the ambient temperature. → Lower the ambient temperature by improving the ventilation.

[10] *OH4* Motor protection (PTC thermistor)

Problem Temperature of the motor rose abnormally.

Possible Causes	What to Check and Suggested Measures
(1) Temperature around the motor exceeded that of motor specifications.	Measure the temperature around the motor. → Lower the temperature.
(2) Cooling system for the motor malfunctioned.	Check if the cooling system of the motor is operating normally. → Repair or replace the cooling system of the motor.
(3) Load was too heavy.	Measure the output current. → Lighten the load (e.g., lighten the load before overload occurs using the overload early warning (E34) function) (In winter, the load tends to increase.). → Lower the temperature around the motor. → Increase the motor sound (carrier frequency) (F26).

Possible Causes	What to Check and Suggested Measures
(4) The set activation level (H27) of the PTC thermistor for motor overheat protection was inadequate.	Check the thermistor specifications and recalculate the detection voltage. → Reconsider the data of function code H27.
(5) A PTC thermistor and pull-up resistor were connected incorrectly or the resistance was inadequate.	Check the connection and the resistance of the pull-up resistor. → Correct the connections and replace the resistor with one with an appropriate resistance.
(6) The value set for the torque boost (F09) was too high.	Check the data of function code F09 and readjust the data so that the motor does not stall even if you set the data to a lower value. → Readjust the data of the function code F09.
(7) The V/f pattern did not match the motor.	Check if the base frequency (F04) and rated voltage at base frequency (F05) match the values on the nameplate on the motor. → Match the function code data to the values on the nameplate of the motor.
(8) Wrong settings	Although no PTC thermistor is used, the V2/PTC switch is turned to PTC, which means that the thermistor input is active on the PTC (H26). → Set H26 (PTC thermistor Input) to "0" (inactive).

[11] *FUS* Fuse blown (90 kW or above)

Problem The fuse inside the inverter blew.

Possible Causes	What to Check and Suggested Measures
(1) The fuse blew because of a short-circuiting inside the inverter.	Check whether there has been any excess surge or noise coming from outside. → Take measures against surges and noise. → Have the inverter repaired.

[12] *PbF* Charger circuit fault
(45 kW or above (200 V Series), 55 kW or above (400 V Series))

Problem The magnetic contactor for short-circuiting the resistor for charging failed to work.

Possible Causes	What to Check and Suggested Measures
(1) Control power was not supplied to the magnetic contactor intended for short-circuiting the charging resistor.	Check whether, in normal connection of the main circuit (not connection via the DC link bus), the connector (CN) on the power supply printed circuit board is not inserted to [NC]. → Insert the connector to [FAN]. Check whether you have quickly turned the circuit breaker ON and OFF to confirm safety after cabling/wiring. → Wait until the DC link bus voltage has dropped to a sufficiently low level and then reset the current alarm, and turn ON the power again. (Do not turn the circuit breaker ON and OFF quickly.) (Turning ON the circuit breaker supplies power to the control circuit to the operation level (lighting LEDs on the keypad) in a short period. Immediately turning it OFF even retains the control circuit power for a time, while it shuts down the power to the magnetic contactor intended for short-circuiting the charging resistor since the contactor is directly powered from the main power. Under such conditions, the control circuit can issue a turn-on command to the magnetic contactor, but the contactor not powered can produce nothing. This state is regarded as abnormal, causing an alarm.)

[13] *OL* / Electronic thermal overload relay

Problem Electronic thermal function for motor overload detection was activated.

Possible Causes	What to Check and Suggested Measures
(1) The characteristics of electronic thermal did not match those of the motor overload.	Check the motor characteristics. → Reconsider the data of function codes P99, F10 and F12. → Use an external thermal relay.
(2) Activation level for the electronic thermal relay was inadequate.	Check the continuous allowable current of the motor. → Reconsider and change the data of function code F11.
(3) The acceleration/ deceleration time was too short.	Check that the motor generates enough torque for acceleration/ deceleration. This torque is calculated from the moment of inertia for the load and the acceleration/ deceleration time. → Increase the acceleration/ deceleration time (F07 and F08).
(4) Load was too heavy.	Measure the output current. → Lighten the load (e.g., lighten the load before overload occurs using the overload early warning (E34)). (In winter, the load tends to increase.)



[14] *OLU* Overload

Problem Temperature inside inverter rose abnormally.

Possible Causes	What to Check and Suggested Measures
(1) Temperature around the inverter exceeded that of inverter specifications.	Measure the temperature around the inverter. → Lower the temperature (e.g., ventilate the enclosure well).
(2) The torque boost setting (F09) was too high.	Check the setting of F09 (torque boost) and make sure that lowering it would not cause the motor to stall. → Adjust the setting of F09.
(3) The acceleration/ deceleration time was too short.	Recalculate the required acceleration/deceleration torque and time from the moment of inertia for the load and the deceleration time. → Increase the acceleration/deceleration time (F07 and F08).
(4) Load was too heavy.	Measure the output current. → Lighten the load (e.g., lighten the load before overload occurs using the overload early warning (E34)). (In winter, the load tends to increase.) → Decrease the motor sound (carrier frequency) (F26). → Enable overload protection control (H70).
(5) Air vent is blocked.	Check if there is sufficient clearance around the inverter. → Increase the clearance. Check if the heat sink is not clogged. → Clean the heat sink.
(6) The service life of the cooling fan has expired or the cooling fan malfunctioned.	Check the cumulative running time of cooling fan. Refer to the Instruction Manual (INR-SI47-1059-E), Chapter 3, Section 3.4.6 "Reading maintenance information – "Maintenance Information"." → Replace the cooling fan. Visually check that the cooling fan rotates normally. → Replace the cooling fan.
(7) The wires to the motor are too long and caused a large amount of current to leak from them.	Measure the leakage current. → Insert an output circuit filter (OFL).

[15] E_r / Memory error

Problem Error occurred in writing the data to the memory in the inverter.

Possible Causes	What to Check and Suggested Measures
(1) While the inverter was writing data (especially initializing data or copying data), power supply was turned OFF and the voltage for the control circuit dropped.	Check if pressing the  key resets the alarm after the function code data are initialized by setting the data of H03 to 1. → Return the initialized function code data to their previous settings, then restart the operation.
(2) A high intensity noise was given to the inverter while data (especially initializing data) was being written.	Check if appropriate noise control measures have been implemented (e.g., correct grounding and routing of control and main circuit wires). Also, perform the same check as described in (1) above. → Improve noise control. Alternatively, return the initialized function code data to their previous settings, then restart the operation.
(3) The control circuit failed.	Initialize the function code data by setting H03 to 1, then reset the alarm by pressing the  key and check that the alarm goes on. → This problem was caused by a problem of the printed circuit board (PCB) (on which the CPU is mounted). Contact your Fuji Electric representative.

[16] E_r Keypad communications error

Problem A communications error occurred between the remote keypad and the inverter.

Possible Causes	What to Check and Suggested Measures
(1) Break in the communications cable or poor contact.	Check continuity of the cable, contacts and connections. → Re-insert the connector firmly. → Replace the cable.
(2) A high intensity noise was given to the inverter.	Check if appropriate noise control measures have been implemented (e.g., correct grounding and routing of control and main circuit wires). → Improve noise control. For details, refer to "Appendix A."
(3) The keypad malfunctioned.	Check that alarm E_r does not occur if you connect another keypad to the inverter. → Replace the keypad.

[17] E_r CPU error

Problem A CPU error (e.g. erratic CPU operation) occurred.

Possible Causes	What to Check and Suggested Measures
(1) A high intensity noise was given to the inverter.	Check if appropriate noise control measures have been implemented (e.g. correct grounding and routing of control and main circuit wires and communications cable). → Improve noise control.

[18] Er-4 Option card communications error

Problem A communications error occurred between the option card and the inverter.

Possible Causes	What to Check and Suggested Measures
(1) There was a problem with the connection between the bus option card and the inverter.	Check whether the connector on the bus option card is properly mating with the connector of the inverter. → Reload the bus option card into the inverter.
(2) There was a high intensity noise from outside.	Check whether appropriate noise control measures have been implemented (e.g. correct grounding and routing of control and main circuit wires and communications cable). → Reinforce noise control measures.

[19] Er-5 Option card error

An error detected by the option card. Refer to the instruction manual of the option card for details.

[20] Er-6 Incorrect operation error

Problem You incorrectly operated the inverter.



Possible Causes	What to Check and Suggested Measures
(1) The  key was pressed when H96 = 1 or 3.	Although a Run command had been inputted from the input terminal or through the communications port, the inverter was forced to decelerate to stop. → If this was not intended, check the setting of H96.
(2) The start check function was activated when H96 = 2 or 3.	With a Run command being inputted, any of the following operations has been performed: - Turning the power ON - Releasing the alarm - Switching the enable communications link (LE) operation → Review the running sequence to avoid input of a Run command when this error occurs. If this was not intended, check the setting of H96. (To reset the alarm, turn the Run command OFF.)
(3) The forced stop digital input (STOP) was turned ON.	Turning ON the forced stop digital input (STOP) decelerated the inverter to stop according to the specified deceleration period (H96). → If this was not intended, check the settings of E01 through E05 on terminals [X1] through [X5].

[21] <i>E-7</i> Tuning error	
Problem Auto-tuning failed.	
Possible Causes	What to Check and Suggested Measures
(1) A phase was missing (There was a phase loss) in the connection between the inverter and the motor.	→ Properly connect the motor to the inverter.
(2) V/f or the rated current of the motor was not properly set.	Check whether the data of function codes F04, F05, H50, H51, P02, and P03 agrees with the specifications of the motor.
(3) The connection between the inverter and the motor was too long.	Check whether the connection length between the inverter and the motor is not exceeding 50m. → Review, and if necessary, change the layout of the inverter and the motor to shorten the connection wire. Alternatively, minimize the connection wire length without changing the layout. → Disable both auto-tuning and auto-torque (set F37 to "1").
(4) The rated capacity of the motor was significantly different from that of the inverter.	Check whether the rated capacity of the motor is smaller than that of the inverter by three or more orders of class or larger by two or more orders of class. → Check whether it is possible to replace the inverter with one with an appropriate capacity. → Manually specify the values for the motor parameters P06, P07, and P08. → Disable both auto-tuning and auto-torque boost (set F37 to "1").
(5) The motor was a special type such as a high-speed motor.	→ Disable both auto-tuning and auto-torque boost (set F37 to "1").
 For details of tuning errors, refer to "Errors during Tuning" in the Instruction Manual (INR-SI47-1059-E), Chapter 4, Section 4.1.3 "Preparation before running the motor for a test – Setting function code data."	
[22] <i>E-8</i> RS-485 communications error	
Problem A communications error occurred during RS-485 communications.	
Possible Causes	What to Check and Suggested Measures
(1) Conditions for communications differ between the inverter and host equipment.	Compare the settings of the y codes (y01 to y10) with those of the host equipment. → Correct any settings that differ.
(2) Even though no response error detection time (y08) has been set, communications is not performed within the specified cycle.	Check the host equipment. → Change the settings of host equipment software, or make the no response error detection time be ignored (y08=0).
(3) Host equipment (e.g., PLCs and personal computers) did not operate due to incorrect settings and/or defective software/hardware.	Check the host equipment. → Remove the cause of the equipment error.
(4) Relay converters (e.g., RS-485 relay converter) did not operate due to incorrect connections and settings, or defective hardware.	Check the RS-485 relay converter (e.g., check for poor contact). → Change the various RS-485 converter settings, reconnect the wires, or replace hardware (such as recommended devices) as appropriate.
(5) Broken communications cable or poor contact.	Check continuity of the cable, contacts and connections. → Replace the cable.

Possible Causes	What to Check and Suggested Measures
(6) A high intensity noise was given to the inverter.	<p>Check if appropriate noise control measures have been implemented (e.g., correct grounding and routing of control and main circuit wires).</p> <ul style="list-style-type: none"> ➔ Improve noise control. ➔ Improve noise reduction measures on the host side. ➔ Replace the RS-485 relay converter with a recommended insulated converter.

[23] E_rF Data saving error during undervoltage

Problem The inverter was unable to save data such as the frequency commands and PID process command set through the keypad when the power was switched off.

Possible Causes	What to Check and Suggested Measures
(1) The control circuit voltage dropped suddenly while data was being saved when the power was turned OFF, because the DC link bus was rapidly discharged.	<p>Check how long it takes for the DC link bus voltage to drop to the preset voltage when power is turned OFF.</p> <ul style="list-style-type: none"> ➔ Remove whatever is causing the rapid discharge of the DC link bus electricity. After pressing the  key and releasing the alarm, set, using a remote keypad, the data of the relevant function codes (such as the frequency commands and PID process command) back to the original values and then restart the operation.
(2) A high intensity noise affected the operation of the inverter while data was being saved when the power was turned OFF.	<p>Check if appropriate noise control measures have been implemented (e.g., correct grounding and routing of control and main circuit wires).</p> <ul style="list-style-type: none"> ➔ Improve noise control. After pressing the  key and releasing the alarm, set, using a remote keypad, the data of the relevant function codes (such as the frequency commands and PID process command) back to the original values and then restart the operation.
(3) The control circuit failed.	<p>Check if E_rF occurs each time power is switched on.</p> <ul style="list-style-type: none"> ➔ This problem was caused by a problem of the printed circuit board (PCB) (on which the CPU is mounted). Contact your Fuji Electric representative.

[24] E_rP RS-485 communications error (Option card)

Problem A communications error occurred during RS-485 communications (Option card).

Possible Causes	What to Check and Suggested Measures
(1) Conditions for communications differ between the inverter and host equipment.	<p>Compare the settings of the y codes (y01 to y10) with those of the host equipment.</p> <ul style="list-style-type: none"> ➔ Correct any settings that differ.
(2) Even though no response error detection time (y18) has been set, communications did not occur cyclically.	<p>Check the host equipment.</p> <ul style="list-style-type: none"> ➔ Change the settings of host equipment software, or make the no response error detection time invalid (y18=0).
(3) Host equipment (e.g., PLCs and personal computers) did not operate due to incorrect settings and/or defective software/hardware.	<p>Check the host equipment.</p> <ul style="list-style-type: none"> ➔ Remove the cause of the equipment error.
(4) Relay converters (e.g., RS-485 relay converter) did not operate due to incorrect connections and settings, and defective hardware.	<p>Check the RS-485 relay converter (e.g., check for poor contact).</p> <ul style="list-style-type: none"> ➔ Change the various RS-485 converter settings, reconnect the wires, or replace hardware (such as recommended devices) as appropriate.

Possible Causes	What to Check and Suggested Measures
(5) Broken communications cable or poor contact.	Check continuity of the cable, contacts and connections. → Replace the cable.
(6) A high intensity noise was given to the inverter.	Check if appropriate noise control measures have been implemented (e.g., correct grounding and routing of control and main circuit wires). → Improve noise control. → Improve noise reduction measures on the host side. → Replace the RS-485 relay converter with a recommended insulated converter.
(7) The RS-485 communications card malfunctioned.	→ Replace the card.

[25] E-H LSI error (Power PCB) (45 kW or above (200 V series); 55 kW or above (400 V series))



Problem An error occurred in the LSI on the power printed circuit board (power PCB).

Possible Causes	What to Check and Suggested Measures
(1) The capacity is not set properly on the control printed circuit board.	The inverter capacity needs to be modified again. → Contact your Fuji Electric representative.
(2) The contents of the memory on the power supply printed circuit board are corrupted.	The power supply printed circuit board needs to be replaced. → Contact your Fuji Electric representative.
(3) Connection problem between the control printed circuit board and the power supply printed circuit board	Either the control printed circuit board or the power supply printed circuit board needs to be replaced. → Contact your Fuji Electric representative.

10.4 If an Abnormal Pattern Appears on the LED Monitor while No Alarm Code is Displayed

[1] ---- (center bar) appears

Problem A center bar (----) has appeared on the LCD monitor.

Possible Causes	What to Check and Suggested Measures
(1) When PID control had been disabled (J01=0), you changed E43 (display selection) to 10 or 12. You disabled PID control (J01=0) when the LED monitor had been set to display the PID final command value or PID feedback value by pressing the  key.	Make sure that when you wish to view other monitor items, E43 is not set to "10: PID process command (final)" or "12: PID feedback value." → Set E43 to a value other than "10" or "12." Make sure that when you wish to view a PID process command or a PID feedback value, PID control is still in effect or J01 is not set to 0. → Set J01 to "1: Enable (normal operation)" or "2: Enable (inverse operation)."
(2) Connection to the keypad was in poor connection.	Prior to proceed, check that pressing the  key does not take effect for the LED display. Check connectivity of the extension cable for the keypad used in remote operation. → Replace the cable.

[2] _ _ _ _ (under bar) appears

Problem An under bar (_ _ _ _) appeared on the LED monitor when you pressed the  key or entered a run forward command (FWD) or a run reverse command (REV). The motor did not start.

Possible Causes	What to Check and Suggested Measures
(1) The voltage of the DC link bus was low.	Select  under Menu #5 "Maintenance Information" in Programming mode on the keypad, and check the voltage of the DC link bus, which should be: 200 VDC or below for 3-phase 200V, and 400 VDC or below for 3-phase 400V. → Connect the inverter to a power supply that meets its input specifications.
(2) The main power is not ON, while the auxiliary input power to the control circuit is supplied.	Check that the main power is turned ON. → If it is not ON, turn it ON.

[3] [] appears

Problem Parentheses ([]) has appeared on the screen while the keypad displaying the Drive Monitor.

Possible Causes	What to Check and Suggested Measures
(1) The data to be displayed could not fit the LED monitor (e.g. overflow).	Check that the product of the output frequency and the display coefficient (E50) does not exceed 9999. → Adjust the setting of E50.

Appendices

Contents

App.A	Advantageous Use of Inverters (Notes on electrical noise).....	A-1
A.1	Effect of inverters on other devices.....	A-1
A.2	Noise.....	A-2
A.3	Noise prevention.....	A-4
App.B	Japanese Guideline for Suppressing Harmonics by Customers Receiving High Voltage or Special High Voltage.....	A-12
B.1	Application to general-purpose inverters.....	A-12
B.2	Compliance to the harmonic suppression for customers receiving high voltage or special high voltage.....	A-13
App.C	Effect on Insulation of General-purpose Motors Driven with 400 V Class Inverters.....	A-17
C.1	Generating mechanism of surge voltages.....	A-17
C.2	Effect of surge voltages.....	A-18
C.3	Countermeasures against surge voltages.....	A-18
C.4	Regarding existing equipment.....	A-19
App.D	Inverter Generating Loss.....	A-20
App.E	Conversion from SI Units.....	A-21
App.F	Allowable Current of Insulated Wires.....	A-23

App.A Advantageous Use of Inverters (Notes on electrical noise)

- Disclaimer: This document provides you with a summary of the Technical Document of the Japan Electrical Manufacturers' Association (JEMA) (April 1994). It is intended to apply to the domestic market only. It is only for reference for the foreign market. -

A.1 Effect of inverters on other devices

Inverters have been and are rapidly expanding its application fields. This paper describes the effect that inverters have on electronic devices already installed or on devices installed in the same system as inverters, as well as introducing noise prevention measures. (Refer to Section A.3 [3], "Noise prevention examples" for details.)

[1] Effect on AM radios

<u>Phenomenon</u>	If an inverter operates, an AM radio set near the inverter may pick up noise radiated from the inverter. (An inverter has almost no effect on an FM radio or television set.)
<u>Probable cause</u>	Radios may receive noise radiated from the inverter.
<u>Measures</u>	Inserting a noise filter on the power source (primary) side of the inverter is effective.

[2] Effect on telephones

<u>Phenomenon</u>	If an inverter operates, nearby telephones may pick up noise radiated from the inverter in conversation so that it may be difficult to hear.
<u>Probable cause</u>	A high-frequency leakage current radiated from the inverter and motors enters shielded telephone cables, causing noise.
<u>Measures</u>	It is effective to commonly connect the grounding terminals of the motors and return the common grounding line to the grounding terminal of the inverter.

[3] Effect on proximity switches

<u>Phenomenon</u>	If an inverter operates, proximity switches (capacitance-type) may malfunction.
<u>Probable cause</u>	The capacitance-type proximity switches may provide inferior noise immunity.
<u>Measures</u>	It is effective to connect a filter to the input terminals of the inverter or change the power supply treatment of the proximity switches. These switches can be replaced with superior noise immunity types such as magnetic type ones.

[4] Effect on pressure sensors

<u>Phenomenon</u>	If an inverter operates, pressure sensors may malfunction.
<u>Probable cause</u>	Noise may penetrate through a grounding wire into the signal line.
<u>Measures</u>	It is effective to install a noise filter on the power source (primary) side of the inverter or to change the wiring.

[5] Effect on position detectors (pulse generators PGs or pulse encoders)

<u>Phenomenon</u>	If an inverter operates, pulse encoders may produce erroneous pulses that shift the stop position of a machine.
<u>Probable cause</u>	Erroneous pulses are liable to occur when the signal lines of the PG and power lines are bundled together.
<u>Measure</u>	The influence of induction noise and radiation noise can be reduced by separating the PG signal lines and power lines. Providing noise filters at the input and output terminals will be also an effective measure.

A.2 Noise

This section gives a summary of noises generated in inverters and their effects on devices subject to noise.

[1] Inverter noise

Figure A.1 shows an outline of the inverter configuration. The inverter converts AC to DC (rectification) in a converter unit, and converts DC to AC (inversion) with 3-phase variable voltage and variable frequency. The conversion (inversion) is performed by PWM implemented by switching six transistors (IGBT: Insulated Gate Bipolar Transistor, etc), and is used for variable speed motor control.

Switching noise is generated by high-speed on/off switching of the six transistors. Noise current (i) is emitted and at each high-speed on/off switching, the noise current flows through stray capacitance (C) of the inverter, cable and motor to the ground. The amount of the noise current is expressed as follows:

$$i = C \cdot dv/dt$$

It is related to the stray capacitance (C) and dv/dt (switching speed of the transistors). Further, this noise current is related to the carrier frequency since the noise current flows each time the transistors are switched on or off.

In addition to the main inverter part, the DC-to-DC switching power regulator (DC-DC converter), which is the power source for the control electronics of the inverter, may be a noise source in the same principles as stated above. Refer to Figure A.1 below.

The frequency band of this noise is less than approximately 30 to 40 MHz. Therefore, the noise will affect devices such as AM radio sets using low frequency band, but will not virtually affect FM radio sets and television sets using higher frequency than this frequency band.

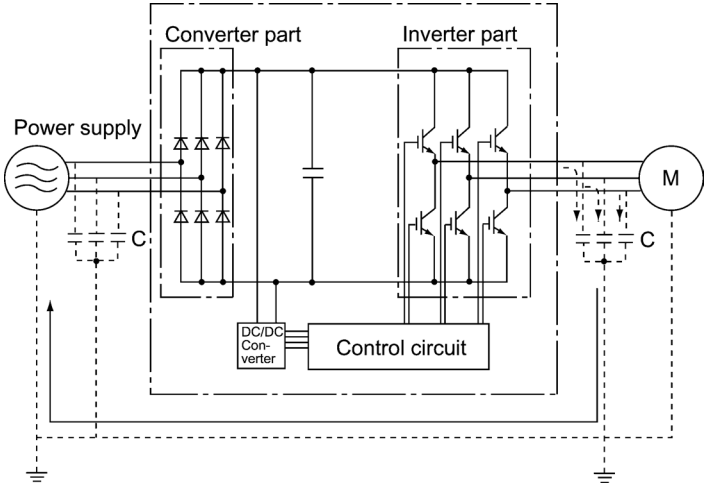

Figure A.1 Outline of Inverter Configuration

[2] Types of noise

Noise generated in an inverter is propagated through the main circuit wiring to the power source (primary) and output (secondary) sides so as to affect a wide range of applications from the power supply transformer to the motor. The various propagation routes are shown in Figure A.2. According to those routes, noises are roughly classified into three types--conduction noise, induction noise, and radiation noise.

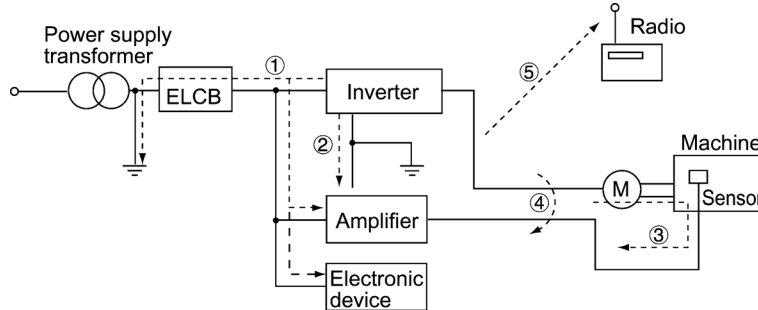

Figure A.2 Noise Propagation Routes

(1) Conduction noise

Noise generated in an inverter may propagate through the conductor and power supply so as to affect peripheral devices of the inverter (Figure A.3). This noise is called "conduction noise." Some conduction noises will propagate through the main circuit ①. If the ground wires are connected to a common ground, conduction noise will propagate through route ②. As shown in route ③, some conduction noises will propagate through signal lines or shielded wires.

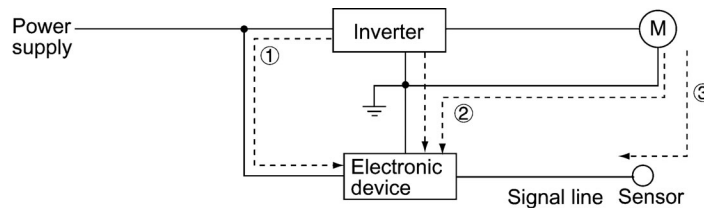

Figure A.3 Conduction Noise

(2) Induction noise

When wires or signal lines of peripheral devices are brought close to the wires on the input and output sides of the inverter through which noise current is flowing, noise will be induced into those wires and signal lines of the devices by electromagnetic induction (Figure A.4) or electrostatic induction (Figure A.5). This is called "induction noise" ④.

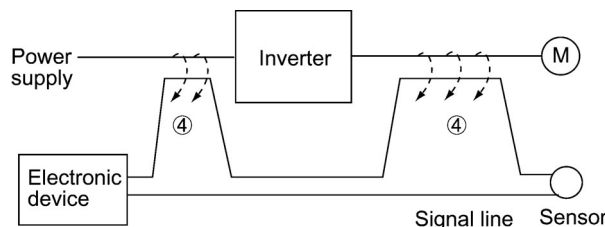

Figure A.4 Electromagnetic Induction Noise

App.

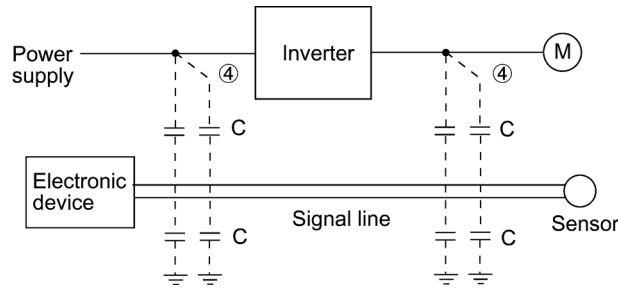

Figure A.5 Electrostatic Induction Noise

(3) Radiation noise

Noise generated in an inverter may be radiated through the air from wires (that act as antennas) at the power source (primary) and output (secondary) sides of the inverter. This noise is called "radiation noise" ⑤ as shown below. Not only wires but motor frames or power control panels containing inverters may also act as antennas.

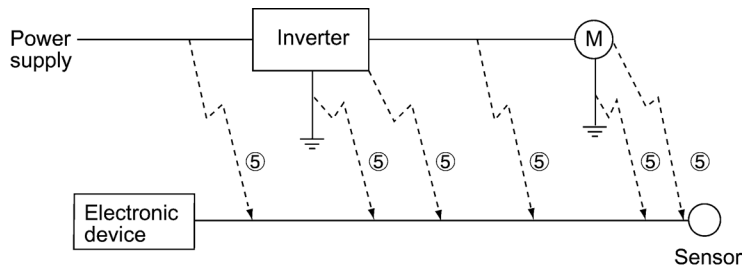

Figure A.6 Radiation Noise

A.3 Noise prevention

The more noise prevention is strengthened, the more effective. However, with the use of appropriate measures, noise problems may be resolved easily. It is necessary to implement economical noise prevention according to the noise level and the equipment conditions.

[1] Noise prevention prior to installation

Before inserting an inverter in your power control panel or installing an inverter panel, you need to consider noise prevention. Once noise problems occur, it will cost additional materials and time for solving them.

Noise prevention prior to installation includes:

- 1) Separating the wiring of main circuits and control circuits
- 2) Putting main circuit wiring into a metal pipe (conduit pipe)
- 3) Using shielded wires or twist shielded wires for control circuits.
- 4) Implementing appropriate grounding work and grounding wiring.

These noise prevention measures can avoid most noise problems.

[2] Implementation of noise prevention measures

There are two types of noise prevention measures--one for noise propagation routes and the other for noise receiving sides (that are affected by noise).

The basic measures for lessening the effect of noise at the receiving side include:

Separating the main circuit wiring from the control circuit wiring, avoiding noise effect.

The basic measures for lessening the effect of noise at the generating side include:

- 1) Inserting a noise filter that reduces the noise level.
- 2) Applying a metal conduit pipe or metal panel that will confine noise, and
- 3) Applying an insulated transformer for the power supply that cuts off the noise propagation route.

Table A.1 lists the noise prevention measures, their goals, and propagation routes.

Table A.1 Noise Prevention Measures

Noise prevention method		Goal of noise prevention measures				Conduction route		
		Make it more difficult to receive noise	Cutoff noise conduction	Confine noise	Reduce noise level	Conduction noise	Induction noise	Radiation noise
Wiring and installation	Separate main circuit from control circuit	Y					Y	
	Minimize wiring distance	Y			Y		Y	Y
	Avoid parallel and bundled wiring	Y					Y	
	Use appropriate grounding	Y			Y	Y	Y	
	Use shielded wire and twisted shielded wire	Y					Y	Y
	Use shielded cable in main circuit			Y			Y	Y
	Use metal conduit pipe			Y			Y	Y
Power control panel	Appropriate arrangement of devices in the panel	Y					Y	Y
	Metal panel			Y			Y	Y
Anti-noise device	Line filter	Y			Y	Y		Y
	Insulation transformer		Y			Y		Y
Measures at noise receiving sides	Use a passive capacitor for control circuit	Y					Y	Y
	Use ferrite core for control circuit	Y			Y		Y	Y
	Line filter	Y		Y		Y		
Others	Separate power supply systems		Y			Y		
	Lower the carrier frequency				Y*	Y	Y	Y

Y: Effective, Y*: Effective conditionally, Blank: Not effective

App.

What follows is noise prevention measures for the inverter drive configuration.

(1) Wiring and grounding

As shown in Figure A.7, separate the main circuit wiring from control circuit wiring as far as possible regardless of being located inside or outside the system panel containing an inverter. Use shielded wires and twisted shielded wires that will block out extraneous noises, and minimize the wiring distance. Also avoid bundled wiring of the main circuit and control circuit or parallel wiring.

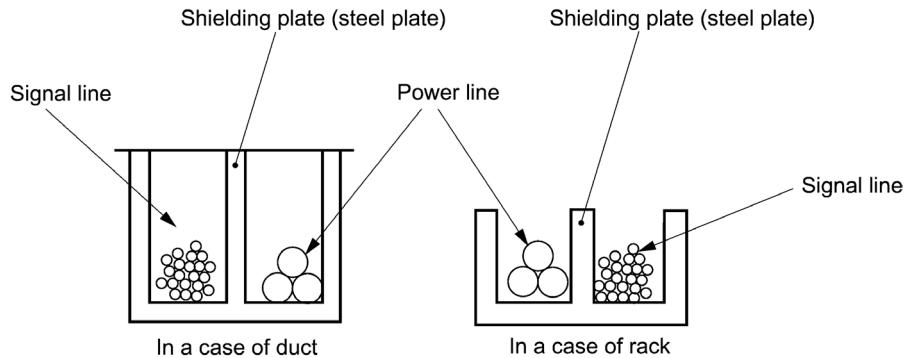

Figure A.7 Separate Wiring

For the main circuit wiring, use a metal conduit pipe and connect its wires to the ground to prevent noise propagation (refer to Figure A.8).

The shield (braided wire) of a shielded wire should be securely connected to the base (common) side of the signal line at only one point to avoid the loop formation resulting from a multi-point connection (refer to Figure A.9).

The grounding is effective not only to reduce the risk of electrical shocks due to leakage current, but also to block noise penetration and radiation. Corresponding to the main circuit voltage, the grounding work should be Class D grounding work (300 VAC or less, grounding resistance of 100Ω or less) and Class C grounding work (300 to 600 VAC, grounding resistance of 10Ω or less). Each ground wire is to be provided with its own ground or separately wired to a grounding point.

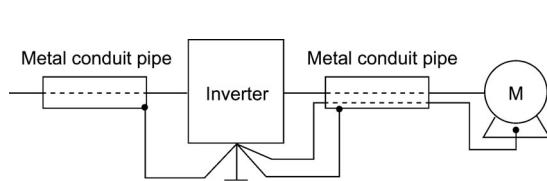

Figure A.8 Grounding of Metal Conduit Pipe

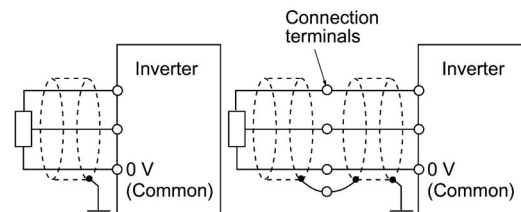

Figure A.9 Treatment of Braided Wire of Shielded Wire

(2) Power control panel

A power control panel containing an inverter is generally made of metal, which can shield noise radiated from the inverter itself.

When installing other electronic devices such as a programmable logic controller in the same panel, be careful with the layout of each device. If necessary, arrange shield plates between the inverter and peripheral devices.

(3) Anti-noise devices

To reduce the noise propagated through the electrical circuits and the noise radiated from the main circuit wiring to the air, a line filter and power supply transformer should be used (refer to Figure A.10).

Line filters are available in these types--the simplified type such as a capacitive filter to be connected in parallel to the power supply line and an inductive filter to be connected in series to the power supply line and the orthodox type such as an LC filter to meet radio noise regulations. Use them according to the targeted effect for reducing noise.

Power supply transformers include popular isolation transformers, shielded transformers, and noise-cutting transformers. These transformers have different effectiveness in blocking noise propagation.

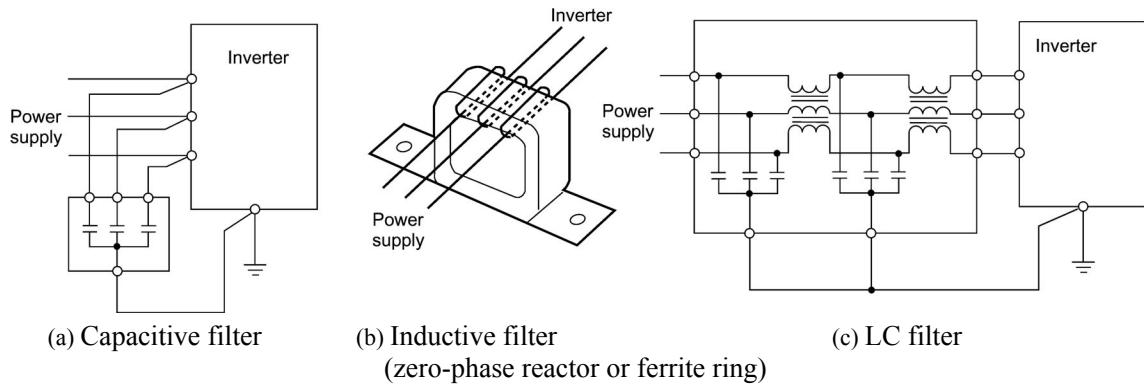

Figure A.10 Various Filters and their Connection

(4) Noise prevention measures at the receiving side

It is important to strengthen the noise immunity of those electronic devices installed in the same panel as the inverter or located near an inverter. Line filters and shielded or twisted shielded wires are used to block the penetration of noise in the signal lines of these devices. The following treatments are also implemented.

- 1) Lower the circuit impedance by connecting capacitors or resistors to the input and output terminals of the signal circuit in parallel.
- 2) Increase the circuit impedance for noise by inserting choke coils in series in the signal circuit or passing signal lines through ferrite core beads. It is also effective to widen the signal base lines (0 V line) or grounding lines.

(5) Other

The level of generating/propagating noise will change with the carrier frequency of the inverter. The higher the carrier frequency, the higher the noise level.

In an inverter that can change the carrier frequency, lowering the carrier frequency can reduce the generation of electrical noise and result in a good balance with the audible noise of the running motor.

[3] Noise prevention examples

Table A.2 lists examples of the measures to prevent noise generated by a running inverter.

Table A.2 Examples of Noise Prevention Measures

No.	Target device	Phenomena	Noise prevention measures	
				Notes
1	AM radio set	<p>When operating an inverter, noise enters into an AM radio broadcast band (500 to 1500 kHz).</p>  <p><Possible cause> The AM radio set may receive noise radiated from wires at the power source (primary) and output (secondary) sides of the inverter.</p>	<ol style="list-style-type: none"> 1) Install an LC filter at the power source side of the inverter. (In some cases, a capacitive filter may be used as a simple method.) 2) Install a metal conduit wiring between the motor and inverter. Or use shielded wiring.  <p>Note: Minimize the distance between the LC filter and inverter as much as possible (within 1m).</p>	<ol style="list-style-type: none"> 1) The radiation noise of the wiring can be reduced. 2) The conduction noise to the power source side can be reduced. <p>Note: Sufficient improvement may not be expected in narrow regions such as between mountains.</p>
2	AM radio set	<p>When operating an inverter, noise enters into an AM radio broadcast band (500 to 1500 kHz).</p>  <p><Possible cause> The AM radio set may receive noise radiated from the power line at the power source (primary) side of the inverter.</p>	<ol style="list-style-type: none"> 1) Install inductive filters at the power source (primary) and output (secondary) sides of the inverter.  <p>The number of turns of the zero-phase reactor (or ferrite ring) should be as large as possible. In addition, wiring between the inverter and the zero-phase reactor (or ferrite ring) should be as short as possible. (within 1m)</p> <ol style="list-style-type: none"> 2) When further improvement is necessary, install LC filters. 	<ol style="list-style-type: none"> 1) The radiation noise of the wiring can be reduced.

Table A.2 Continued

No.	Target device	Phenomena	Noise prevention measures	
				Notes
3	Telephone (in a common private residence at a distance of 40 m)	<p>When driving a ventilation fan with an inverter, noise enters a private telephone in a residence at a distance of 40 m.</p>  <p><Possible cause> A high-frequency leakage current emitted from the inverter or motor onto the commercial power lines interferes with a public telephone network service hub near the pole transformer, through the transformer's grounding line. In this case, the leakage current flowing on the grounding line may crosstalk in the hub through its grounding line and will be propagated to the telephone by electrostatic induction.</p>	<p>1) Connect the ground terminals of the motors in a common connection with the inverter to return the high frequency components to the inverter panel, and insert a 1 μF capacitor between the input terminal of the inverter and ground. Refer to the note at right for details.</p> 	<p>1) The effect of the inductive filter and LC filter may not be expected because of its incapability of eliminating audio frequency.</p> <p>2) In the case of a V-connection power supply transformer in a 200V system, it is necessary to connect capacitors as shown in the following figure, because of different potentials to ground.</p> 
4	Photoelectric relay	<p>A photoelectric relay malfunctioned when the inverter runs the motor. [The inverter and motor are installed in the same place (such as for overhead hoist gear)]</p>  <p><Possible cause> It is considered that induction noise entered the photoelectric relay since the inverter's input power supply line and the photoelectric relay's wiring are routed in parallel each other within 25 mm clearance over a distance of 30 to 40 m or longer. Due to restrictions of the installation, these lines cannot be more separated.</p>	<p>1) As a temporary measure, connect a 0.1 μF capacitor between the 0 V terminal of the power supply circuit in the photoelectric relay of the overhead gear and a frame of its panel.</p>  <p>2) As a permanent measure, move the 24 V power supply from the floor to the overhead gear panel, and transfer the photoelectric relay signal to the equipment on the floor with relay contacts in the overhead gear.</p>	<p>1) The wiring is separated by more than 30 cm.</p> <p>2) When separation is impossible, signals can be received and sent with dry contacts etc.</p> <p>3) Never wire weak-current signal lines and power lines closely each other in parallel.</p>

App.

Table A.2 Continued

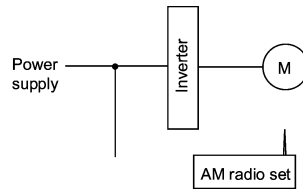
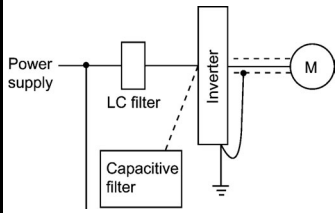
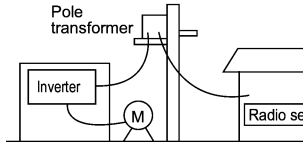
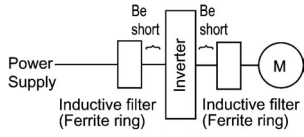
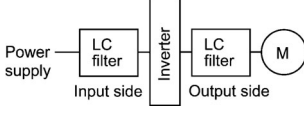
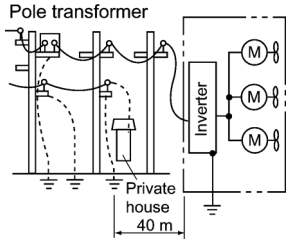
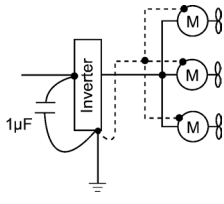
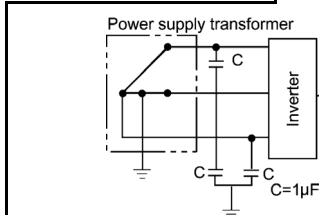
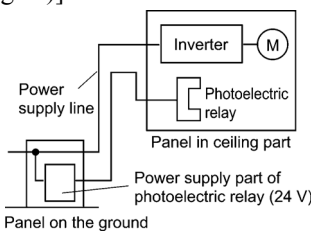
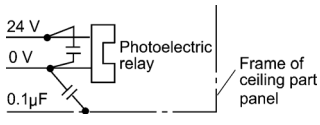
No.	Target device	Phenomena	Noise prevention measures	Notes
5	Photo-electric relay	<p>A photoelectric relay malfunctioned when the inverter was operated.</p>  <p><Possible cause> Although the inverter and photoelectric relay are separated by a sufficient distance but the power supplies share a common connection, it is considered that conduction noise entered through the power supply line into the photoelectric relay.</p>	<p>1) Insert a 0.1 μF capacitor between the output common terminal of the amplifier of the photoelectric relay and the frame.</p> 	<p>1) Taking a weak-current signal circuit malfunctioning into account may help you easily find simple and economical countermeasure.</p>
6	Proximity switch (electrostatic type)	<p>A proximity switch malfunctioned.</p>  <p><Possible cause> It is considered that the capacitance type proximity switch is susceptible to conduction and radiation noise because of its low noise immunity.</p>	<p>1) Install an LC filter at the output (secondary) side of the inverter. 2) Install a capacitive filter at the power source (primary) side of the inverter. 3) Ground the 0 V (common) line of the DC power supply of the proximity switch through a capacitor to the box body of the machine.</p> 	<p>1) Noise generated in the inverter can be reduced. 2) The switch is superseded by a proximity switch of superior noise immunity (such as a magnetic type).</p>

Table A.2 Continued

No.	Target device	Phenomena	Noise prevention measures	Notes
7	Pressure sensor	<p>A pressure sensor malfunctioned.</p>  <p><Possible cause> The pressure sensor may malfunction due to noise that came from the box body through the shielded wire.</p>	<ol style="list-style-type: none"> 1) Install an LC filter on the power source (primary) side of the inverter. 2) Connect the shield of the wire of the pressure sensor to the 0 V line (common) of the pressure sensor, changing the old connection. 	<ol style="list-style-type: none"> 1) The shield sheath of the wire for sensor signal is connected to a common point in the system. 2) Conduction noise from the inverter can be reduced.
8	Position detector (pulse generator : PG)	<p>Erroneous-pulse outputs from a pulse converter caused a shift in the stop position of a crane.</p>  <p><Possible cause> Erroneous pulses may be outputted by induction noise since the power line of the motor and the signal line of the PG are bundled together.</p>	<ol style="list-style-type: none"> 1) Install an LC filter and a capacitive filter at the power source (primary) side of the inverter. 2) Install an LC filter at the output (secondary) side of the inverter. 	<ol style="list-style-type: none"> 1) This is an example of a measure where the power line and signal line cannot be separated. 2) Induction noise and radiation noise at the output side of the inverter can be reduced.
9	Program mable logic controller (PLC)	<p>The PLC program sometimes malfunctions.</p>  <p><Possible cause> Since the power supply system is the same for the PLC and inverter, it is considered that noise enters the PLC through the power supply.</p>	<ol style="list-style-type: none"> 1) Install a capacitive filter and an LC filter on the power source (primary) side of the inverter. 2) Install an LC filter on the output (secondary) side of the inverter. 3) Lower the carrier frequency of the inverter. 	<ol style="list-style-type: none"> 1) Total conduction noise and induction noise in the electric line can be reduced.

App.

App.B Japanese Guideline for Suppressing Harmonics by Customers Receiving High Voltage or Special High Voltage

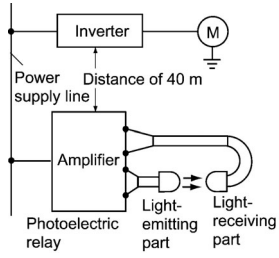
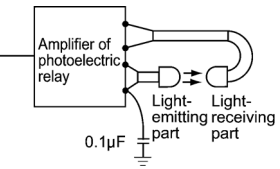
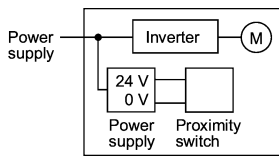
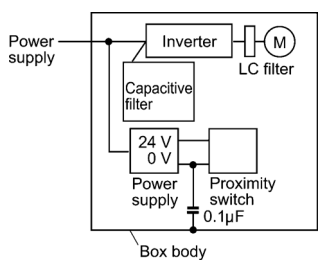
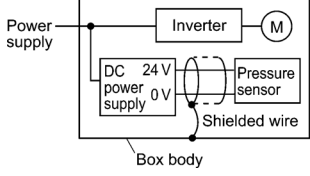
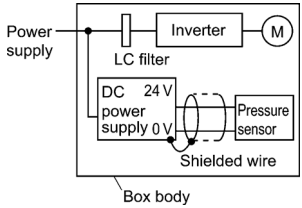
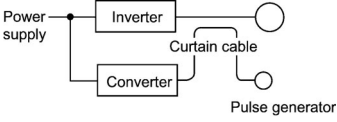
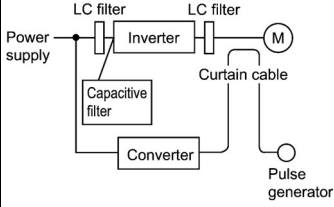
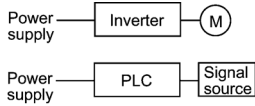
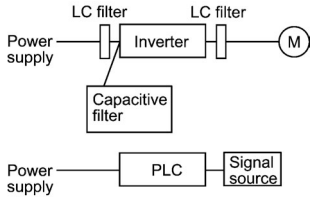
- Disclaimer: This document provides you with a translated summary of the Guideline of the Ministry of International Trade and Industry (September 1994). It is intended to apply to the domestic market only. It is only for reference for the foreign market. -

Agency of Natural Resource and Energy of Japan published the following two guidelines for suppressing harmonic noise in September 1994.

- (1) Guideline for suppressing harmonics in home electric and general-purpose appliances
- (2) Guideline for suppressing harmonics by customers receiving high voltage or special high voltage

Assuming that electronic devices generating high harmonics will be increasing, these guidelines are to establish regulations for preventing high frequency noise interference on devices sharing the power source. These guidelines should be applied to all devices that are used on the commercial power lines and generate harmonic current. This section gives a description limited to general-purpose inverters.

B.1 Application to general-purpose inverters

[1] Guideline for suppressing harmonics in home electric and general-purpose appliances

Our three-phase, 200 V class series inverters of 3.7 kW or less (FRENIC-Eco series) were the products of which were restricted by the "Guideline for Suppressing Harmonics in Home Electric and General-purpose Appliances" (established in September 1994 and revised in October 1999) issued by the Ministry of Economy, Trade and Industry.

The above restriction, however, was lifted when the Guideline was revised in January 2004. Since then, the inverter makers have individually imposed voluntary restrictions on the harmonics of their products.

We, as before, recommend that you connect a reactor (for suppressing harmonics) to your inverter.

[2] Guideline for suppressing harmonics by customers receiving high voltage or special high voltage

Unlike other guidelines, this guideline is not applied to the equipment itself such as a general-purpose inverter, but is applied to each large-scale electric power consumer for total amount of harmonics. The consumer should calculate the harmonics generated from each piece of equipment currently used on the power source transformed and fed from the high or special high voltage source.

(1) Scope of regulation

In principle, the guideline applies to the customers that meet the following two conditions:

- The customer receives high voltage or special high voltage.
- The "equivalent capacity" of the converter load exceeds the standard value for the receiving voltage (50 kVA at a receiving voltage of 6.6 kV).

Appendix B.2 [1] "Calculation of equivalent capacity (Pi)" gives you some supplemental information with regard to estimation for the equivalent capacity of an inverter according to the guideline.

(2) Regulation

The level (calculated value) of the harmonic current that flows from the customer's receiving point out to the system is subjected to the regulation. The regulation value is proportional to the contract demand. The regulation values specified in the guideline are shown in Table B.1.

Appendix B.2 gives you some supplemental information with regard to estimation for the equivalent capacity of the inverter for compliance to "Japanese guideline for suppressing harmonics by customers receiving high voltage or special high voltage."

Table B.1 Upper Limits of Harmonic Outflow Current per kW of Contract Demand (mA/kW)

Receiving voltage	5th	7th	11th	13th	17th	19th	23rd	Over 25th
6.6 kV	3.5	2.5	1.6	1.3	1.0	0.90	0.76	0.70
22 kV	1.8	1.3	0.82	0.69	0.53	0.47	0.39	0.36

(3) When the regulation applied

The guideline has been applied. As the application, the estimation for "Voltage waveform distortion rate" required as the indispensable conditions when entering into the consumer's contract of electric power is already expired.

B.2 Compliance to the harmonic suppression for customers receiving high voltage or special high voltage

When calculating the required matters related to inverters according to the guideline, follow the terms listed below. The following descriptions are based on "Technical document for suppressing harmonics" (JEAG 9702-1995) published by the Japan Electric Association (JEA).

[1] Calculation of equivalent capacity (Pi)

The equivalent capacity (Pi) may be calculated using the equation of (input rated capacity) x (conversion factor). However, catalogs of conventional inverters do not contain input rated capacities, so a description of the input rated capacity is shown below:

(1) "Inverter rated capacity" corresponding to "Pi"

- In the guideline, the conversion factor of a 6-pulse converter is used as reference conversion factor 1. It is, therefore, necessary to express the rated input capacity of inverters in a value including harmonic component current equivalent to conversion factor 1.
- Calculate the input fundamental current I₁ from the kW rating and efficiency of the load motor, as well as the efficiency of the inverter. Then, calculate the input rated capacity as shown below:

$$\text{Input rated capacity} = \sqrt{3} \times (\text{power supply voltage}) \times I_1 \times 1.0228/1000 \text{ (kVA)}$$

where 1.0228 is the 6-pulse converter's value of (effective current)/(fundamental current).

- When a general-purpose motor or inverter motor is used, the appropriate value shown in Table B.2 can be used. Select a value based on the kW rating of the motor used, irrespective of the inverter type.

 The input rated capacity shown above is for the dedicated use in the equation to calculate capacity of the inverters, following the guideline. Note that the capacity cannot be applied to the reference for selection of the equipment or wires to be used in the power source (primary) side.

 For selection of capacity for the peripheral equipment, refer to the catalogs or technical documents issued from their manufacturers.

Table B.2 "Input Rated Capacities" of General-purpose Inverters Determined by the Applicable Motor Ratings

Applicable motor rating (kW)		0.4	0.75	1.5	2.2	3.7 - 4.0	5.5
P _i (kVA)	200V	0.57	0.97	1.95	2.81	4.61	6.77
	400V	0.57	0.97	1.95	2.81	4.61	6.77

(2) Values of "K_i (conversion factor)"

Depending on whether an optional ACR (AC reactor) or DCR (DC reactor) is used, apply the appropriate conversion factor specified in the appendix to the guideline. The values of the conversion factor are listed in Table B.3.

Table B.3 "Conversion Factors K_i" for General-purpose Inverters Determined by Reactors

Circuit category	Circuit type		Conversion factor K _i	Main applications
3	3-phase bridge (w/ reservoir capacitor)	w/o reactor	K31 = 3.4	<ul style="list-style-type: none"> • General-purpose inverters • Elevators • Refrigerators, air conditioning systems • Other general appliances
		w/ reactor (ACR)	K32 = 1.8	
		w/ reactor (DCR)	K33 = 1.8	
		w/ reactors (ACR and DCR)	K34 = 1.4	

Note Some models are equipped with a reactor as a built-in standard accessory.

[2] Calculation of harmonic current

(1) Value of "input fundamental current"

- When you calculate the amount of harmonics according to Table 2 in Appendix of the Guideline, you have to previously know the input fundamental current.
- Apply the appropriate value shown in Table B.4 based on the kW rating of the motor, irrespective of the inverter type or whether a reactor is used.

Note If the input voltage is different, calculate the input fundamental current in inverse proportion to the voltage.

Table B.4 "Input Fundamental Currents" of General-purpose Inverters Determined by the Applicable Motor Ratings

Applicable motor rating (kW)		0.4	0.75	1.5	2.2	3.7 - 4.0	5.5
Input fundamental current (A)	200V	1.62	2.74	5.50	7.92	13.0	19.1
	400V	0.81	1.37	2.75	3.96	6.50	9.55
6.6 kV converted value (mA)		49	83	167	240	394	579

(2) Calculation of harmonic current

Usually, calculate the harmonic current according to the Sub-table 3 "Three phase bridge rectifier with the reservoir capacitor" in Table 2 of the Guideline's Appendix. Table B.5 lists the contents of the sub-table 3.

Table B.5 Generated Harmonic Current (%), 3-phase Bridge Rectifier (w/ reservoir capacitor)

Higher harmonics order	5th	7th	11th	13th	17th	19th	23rd	25th
w/o a reactor	65	41	8.5	7.7	4.3	3.1	2.6	1.8
w/ a reactor (ACR)	38	14.5	7.4	3.4	3.2	1.9	1.7	1.3
w/ a reactor (DCR)	30	13	8.4	5.0	4.7	3.2	3.0	2.2
w/ reactors (ACR and DCR)	28	9.1	7.2	4.1	3.2	2.4	1.6	1.4

- ACR: 3%
- DCR: Accumulated energy equal to 0.08 to 0.15 ms (100% load conversion)
- Reservoir capacitor: Accumulated energy equal to 15 to 30 ms (100% load conversion)
- Load: 100%

Calculate the harmonic current of each order using the following equation:

$$\text{nth harmonic current (A)} = \text{Fundamental current (A)} \times \frac{\text{Generated nth harmonic current (\%)}}{100}$$

(3) Maximum availability factor

- For a load for elevators, which provides intermittent operation, or a load with a sufficient designed motor rating, reduce the current by multiplying the equation by the "maximum availability factor" of the load.
- The "maximum availability factor of an appliance" means the ratio of the capacity of the harmonic generating source in operation at which the availability reaches the maximum, to its total capacity, and the capacity of the generating source in operation is an average for 30 minutes.
- In general, the maximum availability factor is calculated according to this definition, but the standard values shown in Table B.6 are recommended for inverters for building equipment.

Table B.6 Availability Factors of Inverters, etc. for Building Equipment (Standard Values)

Equipment type	Inverter capacity category	Single inverter availability
Air conditioning system	200 kW or less	0.55
	Over 200 kW	0.60
Sanitary pump	————	0.30
Elevator	————	0.25
Refrigerator, freezer	50 kW or less	0.60
UPS (6-pulse)	200 kVA	0.60

Correction coefficient according to contract demand level

Since the total availability factor decreases if the scale of a building increases, calculating reduced harmonics with the correction coefficient β defined in Table B.7 is permitted.

Table B.7 Correction Coefficient according to the Building Scale

Contract demand (kW)	Correction coefficient β
300	1.00
500	0.90
1000	0.85
2000	0.80

Note: If the contract demand is between two specified values listed in Table B.7, calculate the value by interpolation.

Note: The correction coefficient β is to be determined as a matter of consultation between the customer and electric power supplier for the customers receiving the electric power over 2000 kW or from the special high voltage lines.

(4) Order of harmonics to be calculated

The higher the order of harmonics, the lower the current flows. This is the property of harmonics generated by inverters so that the inverters are covered by "The case without any special hazard" of the term (3) in the Guideline's Appendix 3.

Therefore, "It is sufficient that the 5th and 7th harmonic currents should be calculated."

[3] Examples of calculation

(1) Equivalent capacity

Example of loads	Input capacity and No. of inverters	Conversion factor	Equivalent capacity
[Example 1] 400V, 3.7 kW, 10 units w/ AC reactor and DC reactor	4.61 kVA × 10 units	K34 = 1.4	4.61 × 10 × 1.4 = 64.54 kVA
[Example 2] 400V, 1.5 kW, 15 units w/ DC reactor	1.95 kVA × 15 units	K33 = 1.8	1.95 × 15 × 1.8 = 52.65 kVA
	Refer to Table B.2.	Refer to Table B.3.	

(2) Harmonic current every orders

[Example 1] 400V, 3.7 kW 10 units, w/ AC reactor and DC reactor, and maximum availability: 0.55

Fundamental current onto 6.6 kV lines (mA)	Harmonic current onto 6.6 kV lines (mA)							
	5th (28%)	7th (9.1%)	11th (7.2%)	13th (4.1%)	17th (3.2%)	19th (2.4%)	23rd (1.6%)	25th (1.4%)
394 × 10 = 3940 3940 × 0.55 = 2167	606.8	197.2						
Refer to Tables B.4 and B.6.	Refer to Table B.5.							

[Example 2] 400V, 1.5 kW, 15 units, w/ DC reactor, and maximum availability: 0.55

Fundamental current onto 6.6 kV lines (mA)	Harmonic current onto 6.6 kV lines (mA)							
	5th (30%)	7th (13%)	11th (8.4%)	13th (5.0%)	17th (4.7%)	19th (3.2%)	23rd (3.0%)	25th (2.2%)
167 × 15 = 2505 2505 × 0.55 = 1378	413.4	179.2						
Refer to Tables B.4 and B.6.	Refer to Table B.5.							

App.C Effect on Insulation of General-purpose Motors Driven with 400 V Class Inverters

- Disclaimer: This document provides you with a summary of the Technical Document of the Japan Electrical Association (JEA) (March, 1995). It is intended to apply to the domestic market only. It is only for reference for the foreign market. -

Preface

When an inverter drives a motor, surge voltages generated by switching the inverter elements are superimposed on the inverter output voltage and applied to the motor terminals. If the surge voltages are too high they may have an effect on the motor insulation and some cases have resulted in damage.

For preventing such cases this document describes the generating mechanism of the surge voltages and countermeasures against them.

 Refer to A.2 [1] "Inverter noise" for details of the principle of inverter operation.

C.1 Generating mechanism of surge voltages

As the inverter rectifies a commercial power source voltage and smoothes into a DC voltage, the magnitude E of the DC voltage becomes about $\sqrt{2}$ times that of the source voltage (about 620V in case of an input voltage of 440 VAC). The peak value of the output voltage is usually close to this DC voltage value.

But, as there exists inductance (L) and stray capacitance (C) in wiring between the inverter and the motor, the voltage variation due to switching the inverter elements causes a surge voltage originating in LC resonance and results in the addition of high voltage to the motor terminals. (Refer to Figure C.1)

This voltage sometimes reaches up to about twice that of the inverter DC voltage ($620\text{V} \times 2 =$ approximately 1,200V) depending on a switching speed of the inverter elements and wiring conditions.

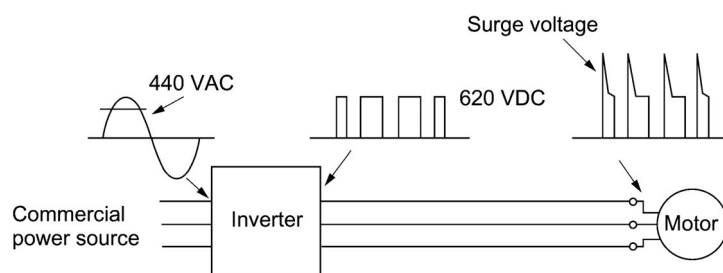
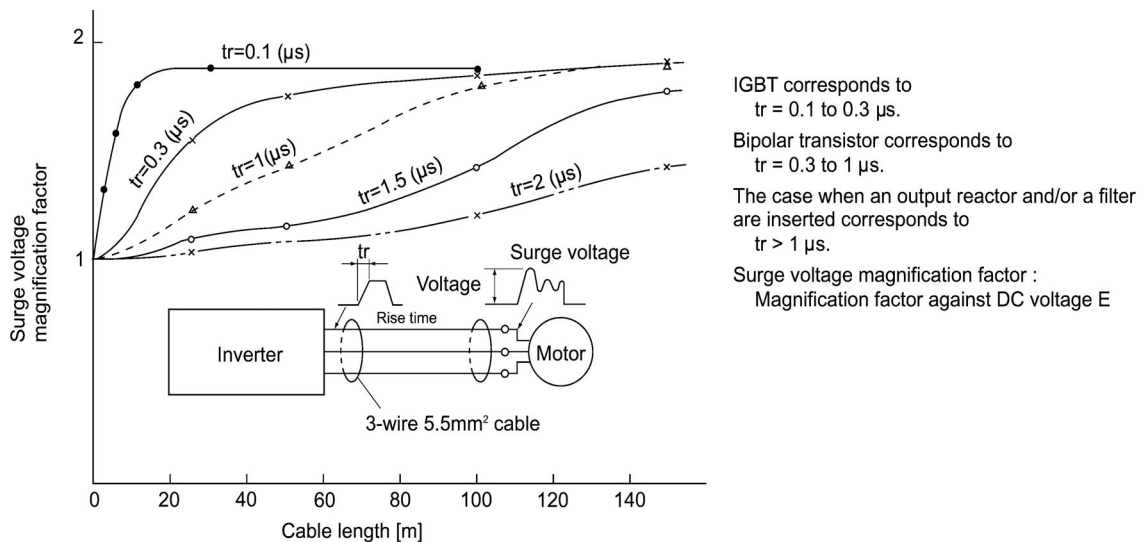

Figure C.1 Voltage Wave Shapes of Individual Portions

A measured example in Figure C.2 illustrates the relation of a peak value of the motor terminal voltage with a wiring length between the inverter and the motor.

From this it can be confirmed that the peak value of the motor terminal voltage ascends as the wiring length increases and becomes saturated at about twice the inverter DC voltage.

The shorter a pulse rise time becomes, the higher the motor terminal voltage rises even in the case of a short wiring length.



Excerpt from [J. IEE Japan, Vol. 107, No. 7, 1987]

Figure C.2 Measured Example of Wiring Length and Peak Value of Motor Terminal Voltage

C.2 Effect of surge voltages

The surge voltages originating in LC resonance of wiring may be applied to the motor input terminals and depending on their magnitude sometimes cause damage to the motor insulation.

When the motor is driven with a 200 V class inverter, the dielectric strength of the motor insulation has no problem even if the peak value of the motor terminal voltage increases twice at most due to the surge voltages since the DC link bus voltage is only approx. 300 V.

But in case of a 400 V class inverter the DC voltage to be switched is approximately 600 V and depending on the wiring length, the surge voltages may greatly increase (nearly at 1,200 V) and sometimes result in damage to the motor insulation.

C.3 Countermeasures against surge voltages

The following methods are countermeasures against damage to the motor insulation by the surge voltages and using a motor driven with a 400 V class inverter.

[1] Method using motors with enhanced insulation

Enhanced insulation of a motor winding allows its surge proof strength to be improved.

[2] Method to suppress surge voltages

There are two methods for suppressing the surge voltages, one is to reduce the voltage rise time and another is to reduce the voltage peak value.

(1) Output reactor

If wiring length is relatively short the surge voltages can be suppressed by reducing the voltage rise time (dv/dt) with the installation of an AC reactor on the output (secondary) side of the inverter. (Refer to Figure C.3 (1).)

However, if the wiring length becomes long, suppressing the peak voltage due to surges may be difficult for this countermeasure.

(2) Output filter

Installing a filter on the output side of the inverter allows a peak value of the motor terminal voltage to be reduced. (Refer to Figure C.3 (2).)

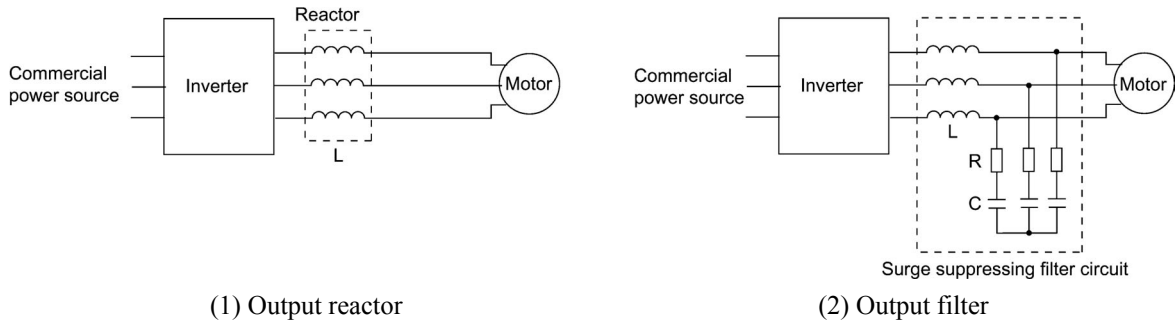

Figure C.3 Method to Suppress Surge Voltage

C.4 Regarding existing equipment

[1] In case of a motor being driven with 400 V class inverter

A survey over the several years on motor insulation damage due to the surge voltages originating from switching of inverter elements shows that the damage incidence is 0.013% under the surge voltage condition of over 1,100 V and most of the damage occurs several months after commissioning the inverter. Therefore there seems to be little probability of occurrence of motor insulation damage after a lapse of several months of commissioning.

[2] In case of an existing motor driven using a newly installed 400 V class inverter

We recommend suppressing the surge voltages with the method of Section C.3.

App.D Inverter Generating Loss

The table below lists the inverter generating loss.

Power supply voltage	Applicable motor rating (kW)	Inverter type	Generating loss (W)	
			Low carrier frequency ^{*1}	High carrier frequency ^{*2}
Three-phase 200 V	0.75	FRN0.75F1■-2□	50	60
	1.5	FRN1.5F1■-2□	79	110
	2.2	FRN2.2F1■-2□	110	140
	3.7	FRN3.7F1■-2□	167	210
	5.5	FRN5.5F1■-2□	210	280
	7.5	FRN7.5F1■-2□	320	410
	11	FRN11F1■-2□	410	520
	15	FRN15F1■-2□	550	660
	18.5	FRN18.5F1■-2□	670	800
	22	FRN22F1■-2□	810	970
	30	FRN30F1■-2□	1070	1190 ^{*3}
	37	FRN37F1■-2□	1700	1800 ^{*3}
	45	FRN45F1■-2□	1500	1650 ^{*3}
	55	FRN55F1■-2□	1900	2150 ^{*3}
	75	FRN75F1■-2□	2400	2700 ^{*3}
90	FRN90F1■-2□	3350	3500 ^{*4}	
110	FRN110F1■-2□	3950	4150 ^{*4}	
Three-phase 400 V	0.75	FRN0.75F1S-4E	45	82
	1.5	FRN1.5F1S-4E	60	110
	2.2	FRN2.2F1S-4E	80	150
	4.0	FRN4.0F1S-4E	130	230
	5.5	FRN5.5F1S-4E	160	280
	7.5	FRN7.5F1S-4E	220	370
	11	FRN11F1S-4E	340	530
	15	FRN15F1S-4E	450	700
	18.5	FRN18.5F1S-4E	460	790
	22	FRN22F1S-4E	570	970
	30	FRN30F1S-4E	950	1200 ^{*3}
	37	FRN37F1S-4E	1150	1450 ^{*3}
	45	FRN45F1S-4E	1300	1600 ^{*3}
	55	FRN55F1S-4E	1350	1700 ^{*3}
	75	FRN75F1S-4E	1550	2050 ^{*3}
	90	FRN90F1S-4E	1850	2100 ^{*4}
	110	FRN110F1S-4E	2200	2500 ^{*4}
	132	FRN132F1S-4E	2550	2900 ^{*4}
	160	FRN160F1S-4E	3150	3550 ^{*4}
	200	FRN200F1S-4E	3800	4350 ^{*4}
220	FRN220F1S-4E	4350	4950 ^{*4}	
280	FRN280F1S-4E	5350	5950 ^{*4}	
315	FRN315F1S-4E	6000	6650 ^{*4}	
355	FRN355F1S-4E	6950	7700 ^{*4}	
400	FRN400F1S-4E	7800	8600 ^{*4}	
450	FRN450F1S-4E	8550	9600 ^{*4}	
500	FRN500F1S-4E	9600	10750 ^{*4}	
560	FRN560F1S-4E	10800	12000 ^{*4}	

Note 1) The carrier frequency f_c is: 2 kHz for *1, 15 kHz for *2, 10 kHz for *3, and 6 kHz for *4

2) A box (■) in the above table replaces S (Standard type), E (EMC filter built-in type), H (DCR built-in type) or B or D/L (Waterproof type) depending on the product specifications.

3) A box (□) in the above table replaces A, C, E, or J depending on the shipping destination.

App.E Conversion from SI Units

All expressions given in Chapter 7, "SELECTING OPTIMAL MOTOR AND INVERTER CAPACITIES" are based on SI units (International System of Units). This section explains how to convert expressions to other units.

[1] Conversion of units

(1) Force

- $1 \text{ (kgf)} \approx 9.8 \text{ (N)}$
- $1 \text{ (N)} \approx 0.102 \text{ (kgf)}$

(2) Torque

- $1 \text{ (kgf}\cdot\text{m)} \approx 9.8 \text{ (N}\cdot\text{m)}$
- $1 \text{ (N}\cdot\text{m)} \approx 0.102 \text{ (kgf}\cdot\text{m)}$

(3) Work and Energy

- $1 \text{ (kgf}\cdot\text{m)} \approx 9.8 \text{ (N}\cdot\text{m)} = 9.8 \text{ (J)} = 9.8 \text{ (W}\cdot\text{s)}$

(4) Power

- $1 \text{ (kgf}\cdot\text{m/s)} \approx 9.8 \text{ (N}\cdot\text{m/s)} = 9.8 \text{ (J/s)} = 9.8 \text{ (W)}$
- $1 \text{ (N}\cdot\text{m/s)} \approx 1 \text{ (J/s)} = 1 \text{ (W)} \approx 0.102 \text{ (kgf}\cdot\text{m/s)}$

(5) Rotation speed

- $1 \text{ (r/min)} = \frac{2\pi}{60} \text{ (rad/s)} \approx 0.1047 \text{ (rad/s)}$
- $1 \text{ (rad/s)} = \frac{60}{2\pi} \text{ (r/min)} \approx 9.549 \text{ (r/min)}$

(6) Inertia constant

- $J \text{ (kg}\cdot\text{m}^2)$:moment of inertia
- $GD^2 \text{ (kg}\cdot\text{m}^2)$:flywheel effect

- $GD^2 = 4 J$

- $J = \frac{GD^2}{4}$

(7) Pressure and stress

- $1 \text{ (mmAq)} \approx 9.8 \text{ (Pa)} \approx 9.8 \text{ (N/m}^2)$
- $1 \text{ (Pa)} \approx 1 \text{ (N/m}^2) \approx 0.102 \text{ (mmAq)}$
- $1 \text{ (bar)} \approx 100000 \text{ (Pa)} \approx 1.02 \text{ (kg}\cdot\text{cm}^2)$
- $1 \text{ (kg}\cdot\text{cm}^2) \approx 98000 \text{ (Pa)} \approx 980 \text{ (mbar)}$
- $1 \text{ atmospheric pressure} = 1013 \text{ (mbar)} = 760 \text{ (mmHg)} = 101300 \text{ (Pa)} \approx 1.033 \text{ (kg/cm}^2)$

[2] Calculation formula

(1) Torque, power, and rotation speed

- $P (W) \approx \frac{2\pi}{60} \cdot N (r/min) \cdot \tau (N \cdot m)$
- $P (W) \approx 1.026 \cdot N (r/min) \cdot T (kgf \cdot m)$
- $\tau (N \cdot m) \approx 9.55 \cdot \frac{P (W)}{N (r/min)}$
- $T (kgf \cdot m) \approx 0.974 \cdot \frac{P (W)}{N (r/min)}$

(2) Kinetic energy

- $E (J) \approx \frac{1}{182.4} \cdot J (kg \cdot m^2) \cdot N^2 [(r/min)^2]$
- $E (J) \approx \frac{1}{730} \cdot GD^2 (kg \cdot m^2) \cdot N^2 [(r/min)^2]$

(3) Torque of linear moving load

Driving mode

- $\tau (N \cdot m) \approx 0.159 \cdot \frac{V (m/min)}{N_M (r/min) \cdot \eta_G} \cdot F (N)$
- $T (kgf \cdot m) \approx 0.159 \cdot \frac{V (m/min)}{N_M (r/min) \cdot \eta_G} \cdot F (kgf)$

Braking mode

- $\tau (N \cdot m) \approx 0.159 \cdot \frac{V (m/min)}{N_M (r/min) / \eta_G} \cdot F (N)$
- $T (kgf \cdot m) \approx 0.159 \cdot \frac{V (m/min)}{N_M (r/min) / \eta_G} \cdot F (kgf)$

(4) Acceleration torque

Driving mode

- $\tau (N \cdot m) \approx \frac{J (kg \cdot m^2)}{9.55} \cdot \frac{\Delta N (r/min)}{\Delta t (s) \cdot \eta_G}$
- $T (kgf \cdot m) \approx \frac{GD^2 (kg \cdot m^2)}{375} \cdot \frac{\Delta N (r/min)}{\Delta t (s) \cdot \eta_G}$

Braking mode

- $\tau (N \cdot m) \approx \frac{J (kg \cdot m^2)}{9.55} \cdot \frac{\Delta N (r/min) \cdot \eta_G}{\Delta t (s)}$
- $T (kgf \cdot m) \approx \frac{GD^2 (kg \cdot m^2)}{375} \cdot \frac{\Delta N (r/min) \cdot \eta_G}{\Delta t (s)}$

(5) Acceleration time

- $t_{ACC} (s) \approx \frac{J_1 + J_2 / \eta_G (kg \cdot m^2)}{\tau_M - \tau_L / \eta_G (N \cdot m)} \cdot \frac{\Delta N (r/min)}{9.55}$
- $t_{ACC} (s) \approx \frac{GD_1^2 + GD_2^2 / \eta_G (kg \cdot m^2)}{T_M - T_L / \eta_G (kgf \cdot m)} \cdot \frac{\Delta N (r/min)}{375}$

(6) Deceleration time

- $t_{DEC} (s) \approx \frac{J_1 + J_2 \cdot \eta_G (kg \cdot m^2)}{\tau_M - \tau_L \cdot \eta_G (N \cdot m)} \cdot \frac{\Delta N (r/min)}{9.55}$
- $t_{DEC} (s) \approx \frac{GD_1^2 + GD_2^2 \cdot \eta_G (kg \cdot m^2)}{T_M - T_L \cdot \eta_G (kgf \cdot m)} \cdot \frac{\Delta N (r/min)}{375}$

App.F Allowable Current of Insulated Wires

The tables below list the allowable current of IV wires, HIV wires, and 600 V class of cross-linked polyethylene-insulated wires.

■ IV wires (Maximum allowable temperature: 60°C)

Table F.1 (a) Allowable Current of Insulated Wires

Wire size (mm ²)	Allowable current reference value (up to 30°C) I ₀ (A)	Wiring outside duct					Wiring in the duct (Max. 3 wires in one duct)			
		35°C (I ₀ ×0.91) (A)	40°C (I ₀ ×0.82) (A)	45°C (I ₀ ×0.71) (A)	50°C (I ₀ ×0.58) (A)	55°C (I ₀ ×0.40) (A)	35°C (I ₀ ×0.63) (A)	40°C (I ₀ ×0.57) (A)	45°C (I ₀ ×0.49) (A)	50°C (I ₀ ×0.40) (A)
2.0	27	24	22	19	15	11	17	15	13	10
3.5	37	33	30	26	21	15	23	21	18	14
5.5	49	44	40	34	28	20	30	27	24	19
8.0	61	55	50	43	35	25	38	34	29	24
14	88	80	72	62	51	36	55	50	43	35
22	115	104	94	81	66	47	72	65	56	46
38	162	147	132	115	93	66	102	92	79	64
60	217	197	177	154	125	88	136	123	106	86
100	298	271	244	211	172	122	187	169	146	119
150	395	359	323	280	229	161	248	225	193	158
200	469	426	384	332	272	192	295	267	229	187
250	556	505	455	394	322	227	350	316	272	222
325	650	591	533	461	377	266	409	370	318	260
400	745	677	610	528	432	305	469	424	365	298
500	842	766	690	597	488	345	530	479	412	336
2 x 100	497	452	407	352	288	203	313	283	243	198
2 x 150	658	598	539	467	381	269	414	375	322	263
2 x 200	782	711	641	555	453	320	492	445	383	312
2 x 250	927	843	760	658	537	380	584	528	454	370
2 x 325	1083	985	888	768	628	444	682	617	530	433
2 x 400	1242	1130	1018	881	720	509	782	707	608	496
2 x 500	1403	1276	1150	996	813	575	883	799	687	561

■ HIV wires (Maximum allowable temperature: 75°C)

Table F.1 (b) Allowable Current of Insulated Wires

Wire size (mm ²)	Allowable current reference value (up to 30°C) I ₀ (A)	Wiring outside duct					Wiring in the duct (Max. 3 wires in one duct)			
		35°C (I ₀ ×0.91) (A)	40°C (I ₀ ×0.82) (A)	45°C (I ₀ ×0.71) (A)	50°C (I ₀ ×0.58) (A)	55°C (I ₀ ×0.40) (A)	35°C (I ₀ ×0.63) (A)	40°C (I ₀ ×0.57) (A)	45°C (I ₀ ×0.49) (A)	50°C (I ₀ ×0.40) (A)
2.0	32	31	29	27	24	22	21	20	18	17
3.5	45	42	39	37	33	30	29	27	25	23
5.5	59	56	52	49	44	40	39	36	34	30
8.0	74	70	65	61	55	50	48	45	42	38
14	107	101	95	88	80	72	70	66	61	55
22	140	132	124	115	104	94	92	86	80	72
38	197	186	174	162	147	132	129	121	113	102
60	264	249	234	217	197	177	173	162	151	136
100	363	342	321	298	271	244	238	223	208	187
150	481	454	426	395	359	323	316	296	276	248
200	572	539	506	469	426	384	375	351	328	295
250	678	639	600	556	505	455	444	417	389	350
325	793	747	702	650	591	533	520	487	455	409
400	908	856	804	745	677	610	596	558	521	469
500	1027	968	909	842	766	690	673	631	589	530
2 x 100	606	571	536	497	452	407	397	372	347	313
2 x 150	802	756	710	658	598	539	526	493	460	414
2 x 200	954	899	844	782	711	641	625	586	547	492
2 x 250	1130	1066	1001	927	843	760	741	695	648	584
2 x 325	1321	1245	1169	1083	985	888	866	812	758	682
2 x 400	1515	1428	1341	1242	1130	1018	993	931	869	782
2 x 500	1711	1613	1515	1403	1276	1150	1122	1052	982	883

App.

■ 600 V class of Cross-linked Polyethylene-insulated wires (Maximum allowable temperature: 90°C)

Table F.1 (c) Allowable Current of Insulated Wires

Wire size (mm ²)	Allowable current reference value (up to 30°C) I ₀ (A)	Wiring outside duct					Wiring in the duct (Max. 3 wires in one duct)			
		35°C (I ₀ ×0.91) (A)	40°C (I ₀ ×0.82) (A)	45°C (I ₀ ×0.71) (A)	50°C (I ₀ ×0.58) (A)	55°C (I ₀ ×0.40) (A)	35°C (I ₀ ×0.63) (A)	40°C (I ₀ ×0.57) (A)	45°C (I ₀ ×0.49) (A)	50°C (I ₀ ×0.40) (A)
2.0	38	36	34	32	31	29	25	24	22	21
3.5	52	49	47	45	42	39	34	33	31	29
5.5	69	66	63	59	56	52	46	44	41	39
8.0	86	82	78	74	70	65	57	54	51	48
14	124	118	113	107	101	95	82	79	74	70
22	162	155	148	140	132	124	108	103	97	92
38	228	218	208	197	186	174	152	145	137	129
60	305	292	279	264	249	234	203	195	184	173
100	420	402	384	363	342	321	280	268	253	238
150	556	533	509	481	454	426	371	355	335	316
200	661	633	605	572	539	506	440	422	398	375
250	783	750	717	678	639	600	522	500	472	444
325	916	877	838	793	747	702	611	585	552	520
400	1050	1005	961	908	856	804	700	670	633	596
500	1187	1136	1086	1027	968	909	791	757	715	673
2 x 100	700	670	641	606	571	536	467	447	422	397
2 x 150	927	888	848	802	756	710	618	592	559	526
2 x 200	1102	1055	1008	954	899	844	735	703	664	625
2 x 250	1307	1251	1195	1130	1066	1001	871	834	787	741
2 x 325	1527	1462	1397	1321	1245	1169	1018	974	920	866
2 x 400	1751	1676	1602	1515	1428	1341	1167	1117	1055	993
2 x 500	1978	1894	1809	1711	1613	1515	1318	1262	1192	1122

Glossary

This glossary explains the technical terms that are frequently used in this manual.

Acceleration time

Period required when an inverter accelerates its output from 0 Hz to the output frequency.

Related function codes: F03, F07, E10, and H54

Alarm mode

One of the three operation modes supported by the inverter. If the inverter detects any malfunction, error, or fault in its operation, it immediately shuts down or trips the output to the motor and enters this mode in which corresponding alarm codes are displayed on the LED monitor.

Alarm output (for any faults)

A mechanical contact output signal that is generated when the inverter is halted by an alarm, by short-circuiting between terminals [30A] and [30C].

Related function code: E27

See Alarm mode.

Analog input

An external voltage or current input signal to give the inverter the frequency command. The analog voltage is applied on the terminal [11] or [V2], the current on the [C1]. These terminals are also used to input the signal from the external potentiometer, PTC and PID feedback signals depending on the function code definition.

Related function codes: F01, C30, E60 to E62 and J02

Analog output

An analog DC output signal of the monitored data such as the output frequency, the current and voltage inside an inverter. The signal drive an analog meter installed outside the inverter for indicating the current inverter running status.

Refer to Chapter 8, Section 8.4.1 "Terminal functions."

Applicable motor rating

Rated output (in kW) of a general-purpose motor that is used as a standard motor listed in tables in Chapter 6, "SELECTING PERIPHERAL EQUIPMENT" and Chapter 8, "SPECIFICATIONS."

Automatic deceleration

A control mode in which deceleration time is automatically extended up to 3 times of the commanded time to prevent the inverter from tripping due to an overvoltage caused by regenerative power even if a braking resistor is used.

Related function code: H69

Automatic energy saving operation

Energy saving operation that automatically drives the motor with lower output voltage when the motor load has been light, for minimizing the product of voltage and current (electric power).

Related function code: F37

AVR (Automatic Voltage Regulator) control

A control that keeps an output voltage constant regardless to variations of the input source voltage or load.

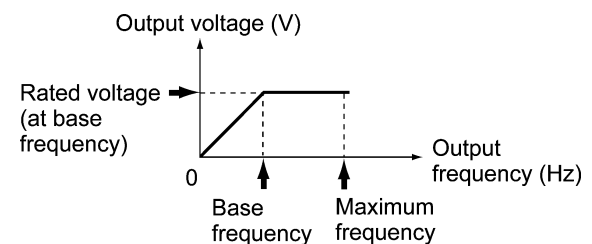
Base frequency

The minimum frequency at which an inverter delivers a constant voltage in the output V/f pattern.

Related function code: F04

Bias

A value to be added to an analog input frequency to modify and produce the output frequency.

Related function codes: F18, C50 to C52

Braking torque

Torque that acts in a direction that will stop a rotating motor (or the force required to stop a running motor).

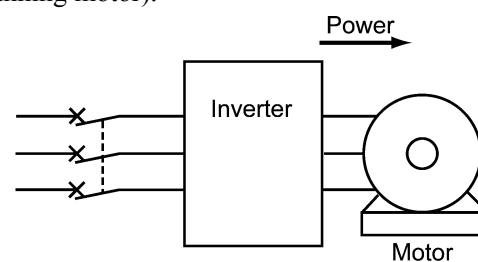

During accelerating or running at constant speed

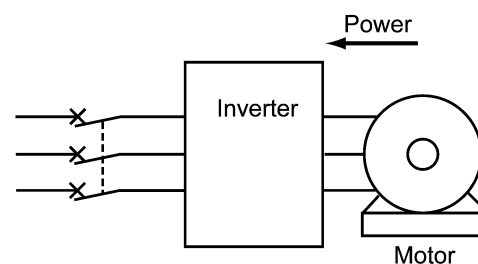

During decelerating

If a deceleration time is shorter than the natural stopping time (coast-to-stop) determined by a moment of inertia for a load machine, then the motor works as a generator when it decelerates, causing the kinetic energy of the load to be converted to electrical energy that is returned to the inverter from the motor. If this power (regenerative power) is consumed or accumulated by the inverter, the motor generates a braking force called "braking torque."

Carrier frequency

Frequency used to modulate a modulated frequency to establish the modulation period of a pulse width under the PWM control system. The higher the carrier frequency, the closer the inverter output current approaches a sinusoidal waveform and the quieter the motor becomes.
Related function code: F26

Coast-to-stop

If the inverter stops its output when the motor is running, the motor will coast to a stop due to inertial force.

Communications link function

A feature to control an inverter from external equipment serially linked to the inverter such as a PC or PLC.
Related function code: H30

Constant feeding rate time

Time required for an object to move in a constant distance previously defined. The faster speed, the shorter time and vice versa. This facility may be applied to a chemical process that determines a processing time of materials as the speed such as heating, cooling, drying, or doping in some constant-speed machinery.
Related function codes: E50.

Constant output load

A constant output load is characterized by:
1) The required torque is in inverse proportion to the load r/min
2) An essentially constant power requirement
Related function code: F37
Applications: Machine tool spindles

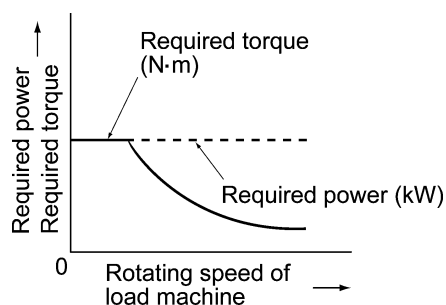

Constant torque load

A constant torque load is characterized by:
1) A requirement for an essentially constant torque, regardless of the r/min
2) A power requirement that decreases in proportion to the r/min
Related function code: F37
Applications: Conveyors, elevators, and transport machines

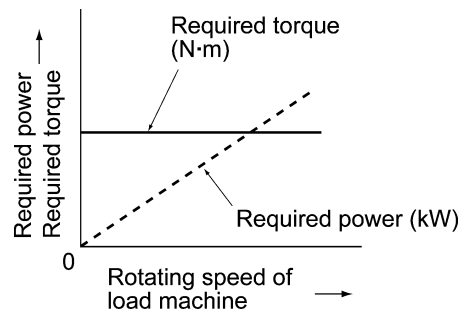

Control circuit terminals

Terminals on the inverter, which are used for input/output of signals to control or manage the inverter/external equipment directly or indirectly

Current limiter

A device that keeps an inverter output frequency within the specified current limit.

Cursor

Marker blinking on the four-digit, 7-segment LED monitor which shows that data in the blinking digit can be changed/modified by keying operation.

Curvilinear V/f pattern

A generic name for the inverter output patterns with curvilinear relation between the frequency and voltage.
Refer to function code H07 in Chapter 9, Section 9.2.5 "H codes."

DC braking

DC current braking that an inverter injects into the motor to brake and stop it against the moment of inertia of the motor or its load. The inertial energy generated is consumed as heat in the motor.
If a motor having the load with large moment of inertia is going to stop abruptly, the moment of inertia may force to rotate the motor after the inverter output frequency has been reduced to 0 Hz. Use DC braking to stop the motor completely.
Related function codes: F20 and F21

DC link bus voltage

Voltage at the DC link bus that is the end stage of the converter part of inverters. The part rectifies the input AC power to charge the DC link bus capacitor/s as the DC power to be inverted to AC power.

Deceleration time

Period during which an inverter slows its output frequency down from the maximum to 0 Hz.

Related function codes: F03, F08, E11, and H54

Digital input

Input signals given to the programmable input terminals or the programmable input terminals themselves. A command assigned to the digital input is called the terminal command to control the inverter externally.

Refer to Chapter 8, Section 8.4.1 "Terminal functions."

Electronic thermal overload protection

Electronic thermal overload protection to issue an early warning of the motor overheating to safeguard a motor.

An inverter calculates the motor overheat condition based on the internal data (given by function code P99 about the properties of the motor) and the driving conditions such as the drive current, voltage and frequency.

External potentiometer

A potentiometer (optional) that is used to set frequencies as well as built-in one.

Fan stop operation

A mode of control in which the cooling fan is shut down if the internal temperature in the inverter is low and when no operation command is issued.

Related function code: H06

Frequency accuracy (stability)

The percentage of variations in output frequency to a predefined maximum frequency.

Frequency limiter

Frequency limiter used inside the inverter to control the internal drive frequency in order to keep the motor speed within the specified level between the high and low frequency.

Related function codes: F15, F16, and H64

Frequency resolution

The minimum step, or increment, in which output frequency is varied, rather than continuously.

Function code

Code to customize the inverter. Setting function codes realizes the potential capability of the inverter to meet it for the individual power system applications.

Gain (for frequency command)

A frequency command gain enables varying the slope of the reference frequency specified by an analog input signal.

Related function codes: C32, C34, C37, and C39

IGBT (Insulated Gate Bipolar Transistor)

Stands for Insulated Gate Bipolar Transistor that enables the inverter section to switch high voltage/current DC power in very high speed and to output pulse train.

Interphase unbalance

A condition of an AC input voltage (supply voltage) that states the voltage balance of each phase in an expression as:

$$\begin{aligned} & \text{Interphase voltage unbalance (\%)} \\ & = \frac{\text{Max.voltage (V)} - \text{Min.voltage (V)}}{\text{3-phase average voltage (V)}} \times 67 \end{aligned}$$

Inverse mode operation

A mode of operation in which the output frequency lowers as the analog input signal level rises.

Jogging operation

A special operation mode of inverters, in which a motor jogs forward or reverse for a short time at a slower speed than usual operating modes.

Related function codes: F03, C20, and H54

Jump frequencies

Frequencies that have a certain output with no change in the output frequency within the specified frequency band in order to skip the resonance frequency band of a machine.

Related function codes: C01 to C04

Keypad operation

To use a keypad to run an inverter.

Line speed

Running speed of an object (e.g., conveyor) driven by the motor. The unit is meter per minute, m/min.

Load shaft speed

Number of revolutions per minute (r/min) of a rotating load driven by the motor, such as a fan.

Main circuit terminals

Power input/output terminals of an inverter, which includes terminals to connect the power source, motor, DC reactor, braking resistor, and other power components.

Maximum frequency

The output frequency commanded by the input of the maximum value of a reference frequency setup signal (for example, 10 V for a voltage input range of 0 to 10 V or 20 mA for a current input range of 4 to 20 mA).

Related function code: F03

Modbus RTU

Communication protocol used in global FA network market, which is developed by Modicon, Inc. USA.

Momentary voltage drop immunity

The minimum voltage (V) and time (ms) that permit continued rotation of the motor after a momentary voltage drop (instantaneous power failure).

Multistep frequency selection

To preset frequencies (up to 7 stages), then select them at some later time using external signals.

Related function codes: E01 to E03, C05 to C11

Overload capability

The overload current that an inverter can tolerate, expressed as a percentage of the rated output current and also as a permissible energization time.

PID control

The scheme of control that brings controlled objects to a desired value quickly and accurately, and which consists of three categories of action: proportional, integral and derivative.

Proportional action minimizes errors from a set point. Integral action resets errors from a desired value to 0. Derivative action applies a control value in proportion to a differential component of the difference between the PID reference and feedback values. (See Chapter 4, Figure 4.7.)

Related function codes: E01 to E03, E40, E41, E43, E60 to E62, C51, C52, J01 to J06

Programming mode

One of the three operation modes supported by the inverter. This mode uses the menu-driven system and allows the user to set function codes or check the inverter status/maintenance information.

PTC (Positive Temperature Coefficient)

thermistor

Type of thermistor with a positive temperature coefficient. Used to safeguard a motor.

Related function codes: H26 and H27

Rated capacity

The rating of an inverter output capacity (at the secondary side), or the apparent power that is represented by the rated output voltage times the rated output current, which is calculated by solving the following equation and is stated in kVA:

$$\begin{aligned} \text{Rated capacity (kVA)} \\ &= \sqrt{3} \times \text{Rated output voltage (V)} \\ &\quad \times \text{Rated output current (A)} \times 10^{-3} \end{aligned}$$

The rated output voltage is assumed to be 220 V for 200 V class equipment and 440 V for 400 V class equipment.

Rated output current

A total RMS equivalent to the current that flows through the output terminal under the rated input and output conditions (the output voltage, current, frequency, and load factor meet their rated conditions). Essentially, equipment rated at 200 V covers the current of a 200 V, 50 Hz 6-pole motor and equipment rated at 400 V covers the current of a 380 V, 50 Hz 4-pole motor.

Rated output voltage

A fundamental wave RMS equivalent to the voltage that is generated across the output terminal when the AC input voltage (supply voltage) and frequency meet their rated conditions and the output frequency of the inverter equals the base frequency.

Required power supply capacity

The capacity required of a power supply for an inverter. This is calculated by solving either of the following equations and is stated in kVA:

$$\begin{aligned} \text{Required power supply capacity (kVA)} \\ &= \sqrt{3} \times 200 \times \text{Input RMS current (200V, 50Hz)} \\ &\text{or} \\ &= \sqrt{3} \times 220 \times \text{Input RMS current (220V, 60Hz)} \end{aligned}$$

$$\begin{aligned} \text{Required power supply capacity (kVA)} \\ &= \sqrt{3} \times 400 \times \text{Input RMS current (400V, 50Hz)} \\ &\text{or} \\ &= \sqrt{3} \times 440 \times \text{Input RMS current (40V, 60Hz)} \end{aligned}$$

Running mode

One of the three operation modes supported by the inverter. If the inverter is turned ON, it automatically enters this mode which you may: run/stop the motor, set up the reference frequency, monitor the running status, and jog the motor.

S-curve acceleration/deceleration**(weak/strong)**

To reduce the impact on the inverter driven machine during acceleration/deceleration, the inverter gradually accelerates/decelerates the motor at the both ends of the acceleration/deceleration zones like a figure of S letter.

Related function code: H07

Slip compensation control

A mode of control in which the output frequency of an inverter plus an amount of slip compensation is used as an actual output frequency to compensate for motor slippage.

Related function code: P09

Stall

A behavior of a motor when it loses speed by tripping of the inverter due to overcurrent detection or other malfunctions of the inverter.

Starting frequency

The minimum frequency at which an inverter starts its output (not the frequency at which a motor starts rotating).

Related function code: F23

Starting torque

Torque that a motor produces when it starts rotating (or the drive torque with which the motor can run a load).

Simultaneous keying

To simultaneously press the 2 keys on the keypad. This presents the special function of inverters.

Stop frequency

The output frequency at which an inverter stops its output.

Related function code: F25

Thermal time constant

The time needed to activate the electronic thermal overload protection after the preset operation level (current) continuously flows. This is an adjustable function code data to meet the property of a motor that is not manufactured by Fuji Electric.

Related function code: F12

Torque boost

If a general-purpose motor is run with an inverter, voltage drops will have a pronounced effect in a low-frequency region, reducing the motor output torque. In a low-frequency range, therefore, to increase the motor output torque, it is necessary to augment the output voltage. This process of voltage compensation is called torque boost.

Related function code: F09

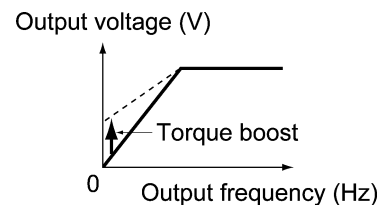
**Transistor output**

A control signal that generates predefined data from within an inverter via a transistor (open collector).

Trip

In response to an overvoltage, overcurrent, or any other unusual condition, actuation of an inverter's protective circuit to stop the inverter output.

V/f characteristic

A characteristic expression of the variations in output voltage V (V), and relative to variations in output frequency f (Hz). To achieve efficient motor operation, an appropriate V/f (voltage/frequency) characteristic helps a motor produce its output torque matching the torque characteristics of a load.

V/f control

The rotating speed N (r/min) of a motor can be stated in an expression as

$$N = \frac{120 \times f}{p} \times (1-s)$$

where,

f: Output frequency

p: Number of poles

s: Slippage

On the basis of this expression, varying the output frequency varies the speed of the motor. However, simply varying the output frequency f (Hz) would result in an overheated motor or would not allow the motor to demonstrate its optimum utility if the output voltage V (V) remains constant. For this reason, the output voltage V must be varied with the output frequency f by using an inverter. This scheme of control is called V/f control.

Variable torque load

A squared torque load is characterized by:

- 1) A change in the required torque in proportion to the square of the number of revolutions per minute.
- 2) A power requirement that decreases in proportion to the cube of the decrease in the number of revolutions per minute.

$$\begin{aligned} &\text{Required power (kW)} \\ &= \frac{\text{Rotating speed (r/min)} \times \text{Torque (N}\cdot\text{m)}}{9.55} \end{aligned}$$

Related function code: F37

Applications: Fans and pumps

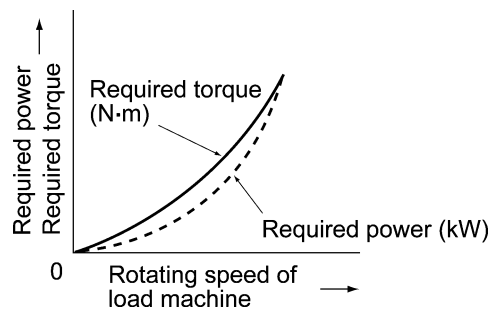

Voltage and frequency variations

Variations in the input voltage or frequency within permissible limits. Variations outside these limits might cause an inverter or motor to fail.

Designed For Fan and Pump Applications

FRENIC-ECO

User's Manual

First Edition, March 2005

Third Edition, May 2007

Fuji Electric Systems Co., Ltd.

The purpose of this manual is to provide accurate information in the handling, setting up and operating of the FRENIC-Eco series of inverters. Please feel free to send your comments regarding any errors or omissions you may have found, or any suggestions you may have for generally improving the manual.

In no event will Fuji Electric Systems Co., Ltd. be liable for any direct or indirect damages resulting from the application of the information in this manual.

Fuji Electric Systems Co., Ltd.

Gate City Ohsaki, East Tower, 11-2, Osaki 1-chome
Shinagawa-ku, Tokyo 141-0032, Japan
Phone: +81-3-5435-7283 Fax: +81-3-5435-7425